

Cube

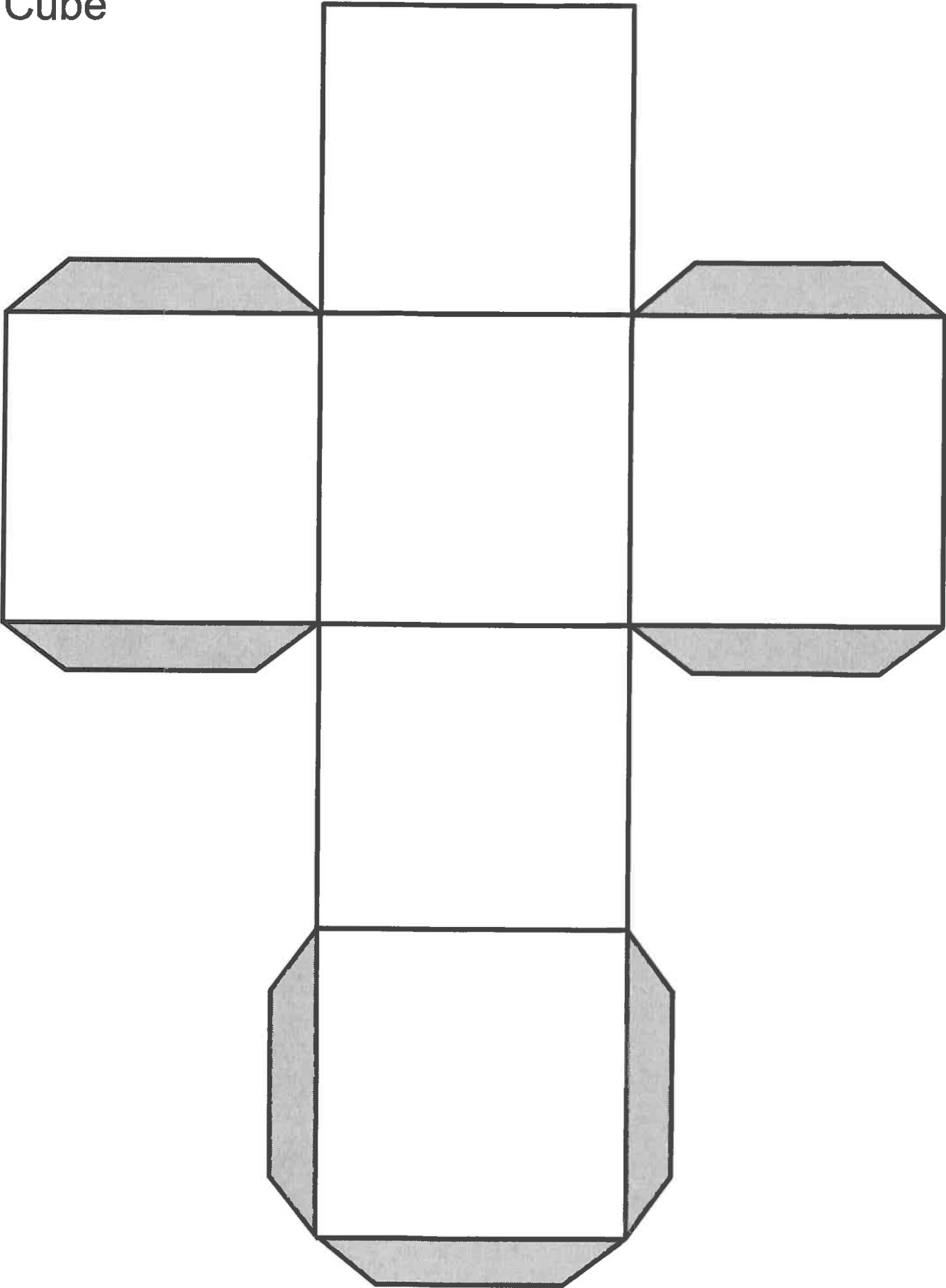

Cuboid

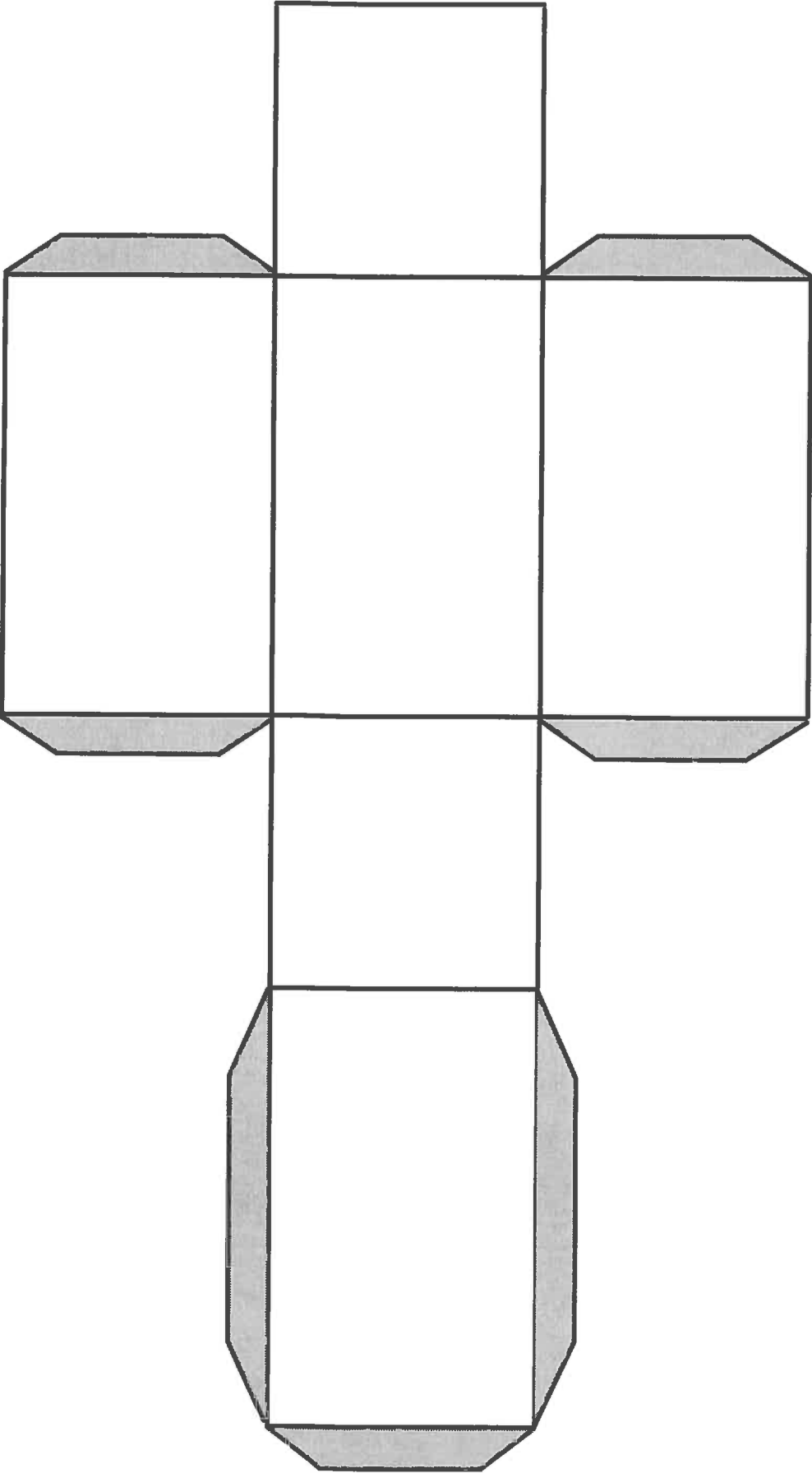

Pyramid

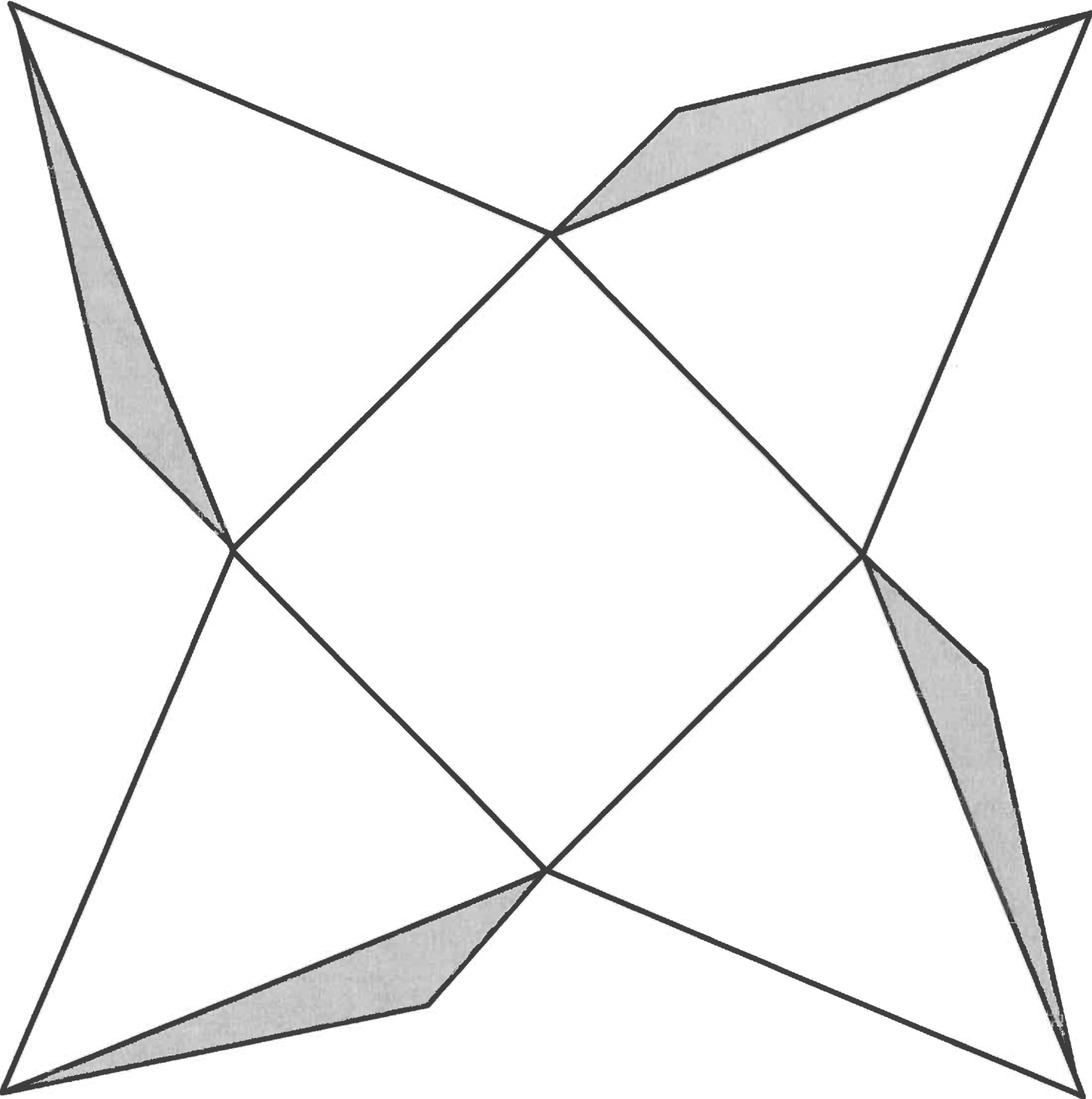

Cone

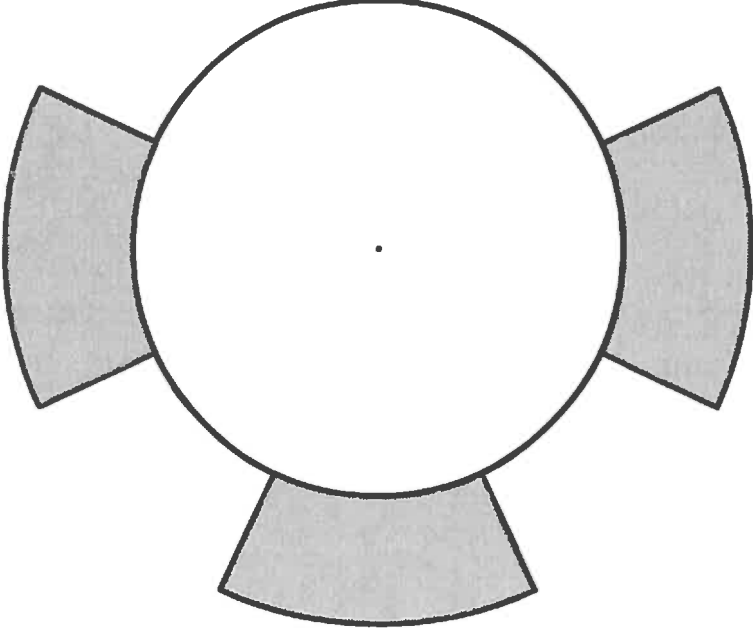
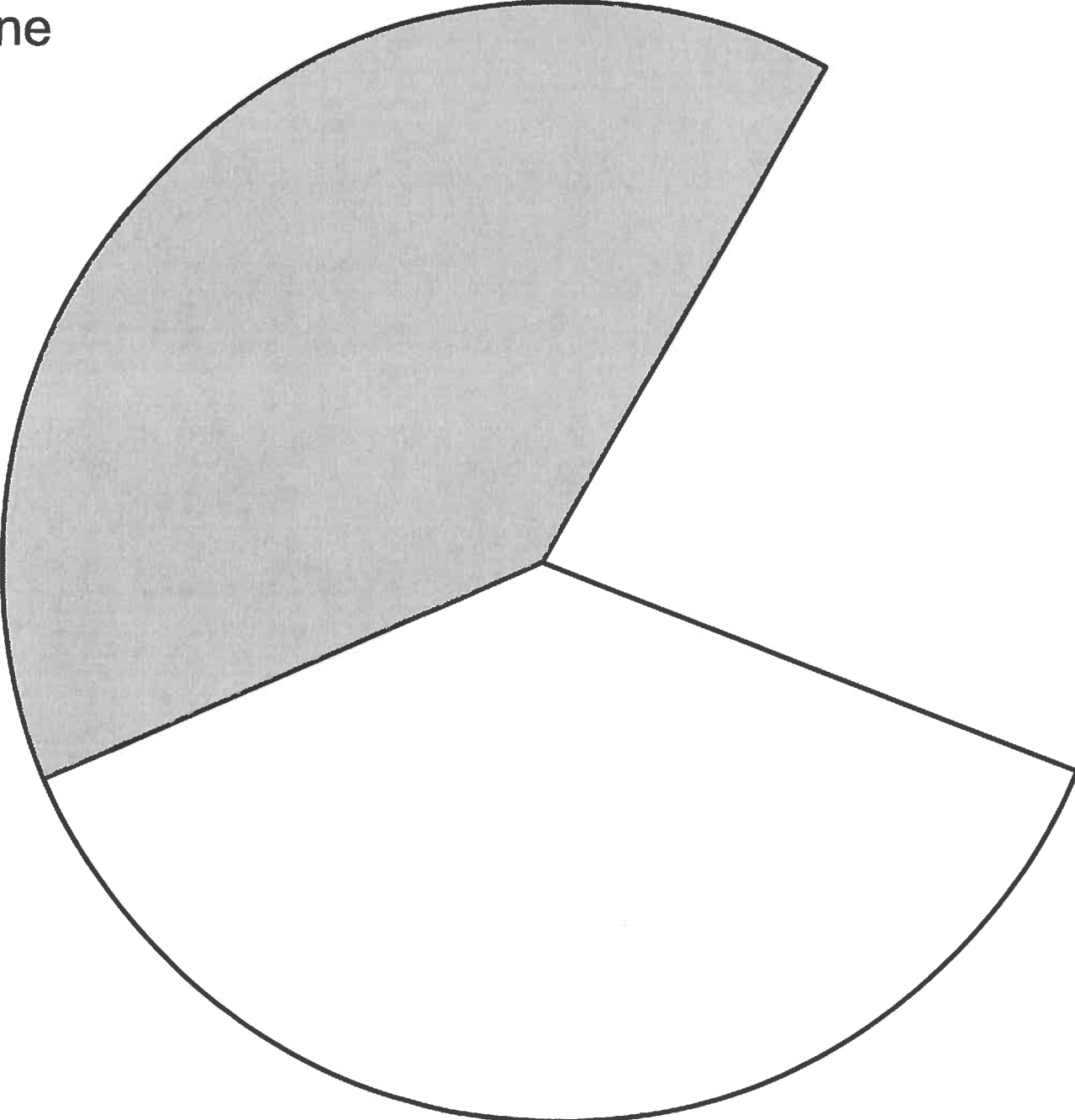

Tetrahedron

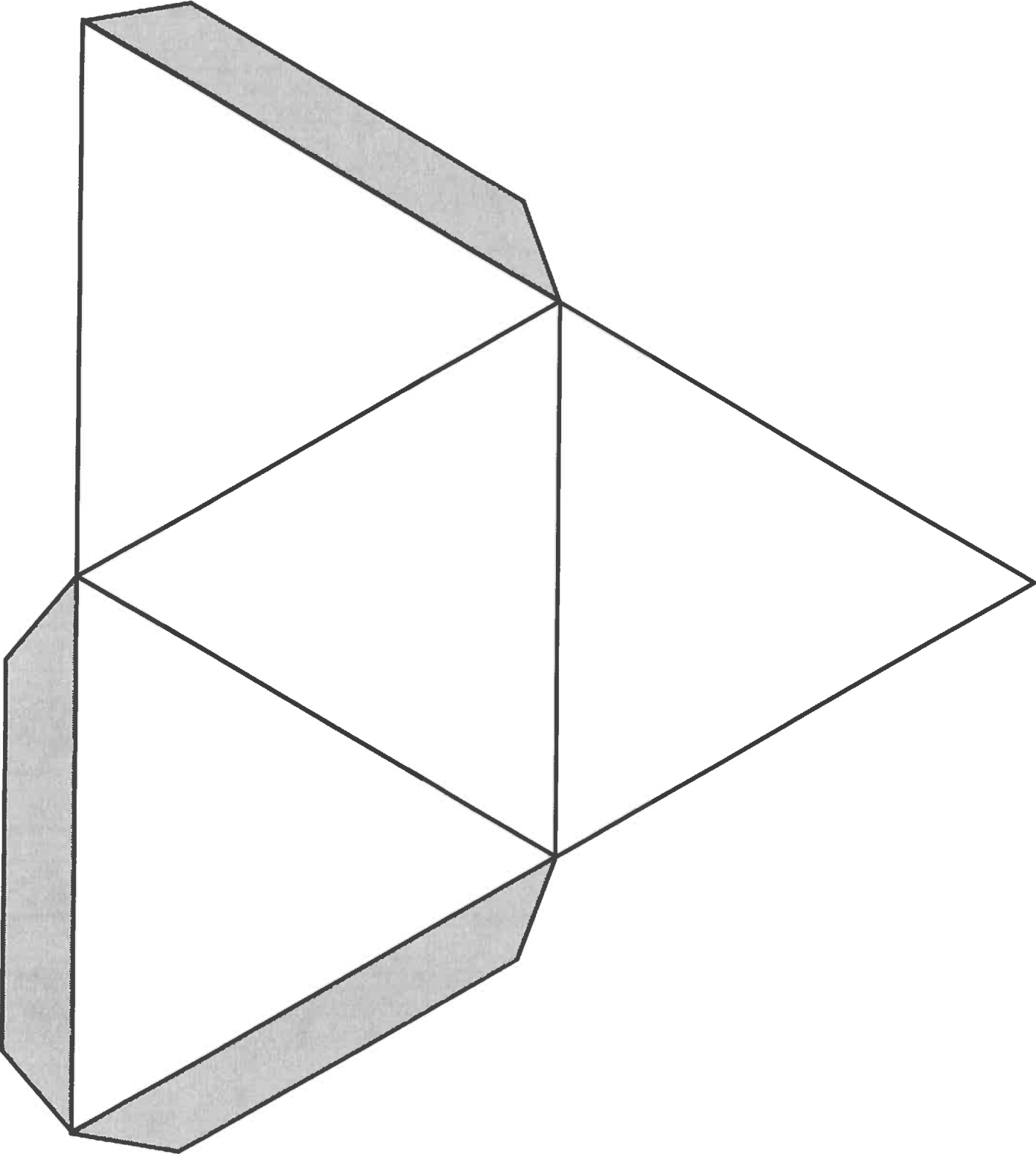

Cylinder

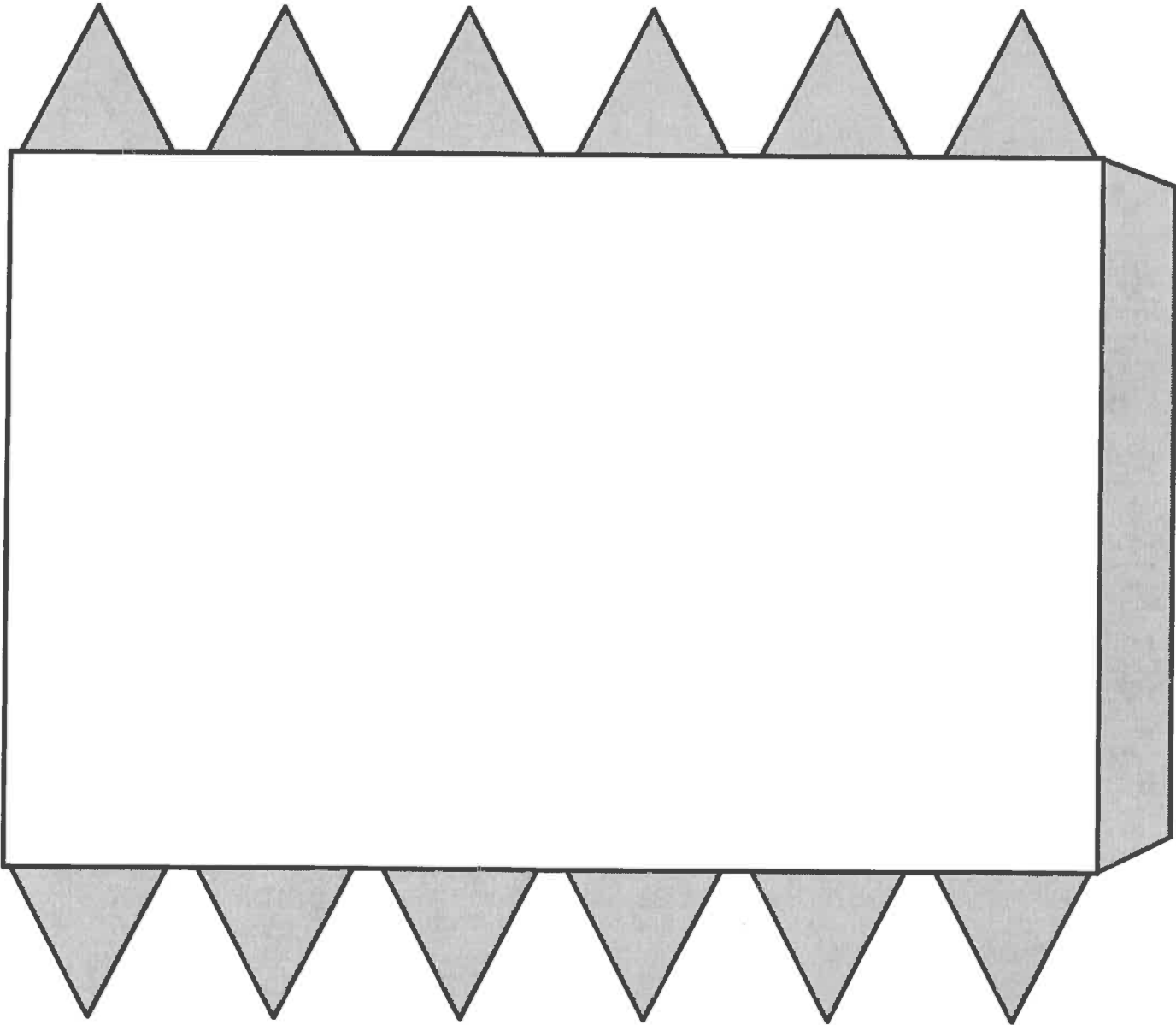

Octahedron

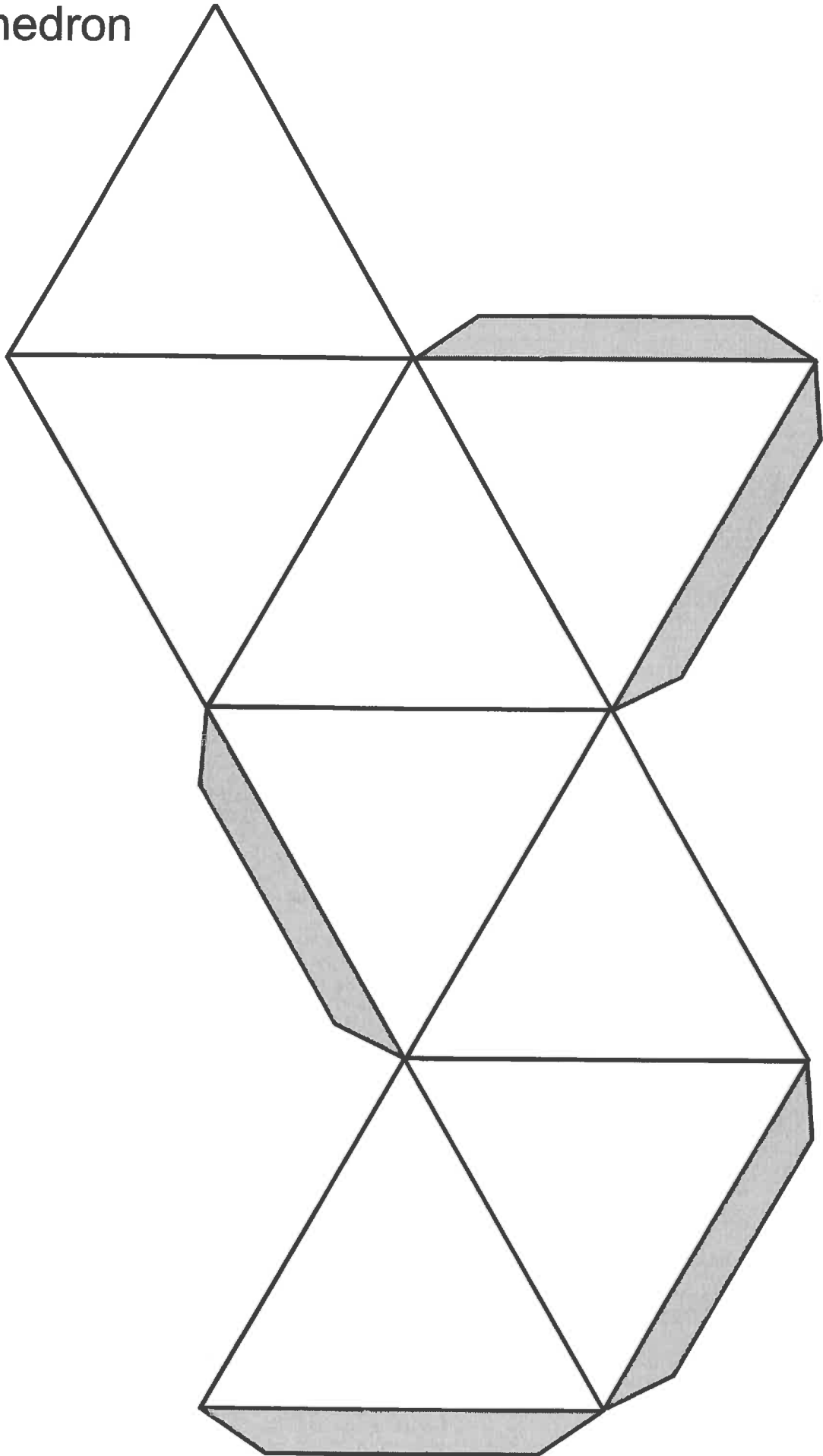

Rhombic Prism

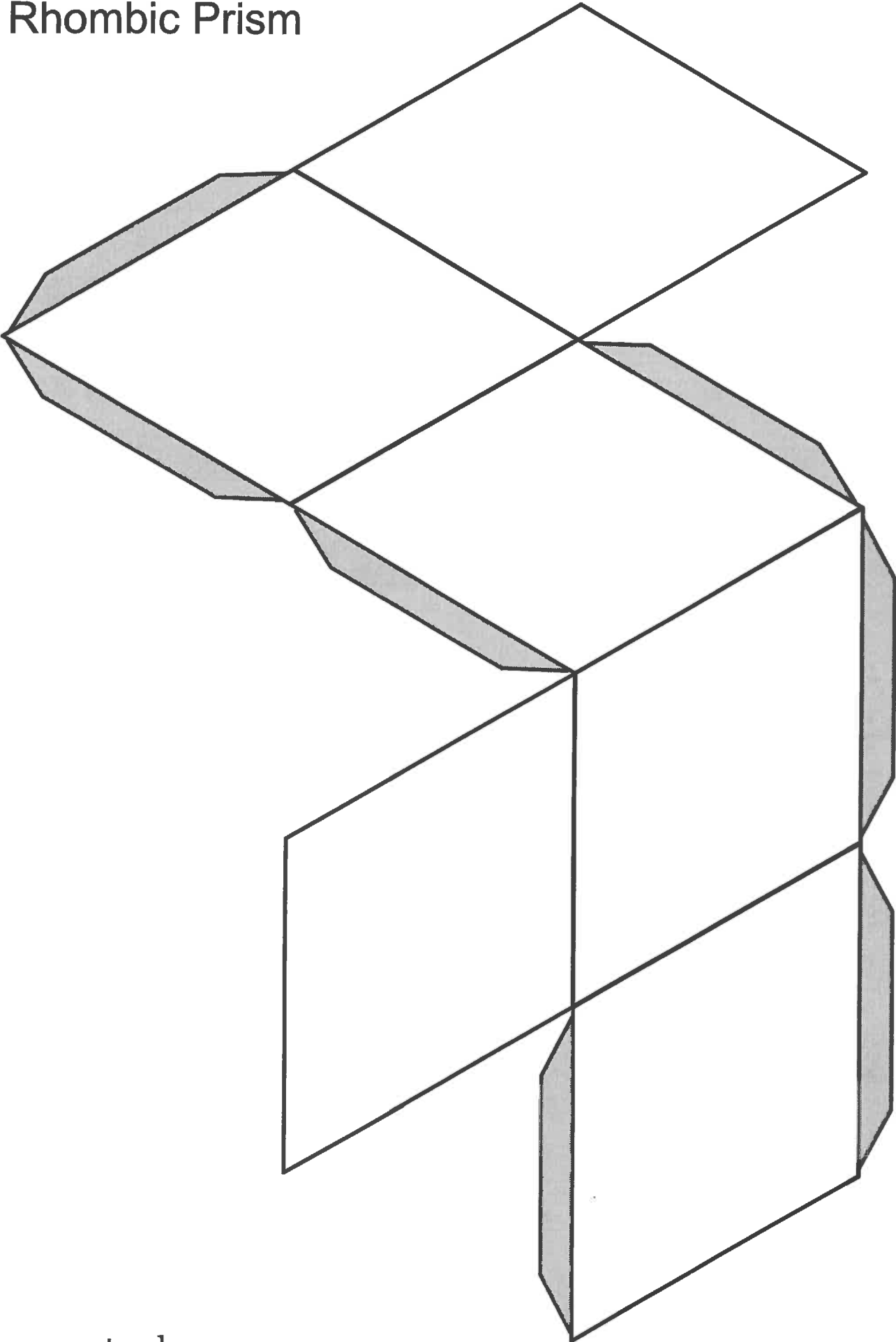

Dodecahedron

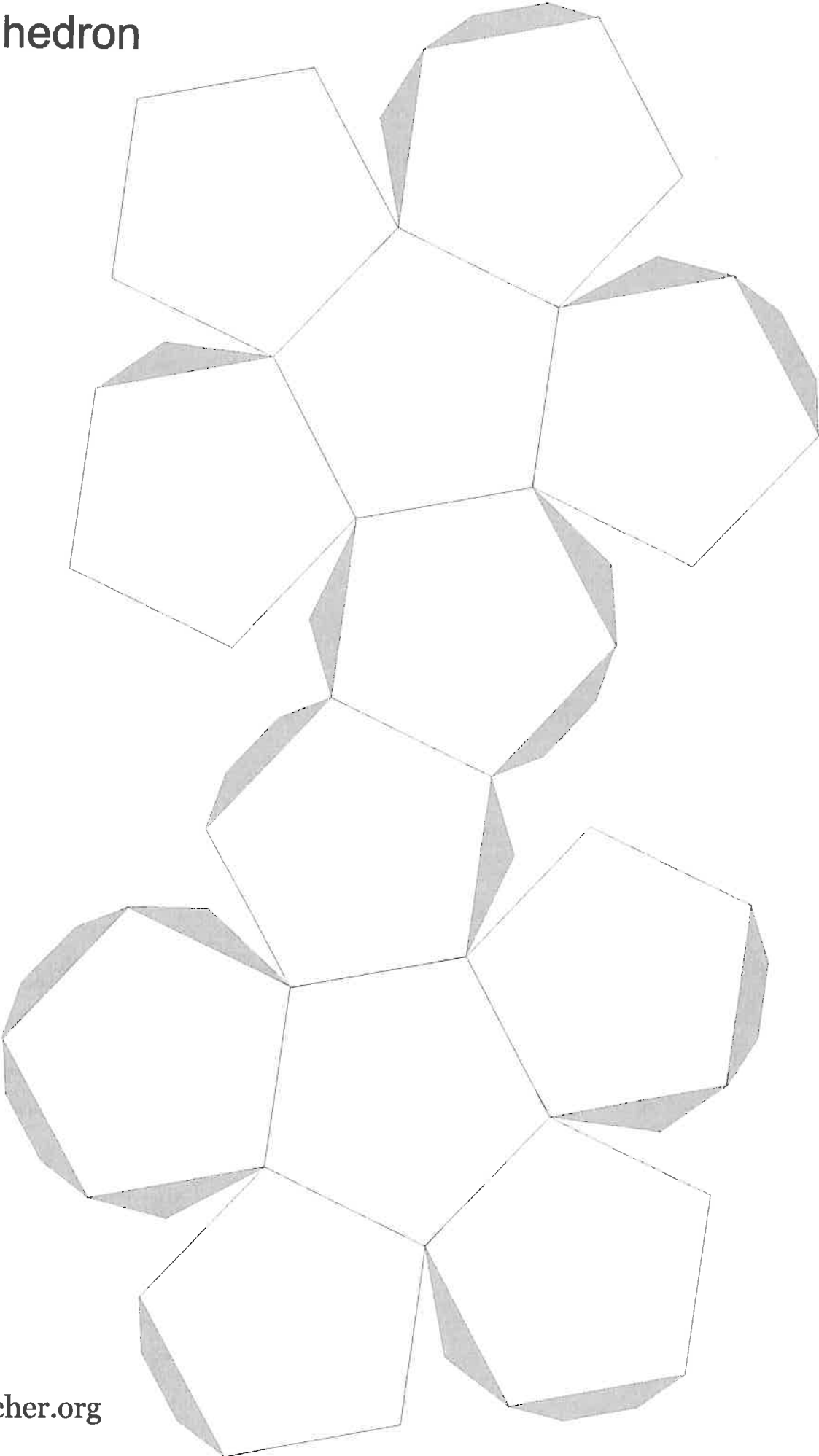

Pentagonal Prism

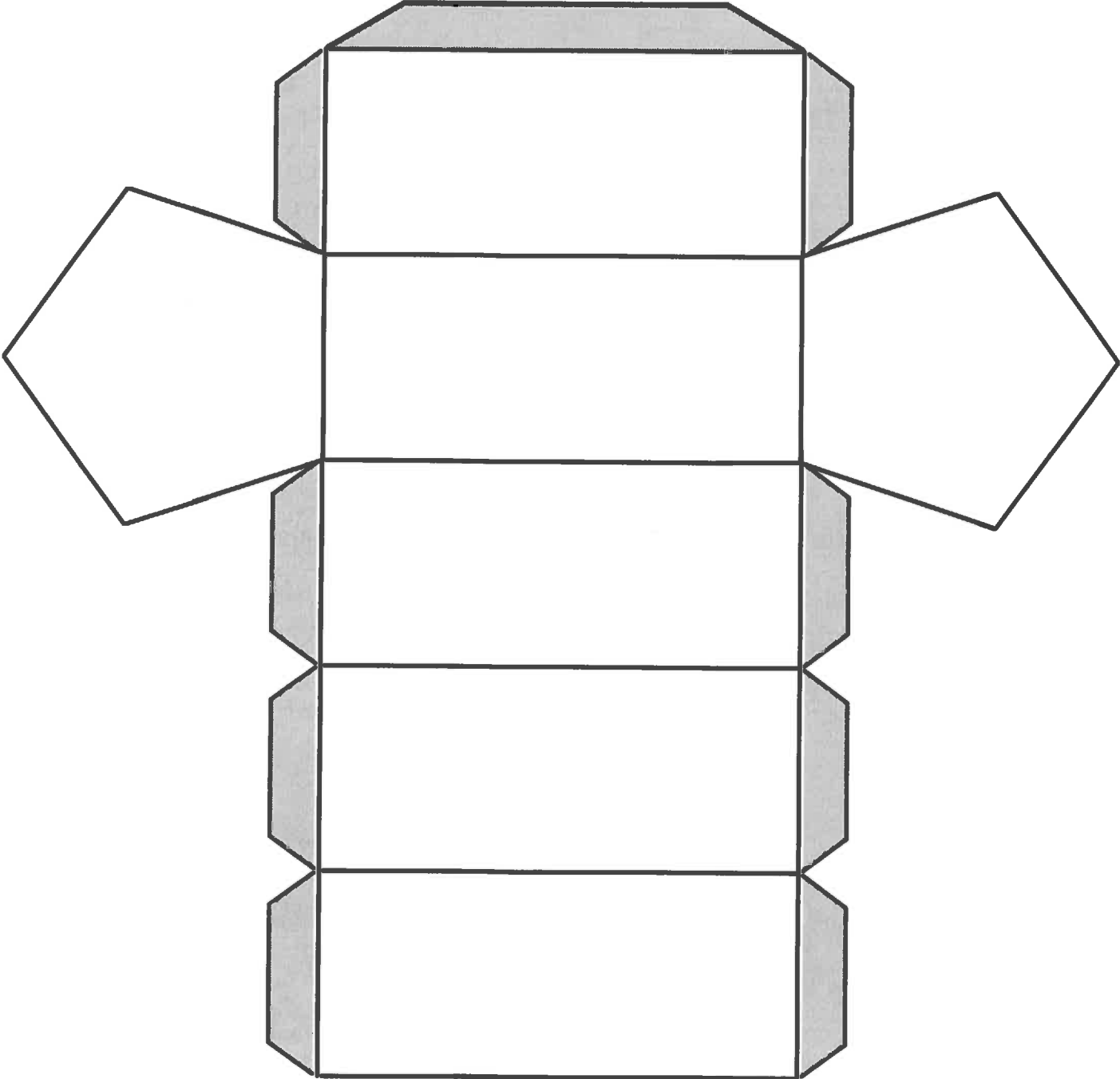

Triangular Prism

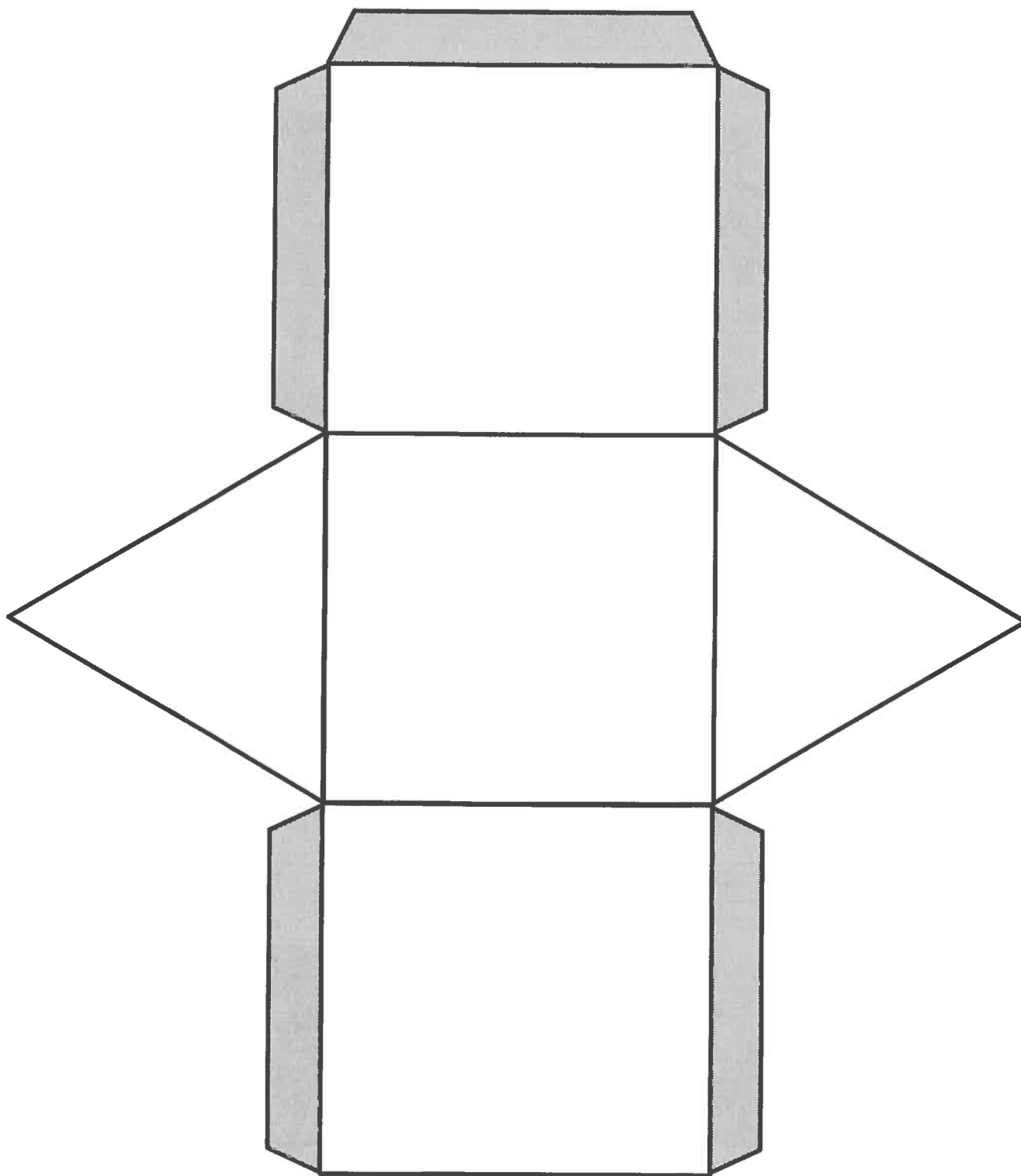

Icosahedron

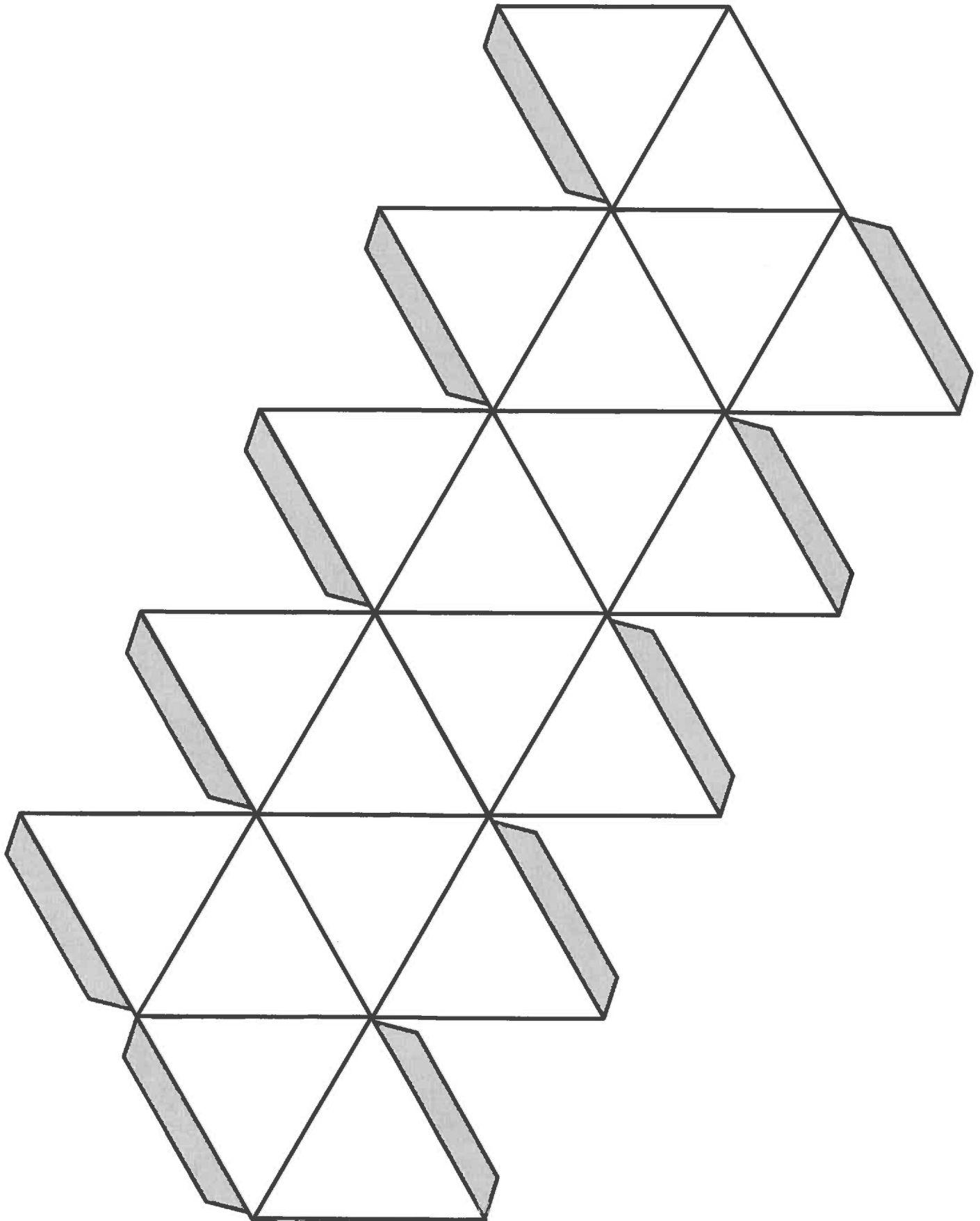

Pentagonal Pyramid

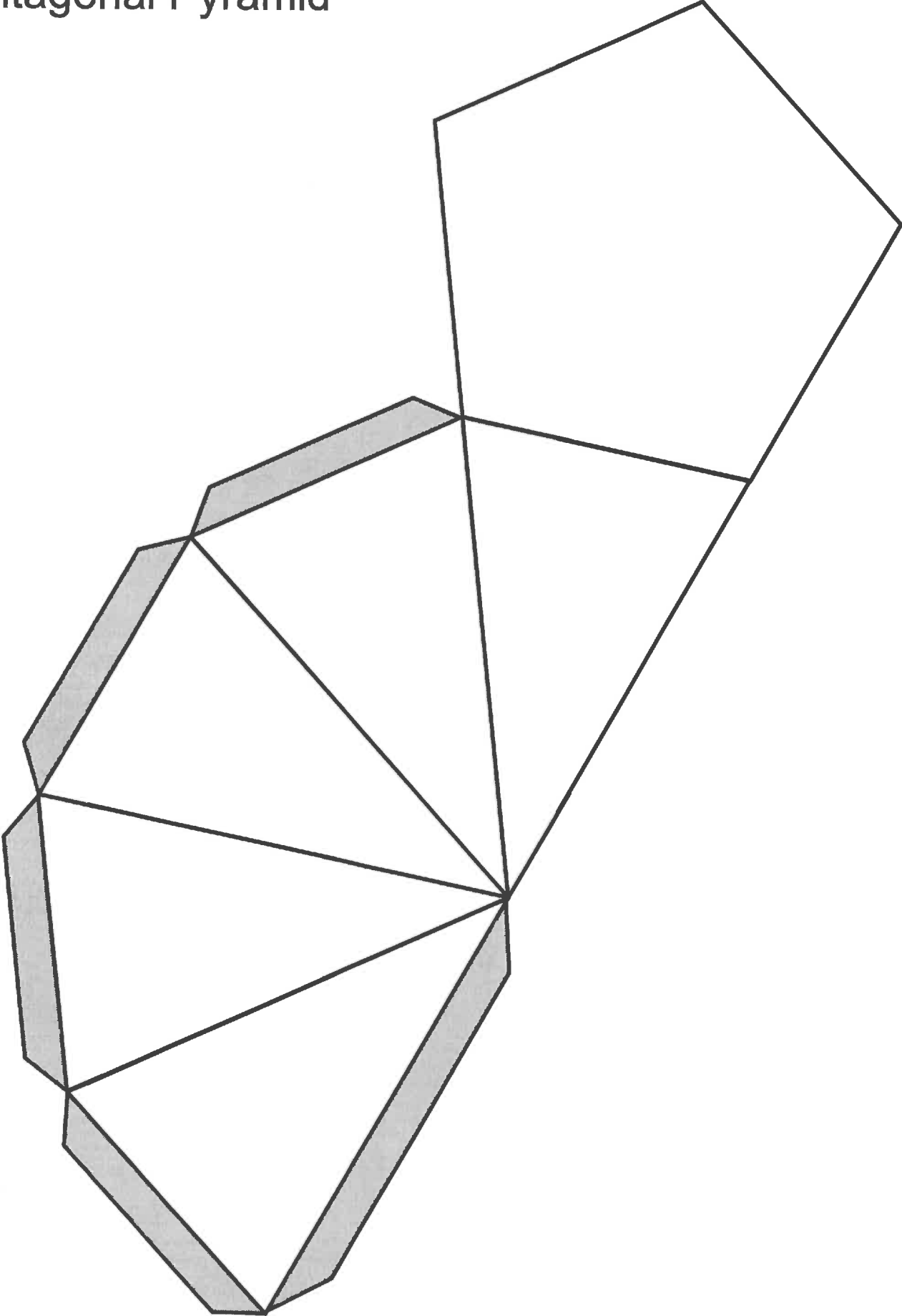

Hexagonal Pyramid

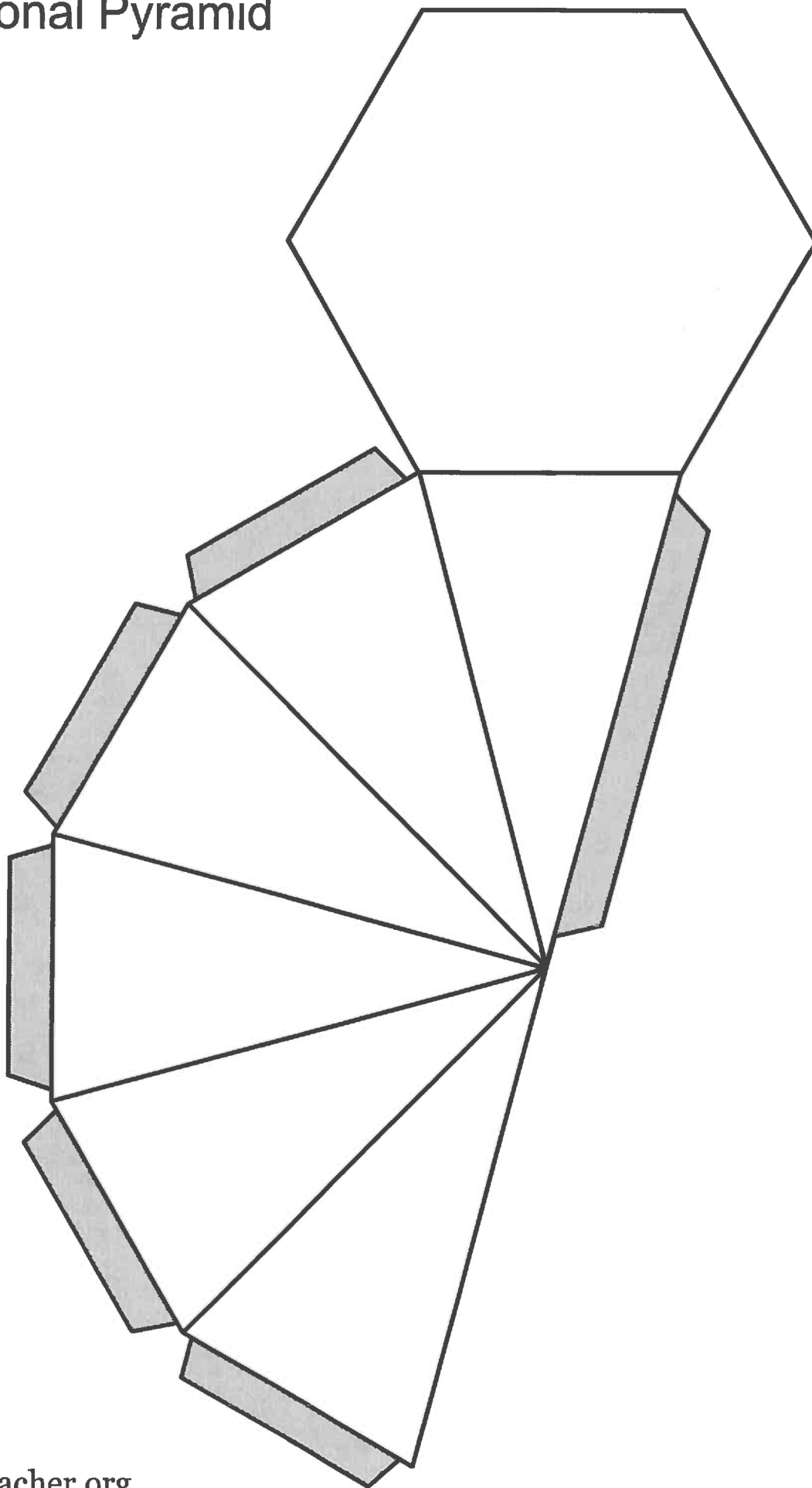

Hexagonal Prism

