

ASBESTOS MANAGEMENT PLAN



at

Kyrene De La Esperanza Elementary School

Prepared for:

Kyrene School District No. 28

**FM GROUP INC
FM Project 08-085**

April 2008

ASBESTOS MANAGEMENT PLAN

Kyrene De La Esperanza Elementary School

April 2008

FM GROUP INC

FM Project 08-085

TABLE OF CONTENTS

<u>Section</u>		<u>Page</u>
1	GENERAL INVENTORY	1-1
2	INSPECTION REPORT	2-1
3	DESIGNATED PERSON IDENTIFICATION	3-1
4	RESPONSE ACTION	4-1
5	ACCREDITATION STATEMENTS	5-1
6	REMAINING ACBM	6-1
7	O&M PROGRAM	7-1
8	INITIAL NOTIFICATIONS	8-1
9	COST ESTIMATION	9-1
10	SIGNED STATEMENT BY DESIGNATED PERSON	10-1
11	ANNUAL NOTIFICATIONS	11-1
12	ACCREDITATION STATEMENT FOR ADDITIONAL CONSULTANT	12-1

APPENDIX A: ONGOING RECORDKEEPING

SECTION 1

GENERAL INVENTORY

General Inventory
763.93(e)(1)

Date: APRIL 6, 2008

Owner: KYRENE SCHOOL DISTRICT NO. 28

Address: 8700 SOUTH KYRENE ROAD
TEMPE, ARIZONA 85284-2197

Property: KYRENE DE LA ESPERANZA ELEMENTARY SCHOOL

Address: 14841 SOUTH 41ST PLACE
PHOENIX, ARIZONA 85044

Building Name	Friable ACM	Non-Friable ACM	Assumed ACM
MAIN	N/A	X	X
PORTABLE P71/72	X	X	X
PORTABLE P73/74	X	X	X

SECTION 2

INSPECTION REPORT

INSPECTION REPORT

The information presented in the following section is an abridgment of the facilities inspection report. This report, for purposes of recordkeeping, was identified as:

Report of Findings
Comprehensive AHERA Asbestos Inspection
Kyrene De La Esperanza Elementary School

Prepared by: FM GROUP INC
Project No.: 08-085
Date: April 2008

A complete copy of this Report of Findings can be found on file with the District's Designated Person at:

Kyrene School District No. 28
8700 South Kyrene Road
Tempe, Arizona 85284-2197

REPORT OF FINDINGS
(Abridged Version)



Comprehensive AHERA Asbestos Inspection

at

Kyrene De La Esperanza Elementary School

Prepared for:

Kyrene School District No. 28

FM GROUP INC
FM Project 08-085

April 2008

TABLE OF CONTENTS

Report of Findings
Comprehensive AHERA Asbestos Inspection
Kyrene De La Esperanza Elementary School
Kyrene School District No. 28

FM GROUP Project 08-085

<u>Section</u>	<u>Page</u>
1.0 <u>SURVEY RESULTS AND RECOMMENDATIONS</u>	1
1.1 Summary	1
1.2 Identified Asbestos-Containing Materials	1
1.3 Asbestos-Containing Building Materials (Table C)	2
1.4 ACBM/Location Plans	3
1.5 Critical Situations	4
1.6 Friable Asbestos-Containing Building Materials	4
1.7 Material Assessments	4
1.8 Recommendations	4
1.9 Qualifications of the Report.....	4
2.0 <u>PROJECT INFORMATION</u>	5
2.1 Background.....	5
2.2 Description of Construction	5
2.2.1 Main Building	5
2.2.2 Portables P71/72 and P73/74.....	6
2.3 Building Materials/Systems List (Table A)	7
2.3.1 Main Building	8
2.3.2 Portable P71/72.....	83
2.3.3 Portable P72/73.....	85
2.4 AHERA Inspection Procedures and Protocols.....	87
2.4.1 Inspection Procedures and Protocols	87
2.4.2 FM GROUP INC Inspection SOP	87
2.5 Visual Inspection	87
2.6 Homogeneous Areas of Suspect Asbestos-Containing Building Materials (Table B) .	88
2.6.1 Main Building	89
2.6.2 Portable P71/72.....	92
2.6.3 Portable P72/73.....	93
2.7 Physical Assessments	94
2.8 Sample Collection	94
2.9 Material Bulk Sample Analysis	94

Appendices

Appendix A	Suspect Asbestos-Containing Material Designation and Sample Record Forms
Appendix B	Bulk-Material Sample Documents <ul style="list-style-type: none">• Chain-of-Custody• Laboratory Analysis
Appendix C	Building Inspectors' Signature Sheet
Appendix D	Personnel and Laboratory Accreditations
Appendix E	Homogeneous Material Physical Assessment Forms

1.0 SURVEY RESULTS AND RECOMMENDATIONS

1.1 Summary

At the authorization of Kyrene School District No. 28 (KSD), FM GROUP INC (FM), has conducted a Comprehensive Asbestos Hazard Emergency Response Act (AHERA)-Compliant Asbestos Inspection for the three buildings comprising the Kyrene De La Esperanza Elementary School (KDLEES) campus. This inspection was intended to provide information regarding the presence, location and condition of identified Asbestos-Containing Building Materials (ACBM) at the subject facility.

The field portion of the inspection was performed at the subject facility during the period of March 4, 2008 through March 6, 2008. A total of 144 bulk-material samples were collected from 121 suspect ACBM located within the facility. Sampling was conducted in general accordance with the protocols set forth in the Environmental Protection Agency (EPA) AHERA Regulation 40 CFR 763.86. Samples were delivered to Fiberquant Analytical Services (FAS) for analysis by the Polarized Light Microscopy (PLM) methodology.

Seventy-three building materials within the inspected facility have been assumed to be asbestos-containing. The identified ACBM were physically assessed to be non-friable and in good condition, except for duct seam tape, which was assessed to be friable and in good condition.

1.2 Identified Asbestos-Containing Building Materials

The identified ACBM within the three buildings at KDLEES are presented in tabular form (Table C) in Section 1.3. These tables are organized to show material code, general material description, material locations, laboratory analysis, friability and material quantities. Additionally, ACBM location plans that graphically identify the known extent of these materials by floor plan locations are presented in Section 1.4.

Asbestos Material-Bulk Samples Collected

<i>Building</i>	<i>No. of Samples</i>	<i>No. HA</i>	<i>No. Assumed</i>	<i>Total No. ACM</i>
Main	138	77	31	31
Portable P71/P72	3	22	21	21
Portable P73/74	3	22	21	21

1.3 Asbestos-Containing Building Materials

**TABLE C
ASBESTOS CONTAINING BUILDING MATERIALS**

**MAIN BUILDING
PORTABLE P71/72
PORTABLE P73/74**

***TABLE C HAS BEEN MOVED TO
SECTION 6 OF ASBESTOS MANAGEMENT PLAN***

1.4 ACBM/Location Plans

**MAIN BUILDING
PORTABLE P71/72
PORTABLE P73/74**

***ACBM/LOCATION PLANS HAVE BEEN MOVED TO
SECTION 6 OF ASBESTOS MANAGEMENT PLAN***

1.5 Critical Situations

Critical situations are those areas in which the condition of existing ACBM are such as they represent an immediate danger to human health and the environment. **There were NO critical situations observed in the three buildings at KDLEES during this inspection.**

1.6 Friable Asbestos-Containing Building Materials

A friable material is one that when dry can be crumbled, pulverized, or reduced to powder by hand pressure. **There were THREE friable Asbestos-Containing Miscellaneous Building Materials in the three buildings at KDLEES during this inspection.**

- **M·DST·20 – Duct Seam Tape (P71/72)**
- **M·DST·20 – Duct Seam Tape (P73/74)**

1.7 Material Assessments

Due to the fact that **TWO friable Asbestos-Containing Miscellaneous Building Materials** were identified in the three buildings at KDLEES, **TWO** formal assessments are included in this report.

1.8 Recommendations

There are ACBM that have the potential to become damaged during future Operations and Maintenance (O&M) and renovation activities. FM, therefore, recommends that a Management Plan following EPA and Occupational Safety and Health Administration (OSHA) guidelines be developed to address the in-place management of the identified ACBM. In accordance with EPA regulations, a Management Plan must be developed by an EPA Accredited Management Planner.

1.9 Qualifications of Report

FM has endeavored to investigate the existing conditions within the subject facility using that degree of care and skill ordinarily exercised under similar circumstances by asbestos consultants practicing in this, or similar localities. The information contained in this Report is relevant to the dates of FM's site work, and should not be relied on to represent conditions at a substantially later date.

This Report has been prepared on behalf of and exclusively for the use of KSD. This Report and the findings contained herein shall not, in whole or in part, be disseminated or conveyed to any other party or be used or relied upon by any other party, in whole or in part, without FM's prior written consent.

2.0 PROJECT INFORMATION

2.1 Background

KSD intends to determine if there are any ACBM associated with the three buildings at the KDLEES campus. Based on the presumed age of the subject facility, it is likely that ACBM's were included in its construction. In compliance with EPA requirements, specifically its AHERA mandated inspections (40 CFR 763.85), KSD has contracted FM to perform a Comprehensive AHERA Compliant-Asbestos Inspection of the three buildings at the subject facility.

FM was formally engaged by KSD through the acceptance of FM's correspondence for Fee Revision, dated January 16, 2008, as evidenced by the issuance of KSD Purchase Order No. 805886, dated February 8, 2008. The project was coordinated for KSD by Mr. Giacomo Musella, Facilities Supervisor.

The subject facility is located at 14841 South 41st Place, in Phoenix, Arizona and consists of three buildings. The subject facility was occupied and operational at the time of the inspection with access provided by KSD personnel. This inspection was comprehensive by design, including interior and exterior building components and exterior mechanical systems associated with the three buildings.

At the request of KSD, select identified suspect ACBM were sampled, and remaining suspect materials were assumed to be asbestos-containing. No previous asbestos inspections were available for review.

The inspection was performed during the period of March 4, 2008 through March 6, 2008, by Michael Richter and Dane Thompson, both of whom are EPA accredited Building Inspectors. Bulk-material samples were delivered to FAS for analysis by the PLM methodology. FAS is accredited under the American Industrial Hygiene Association's (AIHA) National Institute of Standards and Technology (NIST) National Voluntary Laboratory Accreditation Program (NVLAP).

Copies of Personnel and Laboratory Accreditations are presented in Appendix D. The Accreditations included are for the current calendar time period only.

2.2 Description of Construction

2.2.1 Main Building

The construction date of the Main Building is unknown. The construction appears to be consistent and uniform throughout.

The building is built with a slab on-grade foundation. Perimeter and interior load bearing walls are of concrete masonry systems and wood or metal-framed construction, and support a concrete deck system finished with asphalt prepared roofing systems.

Floor finishes observed include: carpet, ceramic mosaic tile, unfinished concrete, quarry/paver tile, vinyl composition tile and vinyl sheet flooring.

Original walls are concrete masonry systems and wood or metal-framed, gypsum wallboard systems with textured, painted finishes, glazed wall tile, fiberglass reinforced paneling or tackable wall panels. Restroom walls are finished with gypsum wallboard systems with textured, painted finishes and glazed wall tiles. Original ceilings are wood or metal-framed and support gypsum wallboard systems with textured, painted finishes and suspended ceiling systems.

Fire doors were observed to be associated with exterior entrances into the building, corridors and miscellaneous interior rooms.

Mechanical equipment for the building consists of ground and roof-mounted mechanical units. The ductwork distribution systems run above the gypsum wallboard and suspended ceiling systems and are routed into the individual rooms through ceiling or wall-mounted supply registers.

2.2.3 Portables P71/72 and P73/74

The construction date of Portables P71/72 and P73/74 is unknown. The construction appears to be consistent and uniform throughout each Portable.

The buildings are built of wood or metal-framed foundations and are believed to be supported by masonry piers. Perimeter and interior load bearing walls are of wood or metal-framed construction and support wooden truss and deck systems finished with asphalt prepared roofing systems.

Floor finishes observed include: carpet, unfinished concrete and vinyl composition tile.

Original walls are wood or metal framed, gypsum wallboard systems with textured, painted finishes, siding (metal) or tackable wall panels. Original ceilings are wood or metal-framed and support gypsum wallboard systems and suspended ceiling systems.

Fire doors were observed to be associated with exterior entrances into the buildings.

Mechanical equipment for the buildings consists of roof-mounted air handler units. The ductwork distribution systems run above the suspended ceiling systems and are routed into the individual rooms through ceiling or wall-mounted supply registers.

A detailed description of the building material systems observed in this facility is presented as Table A in Section 2.3.

2.3 Building Materials/Systems List

TABLE A
BUILDING MATERIAL SYSTEMS

MAIN BUILDING
PORTABLE P71/72
PORTABLE P73/74

JOB NAME: *Comprehensive AHERA Asbestos Inspection
Kyrene De La Esperanza Elementary School, KSD
Main Building*

JOB NO. 08-085

**TABLE A
BUILDING MATERIAL SYSTEMS**

MATERIAL DESCRIPTION	MATERIAL LOCATION	MATERIAL COMPONENT	COMPONENT LOCATION	ACM N/S
		C/W/F/O	N/E/W/S	N/S
CONCRETE MASONRY UNIT, 4"X16", GRAY, CEMENTITIOUS	CHILLER YARD	W	N, E, W, S	S
	ROOM 35	W	N, E, W	
	PATIO	W	N, E, W, S	
	COURTYARD	W	N, E, W, S	
	ART PATIO	W	N, E, W, S	
	ROOM 54	W	N, E, W, S	
	EXTERIOR	W	N, E, W, S	
CONCRETE MASONRY UNIT, 4"X16", RED, CEMENTITIOUS	CHILLER YARD	W	N, E, W, S	S
	PATIO	W	N, E, W, S	
	COURTYARD	W	N, E, W, S	
	ART PATIO	W	N, E, W, S	
	EXTERIOR	W	N, E, W, S	
CONCRETE MASONRY UNIT, 8"X16", GRAY, CEMENTITIOUS, TEXTURED	CHILLER YARD	W	N, E, W, S	S
	PATIO	W	N, E, W, S	
	COURTYARD	W	N, E, W, S	
	ART PATIO	W	N, E, W, S	
	EXTERIOR	W	N, E, W, S	
CONCRETE MASONRY UNIT, 8"X16", GRAY, CEMENTITIOUS, 8"X8" PATTERN	CHILLER YARD	W	N, E, W, S	S
	PATIO	W	N, E, W, S	
	COURTYARD	W	N, E, W, S	
	ART PATIO	W	N, E, W, S	
	EXTERIOR	W	N, E, W, S	
MORTAR, GRAY, CEMENTITIOUS, ASSOCIATED WITH CONCRETE MASONRY UNIT, 4"X16", GRAY, CEMENTITIOUS AND CONCRETE MASONRY UNIT, 4"X16", RED, CEMENTITIOUS AND CONCRETE MASONRY UNIT, 8"X16", GRAY, CEMENTITIOUS, TEXTURED AND CONCRETE MASONRY UNIT, 8"X16", GRAY, CEMENTITIOUS, 8"X8" PATTERN	CHILLER YARD	W	N, E, W, S	S

JOB NAME: *Comprehensive AHERA Asbestos Inspection
Kyrene De La Esperanza Elementary School, KSD
Main Building*

JOB NO. 08-085

MATERIAL DESCRIPTION	MATERIAL LOCATION	MATERIAL COMPONENT	COMPONENT LOCATION	ACM N/S
		C/W/F/O	N/E/W/S	N/S
	ROOM 35	W	N, E, W	
	PATIO	W	N, E, W, S	
	COURTYARD	W	N, E, W, S	
	ART PATIO	W	N, E, W, S	
	ROOM 54	W	N, E, W, S	
	EXTERIOR	W	N, E, W, S	
SEALANT (EXPANSION), GRAY, PLIABLE	CHILLER YARD	O	N, E, W, S	S
	ROOM 35	O	N, E, W	
	PATIO	O	N, E, W, S	
	COURTYARD	O	N, E, W, S	
	ART PATIO	O	N, E, W, S	
	EXTERIOR	O	N, E, W, S	
QUARRY/PAVER TILE, 8"X8", RED, SMOOTH	ROOM 35	W	N, E	S
	CORRIDOR C-04	W	W, S	
	EXTERIOR	W	N, E, W, S	
GLASS BLOCK, 8"X8", RIBBED	RECEPTION	O	W	N
	TREATMENT	O	W	
	WORK ROOM	O	N	
	ROOM 14	O	W	
	ROOM 23	O	W	
	ROOM 27	O	E	
	ROOM 32	O	E	
	ROOM 33	O	E	
	ROOM 35	O	N, E	
	ROOM 44	O	E	
	ROOM 47	O	W	
	ROOM 52	O	W	
	ROOM 53	O	W	

JOB NAME: *Comprehensive AHERA Asbestos Inspection
Kyrene De La Esperanza Elementary School, KSD
Main Building*

JOB NO. 08-085

MATERIAL DESCRIPTION	MATERIAL LOCATION	MATERIAL COMPONENT C/W/F/O	COMPONENT LOCATION N/E/W/S	ACM N/S
	CORRIDOR C-03	O	N	
	CORRIDOR C-04	O	W, S	
	CORRIDOR C-06	O	N	
	CORRIDOR C-08	O	E	
	CORRIDOR C-10	O	S	
	CORRIDOR C-11	O	S	
	CORRIDOR C-12	O	W	
	CORRIDOR C-13	O	S	
	EXTERIOR	O	N, E, W, S	
MORTAR, WHITE, CEMENTITIOUS, ASSOCIATED WITH GLASS BLOCK, 8"X8", RIBBED	RECEPTION	O	W	S
	TREATMENT	O	W	
	WORK ROOM	O	N	
	ROOM 14	O	W	
	ROOM 23	O	W	
	ROOM 27	O	E	
	ROOM 32	O	E	
	ROOM 33	O	E	
	ROOM 35	O	N, E	
	ROOM 44	O	E	
	ROOM 47	O	W	
	ROOM 52	O	W	
	ROOM 53	O	W	
	CORRIDOR C-03	O	N	
	CORRIDOR C-04	O	W, S	
	CORRIDOR C-06	O	N	
	CORRIDOR C-08	O	E	
	CORRIDOR C-10	O	S	
	CORRIDOR C-11	O	S	

JOB NAME: *Comprehensive AHERA Asbestos Inspection
Kyrene De La Esperanza Elementary School, KSD
Main Building*

JOB NO. 08-085

MATERIAL DESCRIPTION	MATERIAL LOCATION	MATERIAL COMPONENT C/W/F/O	COMPONENT LOCATION N/E/W/S	ACM N/S
	CORRIDOR C-12	O	W	
	CORRIDOR C-13	O	S	
	EXTERIOR	O	N, E, W, S	
SEALANT (DOORS, WINDOWS), WHITE, PLIABLE	RECEPTION	O	W	S
	TREATMENT	O	W	
	WORK ROOM	O	N	
	ROOM 23	O	W	
	ROOM 27	O	E	
	ROOM 35	O	N, E	
	ROOM 52	O	W	
	ROOM 53	O	W	
	CORRIDOR C-03	O	N	
	CORRIDOR C-04	O	W, S	
	CORRIDOR C-06	O	N	
	CORRIDOR C-08	O	E	
	CORRIDOR C-10	O	S	
	CORRIDOR C-11	O	S	
	CORRIDOR C-12	O	W	
	CORRIDOR C-13	O	S	
	EXTERIOR	O	N, E, W, S	
GLAZED WALL TILE, 8"X8", WHITE, SMOOTH, MULTI-COLORED, HAND PAINTED DESIGNS	EXTERIOR	W	N, E, W, S	S
GROUT, GRAY, CEMENTITIOUS, ASSOCIATED WITH GLAZED WALL TILE, 8"X8", WHITE, SMOOTH, MULTI-COLORED, HAND PAINTED DESIGNS	EXTERIOR	W	N, E, W, S	S
CONCRETE (ENTRIES), GRAY, CEMENTITIOUS	CHILLER YARD	F	*	S
	ELECTRICAL YARD	F	*	
	KITCHEN YARD	F	*	
	ART PATIO	F	*	
	EXTERIOR	F	*	

JOB NAME: *Comprehensive AHERA Asbestos Inspection
Kyrene De La Esperanza Elementary School, KSD
Main Building*

JOB NO. 08-085

MATERIAL DESCRIPTION	MATERIAL LOCATION	MATERIAL COMPONENT C/W/F/O	COMPONENT LOCATION N/E/W/S	ACM N/S
CONCRETE (FOUNDATION), GRAY, CEMENTITIOUS	RECEPTION	F	*	S
	TREATMENT	F	*	
	NURSE 1	F	*	
	NURSE RESTROOM	F	*	
	FIRE RISER	F	*	
	NURSE 2	F	*	
	WORKROOM	F	*	
	OFFICE 1	F	*	
	PHONE	F	*	
	STAFF LOUNGE	F	*	
	JANITOR OFFICE	F	*	
	ELECTRICAL 2	F	*	
	PRINCIPAL	F	*	
	PRINCIPAL CLOSET	F	*	
	ASSISTANT PRINCIPAL	F	*	
	STORAGE 1	F	*	
	ELECTRICAL 1	F	*	
	MEN'S RESTROOM	F	*	
	WOMEN'S RESTROOM	F	*	
	ROOM 12	F	*	
	ROOM 12A	F	*	
	12 RESTROOM	F	*	
	ROOM 13	F	*	
	ROOM 13A	F	*	
	13 RESTROOM	F	*	
	ROOM 14	F	*	
	14 RESTROOM	F	*	
	ROOM 15	F	*	

JOB NAME: *Comprehensive AHERA Asbestos Inspection
Kyrene De La Esperanza Elementary School, KSD
Main Building*

JOB NO. 08-085

MATERIAL DESCRIPTION	MATERIAL LOCATION	MATERIAL COMPONENT C/W/F/O	COMPONENT LOCATION N/E/W/S	ACM N/S N/S
	ROOM 16	F	*	
	ROOM 17	F	*	
	ROOM 18	F	*	
	ROOM 19	F	*	
	ROOM 20	F	*	
	POD 1	F	*	
	JANITOR 1	F	*	
	GIRL'S RESTROOM 1	F	*	
	BOY'S RESTROOM 1	F	*	
	ROOM 21	F	*	
	ROOM 22	F	*	
	ROOM 23	F	*	
	ROOM 24	F	*	
	ROOM 25	F	*	
	ROOM 26	F	*	
	ROOM 27	F	*	
	POD 2	F	*	
	ROOM 28	F	*	
	ROOM 29	F	*	
	ROOM 30	F	*	
	ROOM 31	F	*	
	ROOM 32	F	*	
	ROOM 33	F	*	
	POD 3	F	*	
	ROOM 34	F	*	
	ROOM 34A	F	*	
	JANITOR 3	F	*	
	BOY'S RESTROOM 3	F	*	

JOB NAME: *Comprehensive AHERA Asbestos Inspection
 Kyrene De La Esperanza Elementary School, KSD
 Main Building*

JOB NO. 08-085

MATERIAL DESCRIPTION	MATERIAL LOCATION	MATERIAL COMPONENT C/W/F/O	COMPONENT LOCATION N/E/W/S	ACM N/S
	GIRL'S RESTROOM 3	F	*	
	ROOM 35	F	*	
	ROOM 35A	F	*	
	ROOM 35B	F	*	
	WEST WING	F	*	
	STAGE	F	*	
	EAST WING	F	*	
	ROOM 36	F	*	
	ROOM 37	F	*	
	ROOM 37A	F	*	
	ROOM 38	F	*	
	ROOM 38A	F	*	
	ROOM 66	F	*	
	ROOM 66A	F	*	
	ROOM 67	F	*	
	ROOM 39	F	*	
	ROOM 40	F	*	
	ROOM 41	F	*	
	ROOM 41A	F	*	
	GIRL'S RESTROOM 2	F	*	
	BOY'S RESTROOM 2	F	*	
	JANITOR 2	F	*	
	ROOM 42	F	*	
	ROOM 43	F	*	
	ROOM 44	F	*	
	ROOM 45	F	*	
	ROOM 46	F	*	
	ROOM 47	F	*	

JOB NAME: *Comprehensive AHERA Asbestos Inspection
Kyrene De La Esperanza Elementary School, KSD
Main Building*

JOB NO. 08-085

MATERIAL DESCRIPTION	MATERIAL LOCATION	MATERIAL COMPONENT C/W/F/O	COMPONENT LOCATION N/E/W/S	ACM N/S N/S
	POD 4	F	*	
	ROOM 48	F	*	
	ROOM 49	F	*	
	ROOM 50	F	*	
	ROOM 51	F	*	
	ROOM 52	F	*	
	ROOM 53	F	*	
	POD 5	F	*	
	FOYER 1	F	*	
	ROOM 54	F	*	
	ROOM 55	F	*	
	ROOM 55A	F	*	
	ROOM 56	F	*	
	ROOM 56A	F	*	
	ROOM 57	F	*	
	ROOM 57A	F	*	
	ROOM 58	F	*	
	ROOM 59	F	*	
	ROOM 59A	F	*	
	ROOM 59B	F	*	
	ROOM 60	F	*	
	ROOM 61	F	*	
	ROOM 61A	F	*	
	FOYER 2	F	*	
	ROOM 62	F	*	
	ROOM 62A	F	*	
	ROOM 63	F	*	
	ROOM 63A	F	*	

JOB NAME: *Comprehensive AHERA Asbestos Inspection
Kyrene De La Esperanza Elementary School, KSD
Main Building*

JOB NO. 08-085

MATERIAL DESCRIPTION	MATERIAL LOCATION	MATERIAL COMPONENT C/W/F/O	COMPONENT LOCATION N/E/W/S	ACM N/S
	CORRIDOR C-01	F	*	
	CORRIDOR C-02	F	*	
	CORRIDOR C-03	F	*	
	CORRIDOR C-04	F	*	
	CORRIDOR C-05	F	*	
	CORRIDOR C-06	F	*	
	CORRIDOR C-07	F	*	
	CORRIDOR C-08	F	*	
	CORRIDOR C-09	F	*	
	CORRIDOR C-10	F	*	
	CORRIDOR C-11	F	*	
	CORRIDOR C-12	F	*	
	CORRIDOR C-13	F	*	
CONCRETE (EQUIPMENT PAD), GRAY, CEMENTITIOUS	CHILLER YARD	F	*	S
CONCRETE MASONRY UNIT, 8"X16", GRAY, CEMENTITIOUS, TEXTURED	EXTERIOR	W	N, E, W, S	S
CONCRETE MASONRY UNIT, 4"X16", RED, CEMENTITIOUS	EXTERIOR	W	N, E, W, S	S
MORTAR, GRAY, CEMENTITIOUS, ASSOCIATED WITH CONCRETE MASONRY UNIT, 8"X16", GRAY, CEMENTITIOUS, TEXTURED AND CONCRETE MASONRY UNIT, 4"X16", RED, CEMENTITIOUS	EXTERIOR	W	N, E, W, S	S
BUILT-UP ROOFING, BLACK, ASPHALTIC, GRAY MINERAL CAP, SILVER COATING	ROOF	O	*	S
MASTIC (PENETRATIONS AND FLASHINGS), BLACK, TAR-LIKE	ROOF	O	*	S
TROWELED-ON TEXTURE (SERVICE AREAS), WHITE, CHALKY	FIRE RISER	C, W	N, E, W, S	S
	ELECTRICAL 2	W	N, E, W, S	
	ELECTRICAL 1	W	N, E, W, S	
	ROOM 12A	C	*	
	ROOM 13A	C	*	
	JANITOR 3	C	*	
	ROOM 35A	C, W	N, E, W, S	

JOB NAME: *Comprehensive AHERA Asbestos Inspection
Kyrene De La Esperanza Elementary School, KSD
Main Building*

JOB NO. 08-085

MATERIAL DESCRIPTION	MATERIAL LOCATION	MATERIAL COMPONENT	COMPONENT LOCATION	ACM N/S
		C/W/F/O	N/E/W/S	N/S
	ROOM 63A	W	N, E, W, S	
GYPSUM WALLBOARD, WHITE, CHALKY, ASSOCIATED WITH TROWELED-ON TEXTURE (SERVICE AREAS), WHITE, CHALKY	FIRE RISER	C, W	N, E, W, S	S
	ELECTRICAL 2	W	N, E, W, S	
	ELECTRICAL 1	W	N, E, W, S	
	ROOM 12A	C	*	
	ROOM 13A	C	*	
	JANITOR 3	C	*	
	ROOM 35A	C, W	N, E, W, S	
	ROOM 63A	W	N, E, W, S	
JOINT COMPOUND, WHITE, CHALKY, ASSOCIATED WITH GYPSUM WALLBOARD, WHITE, CHALKY	FIRE RISER	C, W	N, E, W, S	S
	ELECTRICAL 2	W	N, E, W, S	
	ELECTRICAL 1	W	N, E, W, S	
	ROOM 12A	C	*	
	ROOM 13A	C	*	
	JANITOR 3	C	*	
	ROOM 35A	C, W	N, E, W, S	
	ROOM 63A	W	N, E, W, S	
VINYL COMPOSITION TILE, 12"X12", TAN, SMOOTH, TAN MOTTLES	NURSE RESTROOM	F	*	S
	FIRE RISER	F	*	
	WORK ROOM	F	*	
	STAFF LOUNGE	F	*	
	JANITOR OFFICE	F	*	
	ELECTRICAL 2	F	*	
	STORAGE 1	F	*	
	ELECTRICAL 1	F	*	
	MEN'S RESTROOM	F	*	
	WOMEN'S RESTROOM	F	*	

JOB NAME: *Comprehensive AHERA Asbestos Inspection
Kyrene De La Esperanza Elementary School, KSD
Main Building*

JOB NO. 08-085

MATERIAL DESCRIPTION	MATERIAL LOCATION	MATERIAL COMPONENT C/W/F/O	COMPONENT LOCATION N/E/W/S	ACM N/S
	ROOM 12	F	*	
	12 RESTROOM	F	*	
	ROOM 13	F	*	
	13 RESTROOM	F	*	
	ROOM 14	F	*	
	14 RESTROOM	F	*	
	ROOM 15	F	*	
	ROOM 17	F	*	
	ROOM 18	F	*	
	ROOM 20	F	*	
	POD 1	F	*	
	JANITOR 1	F	*	
	ROOM 21	F	*	
	ROOM 22	F	*	
	ROOM 23	F	*	
	ROOM 25	F	*	
	ROOM 26	F	*	
	ROOM 27	F	*	
	POD 2	F	*	
	ROOM 28	F	*	
	ROOM 29	F	*	
	ROOM 30	F	*	
	ROOM 31	F	*	
	ROOM 32	F	*	
	POD 3	F	*	
	ROOM 34	F	*	
	ROOM 34A	F	*	
	JANITOR 3	F	*	

JOB NAME: *Comprehensive AHERA Asbestos Inspection
 Kyrene De La Esperanza Elementary School, KSD
 Main Building*

JOB NO. 08-085

MATERIAL DESCRIPTION	MATERIAL LOCATION	MATERIAL COMPONENT C/W/F/O	COMPONENT LOCATION N/E/W/S	ACM N/S N/S
	ROOM 35	F	*	
	ROOM 35A	F	*	
	ROOM 35B	F	*	
	STAGE	F	*	
	ROOM 36	F	*	
	ROOM 37	F	*	
	ROOM 37A	F	*	
	ROOM 38	F	*	
	ROOM 39	F	*	
	ROOM 40	F	*	
	ROOM 41A	F	*	
	JANITOR 2	F	*	
	ROOM 42	F	*	
	ROOM 43	F	*	
	ROOM 44	F	*	
	ROOM 45	F	*	
	ROOM 46	F	*	
	ROOM 47	F	*	
	POD 4	F	*	
	ROOM 48	F	*	
	ROOM 49	F	*	
	ROOM 50	F	*	
	ROOM 51	F	*	
	ROOM 52	F	*	
	ROOM 53	F	*	
	POD 5	F	*	
	ROOM 55	F	*	
	ROOM 55A	F	*	

JOB NAME: *Comprehensive AHERA Asbestos Inspection
Kyrene De La Esperanza Elementary School, KSD
Main Building*

JOB NO. 08-085

MATERIAL DESCRIPTION	MATERIAL LOCATION	MATERIAL COMPONENT	COMPONENT LOCATION	ACM N/S
		C/W/F/O	N/E/W/S	N/S
	ROOM 58	F	*	
	ROOM 59	F	*	
	ROOM 59A	F	*	
	ROOM 60	F	*	
	ROOM 62A	F	*	
	ROOM 63A	F	*	
MASTIC, YELLOW, TACKY, ASSOCIATED WITH VINYL COMPOSITION TILE, 12"X12", TAN, SMOOTH AND VINYL COMPOSITION TILE, 12"X12", PINK, SMOOTH, TAN MOTTLES AND VINYL COMPOSITION TILE (STRIP), 2"X24", RED, SMOOTH, TAN MOTTLES AND VINYL COMPOSITION TILE (STRIP), 2"X24", BLUE, SMOOTH AND VINYL COMPOSITION TILE (STRIP), 2"X24", BLACK, SMOOTH AND VINYL COMPOSITION TILE (STRIP), 2"X24", YELLOW AND VINYL COMPOSITION TILE (STRIP), 2"X24", GREEN, SMOOTH	NURSE RESTROOM	F	*	S
	FIRE RISER	F	*	
	WORK ROOM	F	*	
	STAFF LOUNGE	F	*	
	JANITOR OFFICE	F	*	
	ELECTRICAL 2	F	*	
	STORAGE 1	F	*	
	ELECTRICAL 1	F	*	
	MEN'S RESTROOM	F	*	
	WOMEN'S RESTROOM	F	*	
	ROOM 12	F	*	
	12 RESTROOM	F	*	
	ROOM 13	F	*	
	13 RESTROOM	F	*	
	ROOM 14	F	*	
	14 RESTROOM	F	*	
	ROOM 15	F	*	

JOB NAME: *Comprehensive AHERA Asbestos Inspection
Kyrene De La Esperanza Elementary School, KSD
Main Building*

JOB NO. 08-085

MATERIAL DESCRIPTION	MATERIAL LOCATION	MATERIAL COMPONENT C/W/F/O	COMPONENT LOCATION N/E/W/S	ACM N/S N/S
	ROOM 16	F	*	
	ROOM 17	F	*	
	ROOM 18	F	*	
	ROOM 19	F	*	
	ROOM 20	F	*	
	POD 1	F	*	
	JANITOR 1	F	*	
	ROOM 21	F	*	
	ROOM 22	F	*	
	ROOM 23	F	*	
	ROOM 24	F	*	
	ROOM 25	F	*	
	ROOM 26	F	*	
	ROOM 27	F	*	
	POD 2	F	*	
	ROOM 28	F	*	
	ROOM 29	F	*	
	ROOM 30	F	*	
	ROOM 31	F	*	
	ROOM 32	F	*	
	ROOM 33	F	*	
	POD 3	F	*	
	ROOM 34	F	*	
	ROOM 34A	F	*	
	JANITOR 3	F	*	
	ROOM 35	F	*	
	ROOM 35A	F	*	
	ROOM 35B	F	*	

JOB NAME: *Comprehensive AHERA Asbestos Inspection
 Kyrene De La Esperanza Elementary School, KSD
 Main Building*

JOB NO. 08-085

MATERIAL DESCRIPTION	MATERIAL LOCATION	MATERIAL COMPONENT C/W/F/O	COMPONENT LOCATION N/E/W/S	ACM N/S N/S
	STAGE	F	*	
	ROOM 36	F	*	
	ROOM 37	F	*	
	ROOM 37A	F	*	
	ROOM 38	F	*	
	ROOM 39	F	*	
	ROOM 40	F	*	
	ROOM 41A	F	*	
	JANITOR 2	F	*	
	ROOM 42	F	*	
	ROOM 43	F	*	
	ROOM 44	F	*	
	ROOM 45	F	*	
	ROOM 46	F	*	
	ROOM 47	F	*	
	POD 4	F	*	
	ROOM 48	F	*	
	ROOM 49	F	*	
	ROOM 50	F	*	
	ROOM 51	F	*	
	ROOM 52	F	*	
	ROOM 53	F	*	
	POD 5	F	*	
	ROOM 55	F	*	
	ROOM 55A	F	*	
	ROOM 58	F	*	
	ROOM 59	F	*	
	ROOM 59A	F	*	

JOB NAME: *Comprehensive AHERA Asbestos Inspection
Kyrene De La Esperanza Elementary School, KSD
Main Building*

JOB NO. 08-085

MATERIAL DESCRIPTION	MATERIAL LOCATION	MATERIAL COMPONENT	COMPONENT LOCATION	ACM N/S
		<i>C/W/F/O</i>	<i>N/E/W/S</i>	<i>N/S</i>
	ROOM 60	F	*	
	ROOM 62A	F	*	
	ROOM 63A	F	*	
WALLBASE (COVERED), 4", BLUE, VINYL-LIKE	RECEPTION	O	N, E, W, S	S
	TREATMENT	O	N, E, W, S	
	NURSE 1	O	N, E, W, S	
	NURSE RESTROOM	O	N, E, W, S	
	FIRE RISER	O	N, E, W, S	
	NURSE 2	O	N, E, W, S	
	WORKROOM	O	N, E, W, S	
	OFFICE 1	O	N, E, W, S	
	PHONE	O	N, E, W, S	
	STAFF LOUNGE	O	N, E, W, S	
	JANITOR OFFICE	O	N, E, W, S	
	ELECTRICAL 2	O	N, E, W, S	
	PRINCIPAL	O	N, E, W, S	
	PRINCIPAL CLOSET	O	N, E, W, S	
	ASSISTANT PRINCIPAL	O	N, E, W, S	
	STORAGE 1	O	N, E, W, S	
	ELECTRICAL 1	O	N, E, W, S	
	MEN'S RESTROOM	O	N, E, W, S	
	WOMEN'S RESTROOM	O	N, E, W, S	
	ROOM 12	O	N, E, W, S	
	ROOM 12A	O	N, E, W, S	
	12 RESTROOM	O	N, E, W, S	
	ROOM 13	O	N, E, W, S	
	ROOM 13A	O	N, E, W, S	
	13 RESTROOM	O	N, E, W, S	

JOB NAME: *Comprehensive AHERA Asbestos Inspection
Kyrene De La Esperanza Elementary School, KSD
Main Building*

JOB NO. 08-085

MATERIAL DESCRIPTION	MATERIAL LOCATION	MATERIAL COMPONENT	COMPONENT LOCATION	ACM N/S
		C/W/F/O	N/E/W/S	N/S
	ROOM 14	O	N, E, W, S	
	14 RESTROOM	O	N, E, W, S	
	ROOM 15	O	N, E, W, S	
	ROOM 16	O	N, E, W, S	
	ROOM 17	O	N, E, W, S	
	ROOM 18	O	N, E, W, S	
	ROOM 19	O	N, E, W, S	
	ROOM 20	O	N, E, W, S	
	POD 1	O	N, E, W, S	
	JANITOR 1	O	N, E, W, S	
	ROOM 21	O	N, E, W, S	
	ROOM 22	O	N, E, W, S	
	ROOM 23	O	N, E, W, S	
	ROOM 24	O	N, E, W, S	
	ROOM 25	O	N, E, W, S	
	ROOM 26	O	N, E, W, S	
	ROOM 27	O	N, E, W, S	
	POD 2	O	N, E, W, S	
	ROOM 28	O	N, E, W, S	
	ROOM 29	O	N, E, W, S	
	ROOM 30	O	N, E, W, S	
	ROOM 31	O	N, E, W, S	
	ROOM 32	O	N, E, W, S	
	ROOM 33	O	N, E, W, S	
	POD 3	O	N, E, W, S	
	ROOM 34	O	N, E, W, S	
	ROOM 34A	O	N, E, W, S	
	JANITOR 3	O	N, E, W, S	

JOB NAME: *Comprehensive AHERA Asbestos Inspection
 Kyrene De La Esperanza Elementary School, KSD
 Main Building*

JOB NO. 08-085

MATERIAL DESCRIPTION	MATERIAL LOCATION	MATERIAL COMPONENT	COMPONENT LOCATION	ACM N/S
		C/W/F/O	N/E/W/S	N/S
	ROOM 35A	O	N, E, W, S	
	ROOM 35B	O	N, E, W, S	
	WEST WING	O	N, E, W, S	
	STAGE	O	N, E, W, S	
	EAST WING	O	N, E, W, S	
	ROOM 36	O	N, E, W, S	
	ROOM 37	O	N, E, W, S	
	ROOM 37A	O	N, E, W, S	
	ROOM 38	O	N, E, W, S	
	ROOM 66A	O	N, E, W, S	
	ROOM 39	O	N, E, W, S	
	ROOM 40	O	N, E, W, S	
	ROOM 41	O	N, E, W, S	
	ROOM 41A	O	N, E, W, S	
	JANITOR 2	O	N, E, W, S	
	ROOM 42	O	N, E, W, S	
	ROOM 43	O	N, E, W, S	
	ROOM 44	O	N, E, W, S	
	ROOM 45	O	N, E, W, S	
	ROOM 46	O	N, E, W, S	
	ROOM 47	O	N, E, W, S	
	POD 4	O	N, E, W, S	
	ROOM 48	O	N, E, W, S	
	ROOM 49	O	N, E, W, S	
	ROOM 50	O	N, E, W, S	
	ROOM 51	O	N, E, W, S	
	ROOM 52	O	N, E, W, S	
	ROOM 53	O	N, E, W, S	

JOB NAME: *Comprehensive AHERA Asbestos Inspection
 Kyrene De La Esperanza Elementary School, KSD
 Main Building*

JOB NO. 08-085

MATERIAL DESCRIPTION	MATERIAL LOCATION	MATERIAL COMPONENT	COMPONENT LOCATION	ACM N/S
		C/W/F/O	N/E/W/S	N/S
	POD 5	O	N, E, W, S	
	FOYER 1	O	N, E, W, S	
	ROOM 54	O	N, E, W, S	
	ROOM 55	O	N, E, W, S	
	ROOM 55A	O	N, E, W, S	
	ROOM 56	O	N, E, W, S	
	ROOM 56A	O	N, E, W, S	
	ROOM 57	O	N, E, W, S	
	ROOM 57A	O	N, E, W, S	
	ROOM 58	O	N, E, W, S	
	ROOM 59	O	N, E, W, S	
	ROOM 59A	O	N, E, W, S	
	ROOM 59B	O	N, E, W, S	
	ROOM 60	O	N, E, W, S	
	ROOM 61	O	N, E, W, S	
	ROOM 61A	O	N, E, W, S	
	FOYER 2	O	N, E, W, S	
	ROOM 62A	O	N, E, W, S	
	ROOM 63A	O	N, E, W, S	
	CORRIDOR C-01	O	N, E, W, S	
	CORRIDOR C-02	O	N, E, W, S	
	CORRIDOR C-03	O	N, E, W, S	
	CORRIDOR C-04	O	N, E, W, S	
	CORRIDOR C-05	O	N, E, W, S	
	CORRIDOR C-06	O	N, E, W, S	
	CORRIDOR C-07	O	N, E, W, S	
	CORRIDOR C-08	O	N, E, W, S	
	CORRIDOR C-09	O	N, E, W, S	

JOB NAME: *Comprehensive AHERA Asbestos Inspection
Kyrene De La Esperanza Elementary School, KSD
Main Building*

JOB NO. 08-085

MATERIAL DESCRIPTION	MATERIAL LOCATION	MATERIAL COMPONENT	COMPONENT LOCATION	ACM N/S
		C/W/F/O	N/E/W/S	N/S
	CORRIDOR C-10	O	N, E, W, S	
	CORRIDOR C-11	O	N, E, W, S	
	CORRIDOR C-12	O	N, E, W, S	
	CORRIDOR C-13	O	N, E, W, S	
ADHESIVE, CREAM, PLIABLE, ASSOCIATED WITH WALLBASE (COVERED), 4", BLUE, VINYL-LIKE	RECEPTION	O	N, E, W, S	S
	TREATMENT	O	N, E, W, S	
	NURSE 1	O	N, E, W, S	
	NURSE RESTROOM	O	N, E, W, S	
	FIRE RISER	O	N, E, W, S	
	NURSE 2	O	N, E, W, S	
	WORKROOM	O	N, E, W, S	
	OFFICE 1	O	N, E, W, S	
	PHONE	O	N, E, W, S	
	STAFF LOUNGE	O	N, E, W, S	
	JANITOR OFFICE	O	N, E, W, S	
	ELECTRICAL 2	O	N, E, W, S	
	PRINCIPAL	O	N, E, W, S	
	PRINCIPAL CLOSET	O	N, E, W, S	
	ASSISTANT PRINCIPAL	O	N, E, W, S	
	STORAGE 1	O	N, E, W, S	
	ELECTRICAL 1	O	N, E, W, S	
	MEN'S RESTROOM	O	N, E, W, S	
	WOMEN'S RESTROOM	O	N, E, W, S	
	ROOM 12	O	N, E, W, S	
	ROOM 12A	O	N, E, W, S	
	12 RESTROOM	O	N, E, W, S	
	ROOM 13	O	N, E, W, S	
	ROOM 13A	O	N, E, W, S	

JOB NAME: *Comprehensive AHERA Asbestos Inspection
Kyrene De La Esperanza Elementary School, KSD
Main Building*

JOB NO. 08-085

MATERIAL DESCRIPTION	MATERIAL LOCATION	MATERIAL COMPONENT C/W/F/O	COMPONENT LOCATION N/E/W/S	ACM N/S
	13 RESTROOM	O	N, E, W, S	
	ROOM 14	O	N, E, W, S	
	14 RESTROOM	O	N, E, W, S	
	ROOM 15	O	N, E, W, S	
	ROOM 16	O	N, E, W, S	
	ROOM 17	O	N, E, W, S	
	ROOM 18	O	N, E, W, S	
	ROOM 19	O	N, E, W, S	
	ROOM 20	O	N, E, W, S	
	POD 1	O	N, E, W, S	
	JANITOR 1	O	N, E, W, S	
	ROOM 21	O	N, E, W, S	
	ROOM 22	O	N, E, W, S	
	ROOM 23	O	N, E, W, S	
	ROOM 24	O	N, E, W, S	
	ROOM 25	O	N, E, W, S	
	ROOM 26	O	N, E, W, S	
	ROOM 27	O	N, E, W, S	
	POD 2	O	N, E, W, S	
	ROOM 28	O	N, E, W, S	
	ROOM 29	O	N, E, W, S	
	ROOM 30	O	N, E, W, S	
	ROOM 31	O	N, E, W, S	
	ROOM 32	O	N, E, W, S	
	ROOM 33	O	N, E, W, S	
	POD 3	O	N, E, W, S	
	ROOM 34	O	N, E, W, S	
	ROOM 34A	O	N, E, W, S	

JOB NAME: *Comprehensive AHERA Asbestos Inspection
Kyrene De La Esperanza Elementary School, KSD
Main Building*

JOB NO. 08-085

MATERIAL DESCRIPTION	MATERIAL LOCATION	MATERIAL COMPONENT C/W/F/O	COMPONENT LOCATION N/E/W/S	ACM N/S
	JANITOR 3	O	N, E, W, S	
	ROOM 35A	O	N, E, W, S	
	ROOM 35B	O	N, E, W, S	
	WEST WING	O	N, E, W, S	
	STAGE	O	N, E, W, S	
	EAST WING	O	N, E, W, S	
	ROOM 36	O	N, E, W, S	
	ROOM 37	O	N, E, W, S	
	ROOM 37A	O	N, E, W, S	
	ROOM 38	O	N, E, W, S	
	ROOM 66A	O	N, E, W, S	
	ROOM 39	O	N, E, W, S	
	ROOM 40	O	N, E, W, S	
	ROOM 41	O	N, E, W, S	
	ROOM 41A	O	N, E, W, S	
	JANITOR 2	O	N, E, W, S	
	ROOM 42	O	N, E, W, S	
	ROOM 43	O	N, E, W, S	
	ROOM 44	O	N, E, W, S	
	ROOM 45	O	N, E, W, S	
	ROOM 46	O	N, E, W, S	
	ROOM 47	O	N, E, W, S	
	POD 4	O	N, E, W, S	
	ROOM 48	O	N, E, W, S	
	ROOM 49	O	N, E, W, S	
	ROOM 50	O	N, E, W, S	
	ROOM 51	O	N, E, W, S	
	ROOM 52	O	N, E, W, S	

JOB NAME: *Comprehensive AHERA Asbestos Inspection
Kyrene De La Esperanza Elementary School, KSD
Main Building*

JOB NO. 08-085

MATERIAL DESCRIPTION	MATERIAL LOCATION	MATERIAL COMPONENT	COMPONENT LOCATION	ACM N/S
		C/W/F/O	N/E/W/S	N/S
	ROOM 53	O	N, E, W, S	
	POD 5	O	N, E, W, S	
	FOYER 1	O	N, E, W, S	
	ROOM 54	O	N, E, W, S	
	ROOM 55	O	N, E, W, S	
	ROOM 55A	O	N, E, W, S	
	ROOM 56	O	N, E, W, S	
	ROOM 56A	O	N, E, W, S	
	ROOM 57	O	N, E, W, S	
	ROOM 57A	O	N, E, W, S	
	ROOM 58	O	N, E, W, S	
	ROOM 59	O	N, E, W, S	
	ROOM 59A	O	N, E, W, S	
	ROOM 59B	O	N, E, W, S	
	ROOM 60	O	N, E, W, S	
	ROOM 61	O	N, E, W, S	
	ROOM 61A	O	N, E, W, S	
	FOYER 2	O	N, E, W, S	
	ROOM 62A	O	N, E, W, S	
	ROOM 63A	O	N, E, W, S	
	CORRIDOR C-01	O	N, E, W, S	
	CORRIDOR C-02	O	N, E, W, S	
	CORRIDOR C-03	O	N, E, W, S	
	CORRIDOR C-04	O	N, E, W, S	
	CORRIDOR C-05	O	N, E, W, S	
	CORRIDOR C-06	O	N, E, W, S	
	CORRIDOR C-07	O	N, E, W, S	
	CORRIDOR C-08	O	N, E, W, S	

JOB NAME: *Comprehensive AHERA Asbestos Inspection
Kyrene De La Esperanza Elementary School, KSD
Main Building*

JOB NO. 08-085

MATERIAL DESCRIPTION	MATERIAL LOCATION	MATERIAL COMPONENT	COMPONENT LOCATION	ACM N/S
		C/W/F/O	N/E/W/S	N/S
	CORRIDOR C-09	O	N, E, W, S	
	CORRIDOR C-10	O	N, E, W, S	
	CORRIDOR C-11	O	N, E, W, S	
	CORRIDOR C-12	O	N, E, W, S	
	CORRIDOR C-13	O	N, E, W, S	
FIRE DOOR INSULATION, WOOD CLADDING	RECEPTION	O	E, S	S
	FIRE RISER	O	S	
	STAFF LOUNGE	O	N, S	
	JANITOR OFFICE	O	N, S	
	PRINCIPAL	O	W	
	ASSISTANT PRINCIPAL	O	N	
	STORAGE 1	O	N	
	ELECTRICAL 1	O	E	
	MEN'S RESTROOM	O	W	
	WOMEN'S RESTROOM	O	W	
	ROOM 12	O	N	
	ROOM 13	O	E	
	ROOM 14	O	E	
	ROOM 15	O	W	
	ROOM 16	O	W	
	ROOM 17	O	W	
	ROOM 18	O	E	
	ROOM 19	O	E	
	ROOM 20	O	E	
	GIRL'S RESTROOM 1	O	W	
	BOY'S RESTROOM 1	O	W	
	ROOM 21	O	W	
	ROOM 22	O	W	

JOB NAME: *Comprehensive AHERA Asbestos Inspection
Kyrene De La Esperanza Elementary School, KSD
Main Building*

JOB NO. 08-085

MATERIAL DESCRIPTION	MATERIAL LOCATION	MATERIAL COMPONENT C/W/F/O	COMPONENT LOCATION N/E/W/S	ACM N/S N/S
	ROOM 24	O	N	
	ROOM 25	O	E	
	ROOM 26	O	E	
	ROOM 28	O	W	
	ROOM 29	O	W	
	ROOM 30	O	W	
	ROOM 31	O	N	
	ROOM 34	O	N, E, W	
	ROOM 34A	O	W	
	ROOM 35	O	N, E, W, S	
	ROOM 35A	O	S	
	ROOM 35B	O	S	
	WEST WING	O	N, S	
	STAGE	O	E	
	EAST WING	O	W	
	ROOM 36	O	W	
	ROOM 37	O	E, W	
	ROOM 38	O	N, W	
	ROOM 38A	O	S	
	KITCHEN YARD	O	W	
	ROOM 66	O	W	
	ROOM 66A	O	E, S	
	ROOM 67	O	S	
	ROOM 39	O	W	
	ROOM 40	O	W	
	ROOM 41	O	S	
	GIRL'S RESTROOM 2	O	S	
	BOY'S RESTROOM 2	O	W	

JOB NAME: *Comprehensive AHERA Asbestos Inspection
Kyrene De La Esperanza Elementary School, KSD
Main Building*

JOB NO. 08-085

<i>MATERIAL DESCRIPTION</i>	<i>MATERIAL LOCATION</i>	<i>MATERIAL COMPONENT</i>	<i>COMPONENT LOCATION</i>	<i>ACM N/S</i>
		<i>C/W/F/O</i>	<i>N/E/W/S</i>	<i>N/S</i>
	JANITOR 2	O	W	
	ROOM 42	O	E	
	ROOM 43	O	E	
	ROOM 45	O	W	
	ROOM 46	O	W	
	ROOM 48	O	E	
	ROOM 49	O	E	
	ROOM 50	O	E	
	ROOM 51	O	S	
	FOYER 1	O	E, W, S	
	ROOM 54	O	E, W	
	ROOM 55	O	E	
	ROOM 55A	O	W	
	ROOM 56	O	W, S	
	ROOM 57	O	N	
	ROOM 57A	O	S	
	ROOM 58	O	N	
	ROOM 59	O	E	
	ROOM 60	O	S	
	ROOM 61	O	N, S	
	ROOM 61A	O	S	
	FOYER 2	O	N, E, W	
	ROOM 62	O	E, W	
	ROOM 62A	O	W	
	ROOM 63	O	N, S	
	ROOM 63A	O	N	
	CORRIDOR C-01	O	N	
	CORRIDOR C-02	O	N, E, W, S	

JOB NAME: *Comprehensive AHERA Asbestos Inspection
Kyrene De La Esperanza Elementary School, KSD
Main Building*

JOB NO. 08-085

MATERIAL DESCRIPTION	MATERIAL LOCATION	MATERIAL COMPONENT C/W/F/O	COMPONENT LOCATION N/E/W/S	ACM N/S
	CORRIDOR C-03	O	E, W	
	CORRIDOR C-04	O	N, S	
	CORRIDOR C-05	O	N, E, W, S	
	CORRIDOR C-06	O	E, W	
	CORRIDOR C-07	O	E, W	
	CORRIDOR C-08	O	W, S	
	CORRIDOR C-09	O	N, E, W, S	
	CORRIDOR C-10	O	E, W	
	CORRIDOR C-11	O	E, W	
	CORRIDOR C-12	O	N, S	
	CORRIDOR C-13	O	E, W	
PIPE SEALANT, YELLOW, PLIABLE	RECEPTION	O	*	S
	TREATMENT	O	*	
	NURSE 1	O	*	
	NURSE RESTROOM	O	*	
	FIRE RISER	O	*	
	NURSE 2	O	*	
	WORKROOM	O	*	
	OFFICE 1	O	*	
	PHONE	O	*	
	STAFF LOUNGE	O	*	
	JANITOR OFFICE	O	*	
	ELECTRICAL 2	O	*	
	PRINCIPAL	O	*	
	PRINCIPAL CLOSET	O	*	
	ASSISTANT PRINCIPAL	O	*	
	STORAGE 1	O	*	
	ELECTRICAL 1	O	*	

JOB NAME: *Comprehensive AHERA Asbestos Inspection
Kyrene De La Esperanza Elementary School, KSD
Main Building*

JOB NO. 08-085

MATERIAL DESCRIPTION	MATERIAL LOCATION	MATERIAL COMPONENT C/W/F/O	COMPONENT LOCATION N/E/W/S	ACM N/S N/S
	MEN'S RESTROOM	O	*	
	WOMEN'S RESTROOM	O	*	
	ROOM 12	O	*	
	ROOM 12A	O	*	
	12 RESTROOM	O	*	
	ROOM 13	O	*	
	ROOM 13A	O	*	
	13 RESTROOM	O	*	
	ROOM 14	O	*	
	14 RESTROOM	O	*	
	ROOM 15	O	*	
	ROOM 16	O	*	
	ROOM 17	O	*	
	ROOM 18	O	*	
	ROOM 19	O	*	
	ROOM 20	O	*	
	POD 1	O	*	
	JANITOR 1	O	*	
	GIRL'S RESTROOM 1	O	*	
	BOY'S RESTROOM 1	O	*	
	CHILLER YARD	O	*	
	ROOM 21	O	*	
	ROOM 22	O	*	
	ROOM 23	O	*	
	ROOM 24	O	*	
	ROOM 25	O	*	
	ROOM 26	O	*	
	ROOM 27	O	*	

JOB NAME: *Comprehensive AHERA Asbestos Inspection
Kyrene De La Esperanza Elementary School, KSD
Main Building*

JOB NO. 08-085

MATERIAL DESCRIPTION	MATERIAL LOCATION	MATERIAL COMPONENT C/W/F/O	COMPONENT LOCATION N/E/W/S	ACM N/S N/S
	POD 2	O	*	
	ROOM 28	O	*	
	ROOM 29	O	*	
	ROOM 30	O	*	
	ROOM 31	O	*	
	ROOM 32	O	*	
	ROOM 33	O	*	
	POD 3	O	*	
	ROOM 34	O	*	
	ROOM 34A	O	*	
	JANITOR 3	O	*	
	BOY'S RESTROOM 3	O	*	
	GIRL'S RESTROOM 3	O	*	
	ROOM 35	O	*	
	ROOM 35A	O	*	
	ROOM 35B	O	*	
	WEST WING	O	*	
	STAGE	O	*	
	EAST WING	O	*	
	ROOM 36	O	*	
	ROOM 37	O	*	
	ROOM 37A	O	*	
	ROOM 38	O	*	
	ROOM 38A	O	*	
	ROOM 66	O	*	
	ROOM 66A	O	*	
	ROOM 67	O	*	
	ROOM 39	O	*	

JOB NAME: *Comprehensive AHERA Asbestos Inspection
 Kyrene De La Esperanza Elementary School, KSD
 Main Building*

JOB NO. 08-085

MATERIAL DESCRIPTION	MATERIAL LOCATION	MATERIAL COMPONENT C/W/F/O	COMPONENT LOCATION N/E/W/S	ACM N/S N/S
	ROOM 40	O	*	
	ROOM 41	O	*	
	ROOM 41A	O	*	
	GIRL'S RESTROOM 2	O	*	
	BOY'S RESTROOM 2	O	*	
	JANITOR 2	O	*	
	ROOM 42	O	*	
	ROOM 43	O	*	
	ROOM 44	O	*	
	ROOM 45	O	*	
	ROOM 46	O	*	
	ROOM 47	O	*	
	POD 4	O	*	
	ROOM 48	O	*	
	ROOM 49	O	*	
	ROOM 50	O	*	
	ROOM 51	O	*	
	ROOM 52	O	*	
	ROOM 53	O	*	
	POD 5	O	*	
	FOYER 1	O	*	
	ROOM 54	O	*	
	ROOM 55	O	*	
	ROOM 55A	O	*	
	ROOM 56	O	*	
	ROOM 56A	O	*	
	ROOM 57	O	*	
	ROOM 57A	O	*	

JOB NAME: *Comprehensive AHERA Asbestos Inspection
Kyrene De La Esperanza Elementary School, KSD
Main Building*

JOB NO. 08-085

MATERIAL DESCRIPTION	MATERIAL LOCATION	MATERIAL COMPONENT C/W/F/O	COMPONENT LOCATION N/E/W/S	ACM N/S N/S
	ROOM 58	O	*	
	ROOM 59	O	*	
	ROOM 59A	O	*	
	ROOM 59B	O	*	
	ROOM 60	O	*	
	ROOM 61	O	*	
	ROOM 61A	O	*	
	FOYER 2	O	*	
	ROOM 62	O	*	
	ROOM 62A	O	*	
	ROOM 63	O	*	
	ROOM 63A	O	*	
	CORRIDOR C-01	O	*	
	CORRIDOR C-02	O	*	
	CORRIDOR C-03	O	*	
	CORRIDOR C-04	O	*	
	CORRIDOR C-05	O	*	
	CORRIDOR C-06	O	*	
	CORRIDOR C-07	O	*	
	CORRIDOR C-08	O	*	
	CORRIDOR C-09	O	*	
	CORRIDOR C-10	O	*	
	CORRIDOR C-11	O	*	
	CORRIDOR C-12	O	*	
	CORRIDOR C-13	O	*	
SPRAY-APPLIED TEXTURE (RESTROOMS), WHITE, CHALKY	NURSE RESTROOM	C, W	N, E, W, S	S
	MEN'S RESTROOM	C, W	N, E, W, S	
	WOMEN'S RESTROOM	C, W	N, E, W, S	

JOB NAME: *Comprehensive AHERA Asbestos Inspection
Kyrene De La Esperanza Elementary School, KSD
Main Building*

JOB NO. 08-085

MATERIAL DESCRIPTION	MATERIAL LOCATION	MATERIAL COMPONENT C/W/F/O	COMPONENT LOCATION N/E/W/S	ACM N/S N/S
	12 RESTROOM	C, W	N, E, W, S	
	13 RESTROOM	C, W	N, E, W, S	
	14 RESTROOM	C, W	N, E, W, S	
	JANITOR 1	C, W	N, E, W, S	
	GIRL'S RESTROOM 1	C	*	
	BOY'S RESTROOM 1	C	*	
	JANITOR 3	C, W	N, E, W, S	
	BOY'S RESTROOM 3	C	*	
	GIRL'S RESTROOM 3	C	*	
	ROOM 37	W	N, E, W, S	
	ROOM 37A	C, W	N, E, W, S	
	ROOM 66	C	*	
	ROOM 67	C	*	
	GIRL'S RESTROOM 2	C	*	
	BOY'S RESTROOM 2	C	*	
	JANITOR 2	C, W	N, E, W, S	
	ROOM 59B	C	*	
	ROOM 62	C	*	
	ROOM 62A	W	N, E, W, S	
	ROOM 63	C	*	
GYPSUM WALLBOARD, WHITE, CHALKY, ASSOCIATED WITH SPRAY-APPLIED TEXTURE (RESTROOMS), WHITE, CHALKY	NURSE RESTROOM	C, W	N, E, W, S	S
	MEN'S RESTROOM	C, W	N, E, W, S	
	WOMEN'S RESTROOM	C, W	N, E, W, S	
	12 RESTROOM	C, W	N, E, W, S	
	13 RESTROOM	C, W	N, E, W, S	
	14 RESTROOM	C, W	N, E, W, S	
	JANITOR 1	C, W	N, E, W, S	

JOB NAME: *Comprehensive AHERA Asbestos Inspection
Kyrene De La Esperanza Elementary School, KSD
Main Building*

JOB NO. 08-085

MATERIAL DESCRIPTION	MATERIAL LOCATION	MATERIAL COMPONENT	COMPONENT LOCATION	ACM N/S
		C/W/F/O	N/E/W/S	N/S
	GIRL'S RESTROOM 1	C	*	
	BOY'S RESTROOM 1	C	*	
	JANITOR 3	C, W	N, E, W, S	
	BOY'S RESTROOM 3	C	*	
	GIRL'S RESTROOM 3	C	*	
	ROOM 37	W	N, E, W, S	
	ROOM 37A	C, W	N, E, W, S	
	ROOM 66	C	*	
	ROOM 67	C	*	
	GIRL'S RESTROOM 2	C	*	
	BOY'S RESTROOM 2	C	*	
	JANITOR 2	C, W	N, E, W, S	
	ROOM 59B	C	*	
	ROOM 62	C	*	
	ROOM 62A	W	N, E, W, S	
	ROOM 63	C	*	
JOINT COMPOUND, WHITE, CHALKY, ASSOCIATED WITH GYPSUM WALLBOARD, WHITE, CHALKY	NURSE RESTROOM	C, W	N, E, W, S	S
	MEN'S RESTROOM	C, W	N, E, W, S	
	WOMEN'S RESTROOM	C, W	N, E, W, S	
	12 RESTROOM	C, W	N, E, W, S	
	13 RESTROOM	C, W	N, E, W, S	
	14 RESTROOM	C, W	N, E, W, S	
	JANITOR 1	C, W	N, E, W, S	
	GIRL'S RESTROOM 1	C	*	
	BOY'S RESTROOM 1	C	*	
	JANITOR 3	C, W	N, E, W, S	
	BOY'S RESTROOM 3	C	*	

JOB NAME: *Comprehensive AHERA Asbestos Inspection
Kyrene De La Esperanza Elementary School, KSD
Main Building*

JOB NO. 08-085

MATERIAL DESCRIPTION	MATERIAL LOCATION	MATERIAL COMPONENT C/W/F/O	COMPONENT LOCATION N/E/W/S	ACM N/S
	GIRL'S RESTROOM 3	C	*	
	ROOM 37	W	N, E, W, S	
	ROOM 37A	C, W	N, E, W, S	
	ROOM 66	C	*	
	ROOM 67	C	*	
	GIRL'S RESTROOM 2	C	*	
	BOY'S RESTROOM 2	C	*	
	JANITOR 2	C, W	N, E, W, S	
	ROOM 59B	C	*	
	ROOM 62	C	*	
	ROOM 62A	W	N, E, W, S	
	ROOM 63	C	*	
SEALANT (DOORS, WINDOWS, MILLWORK, FIXTURES), WHITE, PLIABLE	RECEPTION	O	E, W, S	S
	TREATMENT	O	E, W	
	NURSE 1	O	W, S	
	NURSE RESTROOM	O	N, W, S	
	WORKROOM	O	N, E, S	
	OFFICE 1	O	S	
	PHONE	O	E	
	STAFF LOUNGE	O	N, E, W, S	
	JANITOR OFFICE	O	N, S	
	ELECTRICAL 2	O	N	
	PRINCIPAL	O	N, E, W	
	PRINCIPAL CLOSET	O	S	
	ASSISTANT PRINCIPAL	O	N, W	
	STORAGE 1	O	N	
	ELECTRICAL 1	O	E	
	MEN'S RESTROOM	O	E, W, S	

JOB NAME: *Comprehensive AHERA Asbestos Inspection
Kyrene De La Esperanza Elementary School, KSD
Main Building*

JOB NO. 08-085

MATERIAL DESCRIPTION	MATERIAL LOCATION	MATERIAL COMPONENT C/W/F/O	COMPONENT LOCATION N/E/W/S	ACM N/S N/S
	WOMEN'S RESTROOM	O	N, E, W, S	
	ROOM 12	O	N, E	
	ROOM 12A	O	S	
	12 RESTROOM	O	E, W	
	ROOM 13	O	E	
	ROOM 13A	O	N	
	13 RESTROOM	O	E, W	
	ROOM 14	O	E, W	
	14 RESTROOM	O	W	
	ROOM 15	O	W, S	
	ROOM 16	O	E, W, S	
	ROOM 17	O	N, W	
	ROOM 18	O	E, S	
	ROOM 19	O	E, W, S	
	ROOM 20	O	N, E	
	POD 1	O	N, E, W, S	
	JANITOR 1	O	E, W	
	GIRL'S RESTROOM 1	O	S	
	BOY'S RESTROOM 1	O	N	
	ROOM 21	O	W, S	
	ROOM 22	O	N, E, W	
	ROOM 23	O	N, W	
	ROOM 24	O	N, W	
	ROOM 25	O	E, S	
	ROOM 26	O	N, E, W	
	ROOM 27	O	N, E	
	POD 2	O	N, E, W, S	
	ROOM 28	O	W, S	

JOB NAME: *Comprehensive AHERA Asbestos Inspection
Kyrene De La Esperanza Elementary School, KSD
Main Building*

JOB NO. 08-085

MATERIAL DESCRIPTION	MATERIAL LOCATION	MATERIAL COMPONENT C/W/F/O	COMPONENT LOCATION N/E/W/S	ACM N/S N/S
	ROOM 29	O	E, W, S	
	ROOM 30	O	N, W	
	ROOM 31	O	N, S	
	ROOM 32	O	E, W, S	
	ROOM 33	O	N, E	
	POD 3	O	N, E, W, S	
	ROOM 34	O	N, E, W, S	
	ROOM 34A	O	W	
	ROOM 35	O	S	
	WEST WING	O	N, S	
	ROOM 36	O	W	
	ROOM 37	O	E, W	
	ROOM 38	O	N, W	
	ROOM 38A	O	S	
	ROOM 66	O	S	
	ROOM 66A	O	S	
	ROOM 67	O	S	
	ROOM 39	O	N, W	
	ROOM 40	O	N, W, S	
	ROOM 41	O	E, W, S	
	ROOM 41A	O	E	
	GIRL'S RESTROOM 2	O	N, S	
	BOY'S RESTROOM 2	O	E, S	
	ROOM 42	O	N, E	
	ROOM 43	O	E, W, S	
	ROOM 44	O	E, S	
	ROOM 45	O	N, W	
	ROOM 46	O	E, W, S	

JOB NAME: *Comprehensive AHERA Asbestos Inspection
Kyrene De La Esperanza Elementary School, KSD
Main Building*

JOB NO. 08-085

MATERIAL DESCRIPTION	MATERIAL LOCATION	MATERIAL COMPONENT	COMPONENT LOCATION	ACM N/S
		C/W/F/O	N/E/W/S	N/S
	ROOM 47	O	W, S	
	POD 4	O	N, E, W, S	
	ROOM 48	O	N, W	
	ROOM 49	O	N, E, W	
	ROOM 50	O	W, S	
	ROOM 51	O	N, S	
	ROOM 52	O	N, E, W	
	ROOM 53	O	W, S	
	POD 5	O	N, E, W, S	
	ROOM 54	O	E	
	ROOM 55	O	E, W	
	ROOM 55A	O	W	
	ROOM 56	O	E, W, S	
	ROOM 56A	O	W	
	ROOM 57	O	N	
	ROOM 57A	O	S	
	ROOM 58	O	N, E	
	ROOM 59	O	E, W	
	ROOM 59A	O	E	
	ROOM 59B	O	N, W	
	ROOM 60	O	E, S	
	ROOM 61	O	N, S	
	ROOM 61A	O	S	
	ROOM 62	O	E, S	
	ROOM 62A	O	W	
	ROOM 63	O	N, S	
	ROOM 63A	O	N	
	CORRIDOR C-01	O	E, W	

JOB NAME: *Comprehensive AHERA Asbestos Inspection
Kyrene De La Esperanza Elementary School, KSD
Main Building*

JOB NO. 08-085

<i>MATERIAL DESCRIPTION</i>	<i>MATERIAL LOCATION</i>	<i>MATERIAL COMPONENT</i>	<i>COMPONENT LOCATION</i>	<i>ACM N/S</i>
		<i>C/W/F/O</i>	<i>N/E/W/S</i>	<i>N/S</i>
	CORRIDOR C-02	O	N	
CARPET, GRAY, FIBROUS, MULTI-COLORED, SELF-STICK	RECEPTION	F	*	S
	TREATMENT	F	*	
	NURSE 1	F	*	
	NURSE 2	F	*	
	OFFICE 1	F	*	
	PHONE	F	*	
	STAFF LOUNGE	F	*	
	PRINCIPAL	F	*	
	PRINCIPAL CLOSET	F	*	
	ASSISTANT PRINCIPAL	F	*	
	ROOM 12	F	*	
	ROOM 13	F	*	
	ROOM 14	F	*	
	ROOM 15	F	*	
	ROOM 16	F	*	
	ROOM 17	F	*	
	ROOM 18	F	*	
	ROOM 19	F	*	
	ROOM 20	F	*	
	ROOM 21	F	*	
	ROOM 22	F	*	
	ROOM 23	F	*	
	ROOM 24	F	*	
	ROOM 25	F	*	
	ROOM 26	F	*	
	ROOM 27	F	*	
	ROOM 28	F	*	

JOB NAME: *Comprehensive AHERA Asbestos Inspection
Kyrene De La Esperanza Elementary School, KSD
Main Building*

JOB NO. 08-085

MATERIAL DESCRIPTION	MATERIAL LOCATION	MATERIAL COMPONENT C/W/F/O	COMPONENT LOCATION N/E/W/S	ACM N/S N/S
	ROOM 29	F	*	
	ROOM 30	F	*	
	ROOM 31	F	*	
	ROOM 32	F	*	
	ROOM 33	F	*	
	ROOM 34	F	*	
	ROOM 35	F	*	
	WEST WING	F	*	
	STAGE	F	*	
	EAST WING	F	*	
	ROOM 38A	F	*	
	ROOM 39	F	*	
	ROOM 41	F	*	
	ROOM 42	F	*	
	ROOM 43	F	*	
	ROOM 44	F	*	
	ROOM 45	F	*	
	ROOM 46	F	*	
	ROOM 47	F	*	
	ROOM 48	F	*	
	ROOM 49	F	*	
	ROOM 50	F	*	
	ROOM 51	F	*	
	ROOM 52	F	*	
	ROOM 53	F	*	
	FOYER 1	F	*	
	ROOM 54	F	*	
	ROOM 56	F	*	

JOB NAME: *Comprehensive AHERA Asbestos Inspection
Kyrene De La Esperanza Elementary School, KSD
Main Building*

JOB NO. 08-085

MATERIAL DESCRIPTION	MATERIAL LOCATION	MATERIAL COMPONENT C/W/F/O	COMPONENT LOCATION N/E/W/S	ACM N/S
	ROOM 56A	F	*	
	ROOM 57	F	*	
	ROOM 57A	F	*	
	ROOM 58	F	*	
	ROOM 59	F	*	
	ROOM 60	F	*	
	ROOM 61	F	*	
	ROOM 61A	F	*	
	FOYER 2	F	*	
	CORRIDOR C-02	F	*	
	CORRIDOR C-03	F	*	
	CORRIDOR C-04	F	*	
	CORRIDOR C-05	F	*	
	CORRIDOR C-06	F	*	
	CORRIDOR C-07	F	*	
	CORRIDOR C-08	F	*	
	CORRIDOR C-09	F	*	
	CORRIDOR C-10	F	*	
	CORRIDOR C-11	F	*	
	CORRIDOR C-12	F	*	
	CORRIDOR C-13	F	*	
ACOUSTICAL CEILING PANEL, 2'X2', GRAY, PINHOLES AND FISSURES, WHITE	RECEPTION	C	*	S
	TREATMENT	C	*	
	NURSE 1	C	*	
	NURSE 2	C	*	
	WORKROOM	C	*	
	OFFICE 1	C	*	
	PHONE	C	*	

JOB NAME: *Comprehensive AHERA Asbestos Inspection
Kyrene De La Esperanza Elementary School, KSD
Main Building*

JOB NO. 08-085

MATERIAL DESCRIPTION	MATERIAL LOCATION	MATERIAL COMPONENT C/W/F/O	COMPONENT LOCATION N/E/W/S	ACM N/S N/S
	STAFF LOUNGE	C	*	
	JANITOR OFFICE	C	*	
	ELECTRICAL 2	C	*	
	PRINCIPAL	C	*	
	ASSISTANT PRINCIPAL	C	*	
	STORAGE 1	C	*	
	ELECTRICAL 1	C	*	
	ROOM 12	C	*	
	ROOM 13	C	*	
	ROOM 14	C	*	
	ROOM 15	C	*	
	ROOM 16	C	*	
	ROOM 17	C	*	
	ROOM 18	C	*	
	ROOM 19	C	*	
	ROOM 20	C	*	
	POD 1	C	*	
	ROOM 21	C	*	
	ROOM 22	C	*	
	ROOM 23	C	*	
	ROOM 24	C	*	
	ROOM 25	C	*	
	ROOM 26	C	*	
	ROOM 27	C	*	
	POD 2	C	*	
	ROOM 28	C	*	
	ROOM 29	C	*	
	ROOM 30	C	*	

JOB NAME: *Comprehensive AHERA Asbestos Inspection
Kyrene De La Esperanza Elementary School, KSD
Main Building*

JOB NO. 08-085

MATERIAL DESCRIPTION	MATERIAL LOCATION	MATERIAL COMPONENT C/W/F/O	COMPONENT LOCATION N/E/W/S	ACM N/S N/S
	ROOM 31	C	*	
	ROOM 32	C	*	
	ROOM 33	C	*	
	POD 3	C	*	
	ROOM 34	C	*	
	ROOM 34A	C	*	
	ROOM 35	C	*	
	WEST WING	C	*	
	STAGE	C	*	
	EAST WING	C	*	
	ROOM 36	C	*	
	ROOM 38	C	*	
	ROOM 38A	C	*	
	ROOM 39	C	*	
	ROOM 40	C	*	
	ROOM 41	C	*	
	ROOM 42	C	*	
	ROOM 43	C	*	
	ROOM 44	C	*	
	ROOM 45	C	*	
	ROOM 46	C	*	
	ROOM 47	C	*	
	POD 4	C	*	
	ROOM 48	C	*	
	ROOM 49	C	*	
	ROOM 50	C	*	
	ROOM 51	C	*	
	ROOM 52	C	*	

JOB NAME: *Comprehensive AHERA Asbestos Inspection
Kyrene De La Esperanza Elementary School, KSD
Main Building*

JOB NO. 08-085

MATERIAL DESCRIPTION	MATERIAL LOCATION	MATERIAL COMPONENT C/W/F/O	COMPONENT LOCATION N/E/W/S	ACM N/S
	ROOM 53	C	*	
	POD 5	C	*	
	ROOM 55	C	*	
	ROOM 55A	C	*	
	ROOM 56	C	*	
	ROOM 56A	C	*	
	ROOM 57A	C	*	
	ROOM 58	C	*	
	ROOM 59	C	*	
	ROOM 60	C	*	
	ROOM 61	C	*	
	ROOM 61A	C	*	
	ROOM 63A	C	*	
	CORRIDOR C-01	C	*	
	CORRIDOR C-02	C	*	
	CORRIDOR C-03	C	*	
	CORRIDOR C-04	C	*	
	CORRIDOR C-05	C	*	
	CORRIDOR C-06	C	*	
	CORRIDOR C-07	C	*	
	CORRIDOR C-08	C	*	
	CORRIDOR C-09	C	*	
	CORRIDOR C-10	C	*	
	CORRIDOR C-11	C	*	
	CORRIDOR C-12	C	*	
	CORRIDOR C-13	C	*	
SPRAY-APPLIED TEXTURE (CLASSROOMS, OFFICES), WHITE, CHALKY	RECEPTION	W	N, E, W, S	S
	TREATMENT	W	N, E, W, S	

JOB NAME: *Comprehensive AHERA Asbestos Inspection
Kyrene De La Esperanza Elementary School, KSD
Main Building*

JOB NO. 08-085

MATERIAL DESCRIPTION	MATERIAL LOCATION	MATERIAL COMPONENT	COMPONENT LOCATION	ACM N/S
		C/W/F/O	N/E/W/S	N/S
	NURSE 1	W	N, E, W, S	
	NURSE 2	W	N, E, W, S	
	WORKROOM	W	N, E, W, S	
	OFFICE 1	W	N, E, W, S	
	PHONE	W	N, E, W, S	
	STAFF LOUNGE	W	N, E, W, S	
	JANITOR OFFICE	W	N, E, W, S	
	PRINCIPAL	W	N, E, W, S	
	PRINCIPAL CLOSET	W	N, E, W, S	
	ASSISTANT PRINCIPAL	W	N, E, W, S	
	STORAGE 1	W	N, E, W, S	
	ROOM 12	W	N, E, W, S	
	ROOM 12A	W	N, E, W, S	
	ROOM 13	W	N, E, W, S	
	ROOM 13A	W	N, E, W, S	
	ROOM 14	W	N, E, W, S	
	ROOM 15	W	N, E, W, S	
	ROOM 16	W	N, E, W, S	
	ROOM 17	W	N, E, W, S	
	ROOM 18	W	N, E, W, S	
	ROOM 19	W	N, E, W, S	
	ROOM 20	W	N, E, W, S	
	POD 1	W	N, E, W, S	
	ROOM 21	W	N, E, W, S	
	ROOM 22	W	N, E, W, S	
	ROOM 23	W	N, E, W, S	
	ROOM 24	W	N, E, W, S	
	ROOM 25	W	N, E, W, S	

JOB NAME: *Comprehensive AHERA Asbestos Inspection
Kyrene De La Esperanza Elementary School, KSD
Main Building*

JOB NO. 08-085

MATERIAL DESCRIPTION	MATERIAL LOCATION	MATERIAL COMPONENT	COMPONENT LOCATION	ACM N/S
		C/W/F/O	N/E/W/S	N/S
	ROOM 26	W	N, E, W, S	
	ROOM 27	W	N, E, W, S	
	POD 2	W	N, E, W, S	
	ROOM 28	W	N, E, W, S	
	ROOM 29	W	N, E, W, S	
	ROOM 30	W	N, E, W, S	
	ROOM 31	W	N, E, W, S	
	ROOM 32	W	N, E, W, S	
	ROOM 33	W	N, E, W, S	
	POD 3	W	N, E, W, S	
	ROOM 34	W	N, E, W, S	
	ROOM 34A	W	N, E, W, S	
	ROOM 35B	C, W	N, E, W, S	
	ROOM 36	W	N, E, W, S	
	ROOM 38	W	N, E, W, S	
	ROOM 38A	W	N, E, W, S	
	ROOM 66A	C, W	N, E, W, S	
	ROOM 39	W	N, E, W, S	
	ROOM 40	W	N, E, W, S	
	ROOM 41	W	N, E, W, S	
	ROOM 41A	C, W	N, E, W, S	
	ROOM 42	W	N, E, W, S	
	ROOM 43	W	N, E, W, S	
	ROOM 44	W	N, E, W, S	
	ROOM 45	W	N, E, W, S	
	ROOM 46	W	N, E, W, S	
	ROOM 47	W	N, E, W, S	
	POD 4	W	N, E, W, S	

JOB NAME: *Comprehensive AHERA Asbestos Inspection
Kyrene De La Esperanza Elementary School, KSD
Main Building*

JOB NO. 08-085

MATERIAL DESCRIPTION	MATERIAL LOCATION	MATERIAL COMPONENT C/W/F/O	COMPONENT LOCATION N/E/W/S	ACM N/S
	ROOM 48	W	N, E, W, S	
	ROOM 49	W	N, E, W, S	
	ROOM 50	W	N, E, W, S	
	ROOM 51	W	N, E, W, S	
	ROOM 52	W	N, E, W, S	
	ROOM 53	W	N, E, W, S	
	POD 5	W	N, E, W, S	
	ROOM 55	W	N, E, W, S	
	ROOM 55A	W	N, E, W, S	
	ROOM 56	W	N, E, W, S	
	ROOM 56A	W	N, E, W, S	
	ROOM 57	W	N, E, W, S	
	ROOM 57A	W	N, E, W, S	
	ROOM 58	W	N, E, W, S	
	ROOM 59	W	N, E, W, S	
	ROOM 59A	W	N, E, W, S	
	ROOM 59B	W	N, E, W, S	
	ROOM 60	W	N, E, W, S	
	ROOM 61	W	N, E, W, S	
	ROOM 61A	W	N, E, W, S	
GYPSUM WALLBOARD, WHITE, CHALKY, ASSOCIATED WITH SPRAY-APPLIED TEXTURE (CLASSROOMS, OFFICES), WHITE, CHALKY	RECEPTION	W	N, E, W, S	S
	TREATMENT	W	N, E, W, S	
	NURSE 1	W	N, E, W, S	
	NURSE 2	W	N, E, W, S	
	WORKROOM	W	N, E, W, S	
	OFFICE 1	W	N, E, W, S	
	PHONE	W	N, E, W, S	

JOB NAME: *Comprehensive AHERA Asbestos Inspection
Kyrene De La Esperanza Elementary School, KSD
Main Building*

JOB NO. 08-085

MATERIAL DESCRIPTION	MATERIAL LOCATION	MATERIAL COMPONENT	COMPONENT LOCATION	ACM N/S
		C/W/F/O	N/E/W/S	N/S
	STAFF LOUNGE	W	N, E, W, S	
	JANITOR OFFICE	W	N, E, W, S	
	PRINCIPAL	W	N, E, W, S	
	PRINCIPAL CLOSET	W	N, E, W, S	
	ASSISTANT PRINCIPAL	W	N, E, W, S	
	STORAGE 1	W	N, E, W, S	
	ROOM 12	W	N, E, W, S	
	ROOM 12A	W	N, E, W, S	
	ROOM 13	W	N, E, W, S	
	ROOM 13A	W	N, E, W, S	
	ROOM 14	W	N, E, W, S	
	ROOM 15	W	N, E, W, S	
	ROOM 16	W	N, E, W, S	
	ROOM 17	W	N, E, W, S	
	ROOM 18	W	N, E, W, S	
	ROOM 19	W	N, E, W, S	
	ROOM 20	W	N, E, W, S	
	POD 1	W	N, E, W, S	
	ROOM 21	W	N, E, W, S	
	ROOM 22	W	N, E, W, S	
	ROOM 23	W	N, E, W, S	
	ROOM 24	W	N, E, W, S	
	ROOM 25	W	N, E, W, S	
	ROOM 26	W	N, E, W, S	
	ROOM 27	W	N, E, W, S	
	POD 2	W	N, E, W, S	
	ROOM 28	W	N, E, W, S	
	ROOM 29	W	N, E, W, S	

JOB NAME: *Comprehensive AHERA Asbestos Inspection
Kyrene De La Esperanza Elementary School, KSD
Main Building*

JOB NO. 08-085

MATERIAL DESCRIPTION	MATERIAL LOCATION	MATERIAL COMPONENT C/W/F/O	COMPONENT LOCATION N/E/W/S	ACM N/S
	ROOM 30	W	N, E, W, S	
	ROOM 31	W	N, E, W, S	
	ROOM 32	W	N, E, W, S	
	ROOM 33	W	N, E, W, S	
	POD 3	W	N, E, W, S	
	ROOM 34	W	N, E, W, S	
	ROOM 34A	W	N, E, W, S	
	ROOM 35B	C, W	N, E, W, S	
	ROOM 36	W	N, E, W, S	
	ROOM 38	W	N, E, W, S	
	ROOM 38A	W	N, E, W, S	
	ROOM 66A	C, W	N, E, W, S	
	ROOM 39	W	N, E, W, S	
	ROOM 40	W	N, E, W, S	
	ROOM 41	W	N, E, W, S	
	ROOM 41A	C, W	N, E, W, S	
	ROOM 42	W	N, E, W, S	
	ROOM 43	W	N, E, W, S	
	ROOM 44	W	N, E, W, S	
	ROOM 45	W	N, E, W, S	
	ROOM 46	W	N, E, W, S	
	ROOM 47	W	N, E, W, S	
	POD 4	W	N, E, W, S	
	ROOM 48	W	N, E, W, S	
	ROOM 49	W	N, E, W, S	
	ROOM 50	W	N, E, W, S	
	ROOM 51	W	N, E, W, S	
	ROOM 52	W	N, E, W, S	

JOB NAME: *Comprehensive AHERA Asbestos Inspection
Kyrene De La Esperanza Elementary School, KSD
Main Building*

JOB NO. 08-085

MATERIAL DESCRIPTION	MATERIAL LOCATION	MATERIAL COMPONENT C/W/F/O	COMPONENT LOCATION N/E/W/S	ACM N/S
	ROOM 53	W	N, E, W, S	
	POD 5	W	N, E, W, S	
	ROOM 55	W	N, E, W, S	
	ROOM 55A	W	N, E, W, S	
	ROOM 56	W	N, E, W, S	
	ROOM 56A	W	N, E, W, S	
	ROOM 57	W	N, E, W, S	
	ROOM 57A	W	N, E, W, S	
	ROOM 58	W	N, E, W, S	
	ROOM 59	W	N, E, W, S	
	ROOM 59A	W	N, E, W, S	
	ROOM 59B	W	N, E, W, S	
	ROOM 60	W	N, E, W, S	
	ROOM 61	W	N, E, W, S	
	ROOM 61A	W	N, E, W, S	
JOINT COMPOUND, WHITE, CHALKY, ASSOCIATED WITH GYPSUM WALLBOARD, WHITE, CHALKY	RECEPTION	W	N, E, W, S	S
	TREATMENT	W	N, E, W, S	
	NURSE 1	W	N, E, W, S	
	NURSE 2	W	N, E, W, S	
	WORKROOM	W	N, E, W, S	
	OFFICE 1	W	N, E, W, S	
	PHONE	W	N, E, W, S	
	STAFF LOUNGE	W	N, E, W, S	
	JANITOR OFFICE	W	N, E, W, S	
	PRINCIPAL	W	N, E, W, S	
	PRINCIPAL CLOSET	W	N, E, W, S	
	ASSISTANT PRINCIPAL	W	N, E, W, S	

JOB NAME: *Comprehensive AHERA Asbestos Inspection
Kyrene De La Esperanza Elementary School, KSD
Main Building*

JOB NO. 08-085

<i>MATERIAL DESCRIPTION</i>	<i>MATERIAL LOCATION</i>	<i>MATERIAL COMPONENT C/W/F/O</i>	<i>COMPONENT LOCATION N/E/W/S</i>	<i>ACM N/S</i>
	STORAGE 1	W	N, E, W, S	
	ROOM 12	W	N, E, W, S	
	ROOM 12A	W	N, E, W, S	
	ROOM 13	W	N, E, W, S	
	ROOM 13A	W	N, E, W, S	
	ROOM 14	W	N, E, W, S	
	ROOM 15	W	N, E, W, S	
	ROOM 16	W	N, E, W, S	
	ROOM 17	W	N, E, W, S	
	ROOM 18	W	N, E, W, S	
	ROOM 19	W	N, E, W, S	
	ROOM 20	W	N, E, W, S	
	POD 1	W	N, E, W, S	
	ROOM 21	W	N, E, W, S	
	ROOM 22	W	N, E, W, S	
	ROOM 23	W	N, E, W, S	
	ROOM 24	W	N, E, W, S	
	ROOM 25	W	N, E, W, S	
	ROOM 26	W	N, E, W, S	
	ROOM 27	W	N, E, W, S	
	POD 2	W	N, E, W, S	
	ROOM 28	W	N, E, W, S	
	ROOM 29	W	N, E, W, S	
	ROOM 30	W	N, E, W, S	
	ROOM 31	W	N, E, W, S	
	ROOM 32	W	N, E, W, S	
	ROOM 33	W	N, E, W, S	
	POD 3	W	N, E, W, S	

JOB NAME: *Comprehensive AHERA Asbestos Inspection
 Kyrene De La Esperanza Elementary School, KSD
 Main Building*

JOB NO. 08-085

MATERIAL DESCRIPTION	MATERIAL LOCATION	MATERIAL COMPONENT	COMPONENT LOCATION	ACM N/S
		C/W/F/O	N/E/W/S	N/S
	ROOM 34	W	N, E, W, S	
	ROOM 34A	W	N, E, W, S	
	ROOM 35B	C, W	N, E, W, S	
	ROOM 36	W	N, E, W, S	
	ROOM 38	W	N, E, W, S	
	ROOM 38A	W	N, E, W, S	
	ROOM 66A	C, W	N, E, W, S	
	ROOM 39	W	N, E, W, S	
	ROOM 40	W	N, E, W, S	
	ROOM 41	W	N, E, W, S	
	ROOM 41A	C, W	N, E, W, S	
	ROOM 42	W	N, E, W, S	
	ROOM 43	W	N, E, W, S	
	ROOM 44	W	N, E, W, S	
	ROOM 45	W	N, E, W, S	
	ROOM 46	W	N, E, W, S	
	ROOM 47	W	N, E, W, S	
	POD 4	W	N, E, W, S	
	ROOM 48	W	N, E, W, S	
	ROOM 49	W	N, E, W, S	
	ROOM 50	W	N, E, W, S	
	ROOM 51	W	N, E, W, S	
	ROOM 52	W	N, E, W, S	
	ROOM 53	W	N, E, W, S	
	POD 5	W	N, E, W, S	
	ROOM 55	W	N, E, W, S	
	ROOM 55A	W	N, E, W, S	
	ROOM 56	W	N, E, W, S	

JOB NAME: *Comprehensive AHERA Asbestos Inspection
Kyrene De La Esperanza Elementary School, KSD
Main Building*

JOB NO. 08-085

MATERIAL DESCRIPTION	MATERIAL LOCATION	MATERIAL COMPONENT	COMPONENT LOCATION	ACM N/S
		C/W/F/O	N/E/W/S	N/S
	ROOM 56A	W	N, E, W, S	
	ROOM 57	W	N, E, W, S	
	ROOM 57A	W	N, E, W, S	
	ROOM 58	W	N, E, W, S	
	ROOM 59	W	N, E, W, S	
	ROOM 59A	W	N, E, W, S	
	ROOM 59B	W	N, E, W, S	
	ROOM 60	W	N, E, W, S	
	ROOM 61	W	N, E, W, S	
	ROOM 61A	W	N, E, W, S	
SPRAY-APPLIED TEXTURE (CORRIDORS), WHITE, CHALKY	WEST WING	W	N, E, W, S	S
	STAGE	W	N, E, W, S	
	EAST WING	W	N, E, W, S	
	FOYER 1	C, W	N, E, W, S	
	ROOM 54	C, W	N, E, W, S	
	FOYER 2	C, W	N, E, W, S	
	CORRIDOR C-01	W	N, E, W, S	
	CORRIDOR C-02	W	N, E, W, S	
	CORRIDOR C-03	C, W	N, E, W, S	
	CORRIDOR C-04	W	N, E, W, S	
	CORRIDOR C-05	C, W	N, E, W, S	
	CORRIDOR C-06	C, W	N, E, W, S	
	CORRIDOR C-07	C, W	N, E, W, S	
	CORRIDOR C-08	W	N, E, W, S	
	CORRIDOR C-09	C, W	N, E, W, S	
	CORRIDOR C-10	C, W	N, E, W, S	
	CORRIDOR C-11	C, W	N, E, W, S	
	CORRIDOR C-12	C, W	N, E, W, S	

JOB NAME: *Comprehensive AHERA Asbestos Inspection
Kyrene De La Esperanza Elementary School, KSD
Main Building*

JOB NO. 08-085

MATERIAL DESCRIPTION	MATERIAL LOCATION	MATERIAL COMPONENT	COMPONENT LOCATION	ACM N/S
	CORRIDOR C-13	C/W/F/O C, W	N/E/W/S N, E, W, S	N/S
GYPSUM WALLBOARD, WHITE, CHALKY, ASSOCIATED WITH SPRAY-APPLIED TEXTURE (CORRIDORS), WHITE, CHALKY	WEST WING	W	N, E, W, S	S
	STAGE	W	N, E, W, S	
	EAST WING	W	N, E, W, S	
	FOYER 1	C, W	N, E, W, S	
	ROOM 54	C, W	N, E, W, S	
	FOYER 2	C, W	N, E, W, S	
	CORRIDOR C-01	W	N, E, W, S	
	CORRIDOR C-02	W	N, E, W, S	
	CORRIDOR C-03	C, W	N, E, W, S	
	CORRIDOR C-04	W	N, E, W, S	
	CORRIDOR C-05	C, W	N, E, W, S	
	CORRIDOR C-06	C, W	N, E, W, S	
	CORRIDOR C-07	C, W	N, E, W, S	
	CORRIDOR C-08	W	N, E, W, S	
	CORRIDOR C-09	C, W	N, E, W, S	
	CORRIDOR C-10	C, W	N, E, W, S	
	CORRIDOR C-11	C, W	N, E, W, S	
	CORRIDOR C-12	C, W	N, E, W, S	
	CORRIDOR C-13	C, W	N, E, W, S	
JOINT COMPOUND, WHITE, CHALKY, ASSOCIATED WITH GYPSUM WALLBOARD, WHITE, CHALKY	WEST WING	W	N, E, W, S	S
	STAGE	W	N, E, W, S	
	EAST WING	W	N, E, W, S	
	FOYER 1	C, W	N, E, W, S	
	ROOM 54	C, W	N, E, W, S	
	FOYER 2	C, W	N, E, W, S	
	CORRIDOR C-01	W	N, E, W, S	

JOB NAME: *Comprehensive AHERA Asbestos Inspection
 Kyrene De La Esperanza Elementary School, KSD
 Main Building*

JOB NO. 08-085

MATERIAL DESCRIPTION	MATERIAL LOCATION	MATERIAL COMPONENT C/W/F/O	COMPONENT LOCATION N/E/W/S	ACM N/S N/S
	CORRIDOR C-02	W	N, E, W, S	
	CORRIDOR C-03	C, W	N, E, W, S	
	CORRIDOR C-04	W	N, E, W, S	
	CORRIDOR C-05	C, W	N, E, W, S	
	CORRIDOR C-06	C, W	N, E, W, S	
	CORRIDOR C-07	C, W	N, E, W, S	
	CORRIDOR C-08	W	N, E, W, S	
	CORRIDOR C-09	C, W	N, E, W, S	
	CORRIDOR C-10	C, W	N, E, W, S	
	CORRIDOR C-11	C, W	N, E, W, S	
	CORRIDOR C-12	C, W	N, E, W, S	
	CORRIDOR C-13	C, W	N, E, W, S	
SINK ACOUSTICAL COATING, GRAY, ROUGH	WORKROOM	O	W	S
	STAFF LOUNGE	O	E	
	ROOM 12	O	E	
	ROOM 13	O	E	
	ROOM 14	O	E	
	ROOM 15	O	S	
	ROOM 16	O	S	
	ROOM 17	O	N	
	ROOM 18	O	S	
	ROOM 19	O	S	
	ROOM 20	O	N	
	ROOM 21	O	S	
	ROOM 22	O	N	
	ROOM 23	O	N	
	ROOM 24	O	W	
	ROOM 25	O	S	

JOB NAME: *Comprehensive AHERA Asbestos Inspection
Kyrene De La Esperanza Elementary School, KSD
Main Building*

JOB NO. 08-085

MATERIAL DESCRIPTION	MATERIAL LOCATION	MATERIAL COMPONENT C/W/F/O	COMPONENT LOCATION N/E/W/S	ACM N/S N/S
	ROOM 26	O	N	
	ROOM 27	O	N	
	ROOM 28	O	S	
	ROOM 29	O	S	
	ROOM 30	O	N	
	ROOM 31	O	S	
	ROOM 32	O	S	
	ROOM 33	O	N	
	ROOM 34	O	W	
	ROOM 39	O	N	
	ROOM 40	O	S	
	ROOM 41	O	E	
	ROOM 42	O	N	
	ROOM 43	O	S	
	ROOM 44	O	S	
	ROOM 45	O	N	
	ROOM 46	O	S	
	ROOM 47	O	S	
	ROOM 48	O	N	
	ROOM 49	O	N	
	ROOM 50	O	S	
	ROOM 51	O	N	
	ROOM 52	O	N	
	ROOM 53	O	S	
	ROOM 54	O	E	
	ROOM 58	O	E	
	ROOM 59	O	E	
	ROOM 60	O	E	

JOB NAME: *Comprehensive AHERA Asbestos Inspection
Kyrene De La Esperanza Elementary School, KSD
Main Building*

JOB NO. 08-085

MATERIAL DESCRIPTION	MATERIAL LOCATION	MATERIAL COMPONENT C/W/F/O	COMPONENT LOCATION N/E/W/S	ACM N/S
SEALANT (DOORS, WINDOWS, MILLWORK), BLACK, GUMMY	ROOM 16	O	E	S
	ROOM 19	O	W	
	ROOM 22	O	E	
	ROOM 26	O	W	
	ROOM 29	O	E	
	ROOM 32	O	W	
	ROOM 43	O	W	
	ROOM 46	O	E	
	ROOM 49	O	W	
	FOYER 1	O	E, S	
	ROOM 56	O	W	
	CORRIDOR C-01	O	E, W	
	CORRIDOR C-03	O	E, W	
	CORRIDOR C-04	O	N	
	CORRIDOR C-05	O	N, S	
	CORRIDOR C-06	O	E, W	
	CORRIDOR C-07	O	W	
	CORRIDOR C-08	O	S	
	CORRIDOR C-09	O	N, W, S	
	CORRIDOR C-10	O	E, W	
	CORRIDOR C-11	O	E, W	
	CORRIDOR C-12	O	S	
	CORRIDOR C-13	O	E, W	
FIRE DOOR INSULATION, METAL CLADDING	RECEPTION	O	W	S
	TREATMENT	O	W	
	WORK ROOM	O	N	
	JANITOR OFFICE	O	S	
	ELECTRICAL 2	O	N	

JOB NAME: *Comprehensive AHERA Asbestos Inspection
Kyrene De La Esperanza Elementary School, KSD
Main Building*

JOB NO. 08-085

MATERIAL DESCRIPTION	MATERIAL LOCATION	MATERIAL COMPONENT	COMPONENT LOCATION	ACM N/S
		C/W/F/O	N/E/W/S	N/S
	ROOM 12	O	W	
	ROOM 12A	O	S	
	ROOM 13	O	W	
	ROOM 13A	O	N	
	ROOM 14	O	W	
	ROOM 23	O	W	
	ROOM 27	O	E	
	ROOM 32	O	E	
	ROOM 33	O	E	
	ROOM 34	O	S	
	BOY'S RESTROOM 3	O	N	
	GIRL'S RESTROOM 3	O	N	
	ROOM 35	O	N, E	
	ROOM 37	O	E	
	ROOM 37A	O	E	
	KITCHEN YARD	O	W	
	ROOM 40	O	N	
	ART PATIO	O	S	
	ROOM 44	O	E	
	ROOM 47	O	W	
	ROOM 52	O	W	
	ROOM 53	O	W	
	CORRIDOR C-03	O	N	
	CORRIDOR C-04	O	W, S	
	CORRIDOR C-06	O	N	
	CORRIDOR C-08	O	E	
	CORRIDOR C-10	O	S	
	CORRIDOR C-11	O	S	

JOB NAME: *Comprehensive AHERA Asbestos Inspection
Kyrene De La Esperanza Elementary School, KSD
Main Building*

JOB NO. 08-085

MATERIAL DESCRIPTION	MATERIAL LOCATION	MATERIAL COMPONENT C/W/F/O	COMPONENT LOCATION N/E/W/S	ACM N/S N/S
	CORRIDOR C-12	O	W	
	CORRIDOR C-13	O	S	
	EXTERIOR	O	N, E, W, S	
TACKABLE WALL PANEL, BROWN, FIBROUS, VINYL COVER	NURSE 1	W	N, E	S
	OFFICE 1	W	E	
	STAFF LOUNGE	W	N, S	
	JANITOR OFFICE	W	W	
	ROOM 12	W	N	
	ROOM 13	W	S	
	ROOM 14	W	N, W, S	
	ROOM 15	W	N	
	ROOM 16	W	W	
	ROOM 17	W	W, S	
	ROOM 18	W	N, E	
	ROOM 19	W	N, E, W	
	ROOM 20	W	E, S	
	POD 1	W	E	
	ROOM 21	W	N, W	
	ROOM 22	W	E, W	
	ROOM 23	W	S	
	ROOM 25	W	N, E	
	ROOM 26	W	E, W, S	
	ROOM 27	W	E, S	
	ROOM 28	W	N, E, W	
	ROOM 29	W	N, E, W	
	ROOM 30	W	E, W, S	
	ROOM 31	W	E, W	
	ROOM 32	W	N, W	

JOB NAME: *Comprehensive AHERA Asbestos Inspection
Kyrene De La Esperanza Elementary School, KSD
Main Building*

JOB NO. 08-085

MATERIAL DESCRIPTION	MATERIAL LOCATION	MATERIAL COMPONENT	COMPONENT LOCATION	ACM N/S
		C/W/F/O	N/E/W/S	N/S
	ROOM 33	W	W, S	
	POD 3	W	E	
	ROOM 34	W	E, S	
	ROOM 36	W	N, S	
	ROOM 37	W	E, W	
	ROOM 38A	W	N	
	ROOM 39	W	E, W, S	
	ROOM 40	W	N, E, W	
	ROOM 41	W	N, S	
	ROOM 42	W	E, S	
	ROOM 43	W	N, E, W	
	ROOM 44	W	N, W	
	ROOM 45	W	W, S	
	ROOM 46	W	N, W	
	ROOM 47	W	N, E	
	POD 4	W	E	
	ROOM 48	W	E, W, S	
	ROOM 49	W	E, W, S	
	ROOM 50	W	N, E, W	
	ROOM 51	W	E, W	
	ROOM 52	W	E, W, S	
	ROOM 53	W	N, E	
	ROOM 54	W	N, E, S	
	ROOM 56	W	N, W, S	
	ROOM 57	W	W, S	
	ROOM 58	W	N, W	
	ROOM 60	W	W, S	
	ROOM 61	W	W	

JOB NAME: *Comprehensive AHERA Asbestos Inspection
Kyrene De La Esperanza Elementary School, KSD
Main Building*

JOB NO. 08-085

MATERIAL DESCRIPTION	MATERIAL LOCATION	MATERIAL COMPONENT C/W/F/O	COMPONENT LOCATION N/E/W/S	ACM N/S
VINYL COMPOSITION TILE, 24"X24", BLUE, CIRCLE PATTERN	RECEPTION	F	*	S
	ROOM 35	F	*	
	CORRIDOR C-03	F	*	
	CORRIDOR C-04	F	*	
	CORRIDOR C-06	F	*	
	CORRIDOR C-08	F	*	
	CORRIDOR C-10	F	*	
	CORRIDOR C-11	F	*	
	CORRIDOR C-12	F	*	
	CORRIDOR C-13	F	*	
MASTIC, YELLOW, TACKY, ASSOCIATED WITH VINYL COMPOSITION TILE, 24"X24", BLUE, CIRCLE PATTERN	RECEPTION	F	*	S
	ROOM 35	F	*	
	CORRIDOR C-03	F	*	
	CORRIDOR C-04	F	*	
	CORRIDOR C-06	F	*	
	CORRIDOR C-08	F	*	
	CORRIDOR C-10	F	*	
	CORRIDOR C-11	F	*	
	CORRIDOR C-12	F	*	
	CORRIDOR C-13	F	*	
VINYL COMPOSITION TILE (PATTERN), 12"X12", PINK, SMOOTH, TAN MOTTLES	STAFF LOUNGE	F	*	S
	ROOM 12	F	*	
	ROOM 13	F	*	
	ROOM 14	F	*	
	ROOM 15	F	*	
	ROOM 16	F	*	
	ROOM 17	F	*	

JOB NAME: *Comprehensive AHERA Asbestos Inspection
Kyrene De La Esperanza Elementary School, KSD
Main Building*

JOB NO. 08-085

MATERIAL DESCRIPTION	MATERIAL LOCATION	MATERIAL COMPONENT C/W/F/O	COMPONENT LOCATION N/E/W/S	ACM N/S N/S
	ROOM 18	F	*	
	ROOM 19	F	*	
	ROOM 20	F	*	
	ROOM 21	F	*	
	ROOM 22	F	*	
	ROOM 23	F	*	
	ROOM 25	F	*	
	ROOM 26	F	*	
	ROOM 27	F	*	
	ROOM 28	F	*	
	ROOM 29	F	*	
	ROOM 30	F	*	
	ROOM 31	F	*	
	ROOM 32	F	*	
	ROOM 33	F	*	
	ROOM 34	F	*	
	ROOM 39	F	*	
	ROOM 40	F	*	
	ROOM 42	F	*	
	ROOM 43	F	*	
	ROOM 44	F	*	
	ROOM 45	F	*	
	ROOM 46	F	*	
	ROOM 47	F	*	
	ROOM 48	F	*	
	ROOM 49	F	*	
	ROOM 50	F	*	
	ROOM 51	F	*	

JOB NAME: *Comprehensive AHERA Asbestos Inspection
Kyrene De La Esperanza Elementary School, KSD
Main Building*

JOB NO. 08-085

MATERIAL DESCRIPTION	MATERIAL LOCATION	MATERIAL COMPONENT C/W/F/O	COMPONENT LOCATION N/E/W/S	ACM N/S N/S
	ROOM 52	F	*	
	ROOM 53	F	*	
SEALANT (DUCT), WHITE, PLIABLE	RECEPTION	O	*	S
	TREATMENT	O	*	
	NURSE 1	O	*	
	NURSE RESTROOM	O	*	
	FIRE RISER	O	*	
	NURSE 2	O	*	
	WORKROOM	O	*	
	OFFICE 1	O	*	
	PHONE	O	*	
	STAFF LOUNGE	O	*	
	JANITOR OFFICE	O	*	
	ELECTRICAL 2	O	*	
	PRINCIPAL	O	*	
	PRINCIPAL CLOSET	O	*	
	ASSISTANT PRINCIPAL	O	*	
	STORAGE 1	O	*	
	ELECTRICAL 1	O	*	
	MEN'S RESTROOM	O	*	
	WOMEN'S RESTROOM	O	*	
	ROOM 12	O	*	
	ROOM 12A	O	*	
	12 RESTROOM	O	*	
	ROOM 13	O	*	
	ROOM 13A	O	*	
	13 RESTROOM	O	*	
	ROOM 14	O	*	

JOB NAME: *Comprehensive AHERA Asbestos Inspection
Kyrene De La Esperanza Elementary School, KSD
Main Building*

JOB NO. 08-085

MATERIAL DESCRIPTION	MATERIAL LOCATION	MATERIAL COMPONENT	COMPONENT LOCATION	ACM N/S
		C/W/F/O	N/E/W/S	N/S
	14 RESTROOM	O	*	
	ROOM 15	O	*	
	ROOM 16	O	*	
	ROOM 17	O	*	
	ROOM 18	O	*	
	ROOM 19	O	*	
	ROOM 20	O	*	
	POD 1	O	*	
	JANITOR 1	O	*	
	GIRL'S RESTROOM 1	O	*	
	BOY'S RESTROOM 1	O	*	
	CHILLER YARD	O	*	
	ROOM 21	O	*	
	ROOM 22	O	*	
	ROOM 23	O	*	
	ROOM 24	O	*	
	ROOM 25	O	*	
	ROOM 26	O	*	
	ROOM 27	O	*	
	POD 2	O	*	
	ROOM 28	O	*	
	ROOM 29	O	*	
	ROOM 30	O	*	
	ROOM 31	O	*	
	ROOM 32	O	*	
	ROOM 33	O	*	
	POD 3	O	*	
	ROOM 34	O	*	

JOB NAME: *Comprehensive AHERA Asbestos Inspection
Kyrene De La Esperanza Elementary School, KSD
Main Building*

JOB NO. 08-085

MATERIAL DESCRIPTION	MATERIAL LOCATION	MATERIAL COMPONENT	COMPONENT LOCATION	ACM N/S
		C/W/F/O	N/E/W/S	N/S
	ROOM 34A	O	*	
	BOY'S RESTROOM 3	O	*	
	GIRL'S RESTROOM 3	O	*	
	JANITOR 3	O	*	
	ROOM 35	O	*	
	ROOM 35A	O	*	
	ROOM 35B	O	*	
	WEST WING	O	*	
	STAGE	O	*	
	EAST WING	O	*	
	ROOM 36	O	*	
	ROOM 37	O	*	
	ROOM 38	O	*	
	ROOM 38A	O	*	
	ROOM 66	O	*	
	ROOM 66A	O	*	
	ROOM 67	O	*	
	ROOM 39	O	*	
	ROOM 40	O	*	
	ROOM 41	O	*	
	ROOM 41A	O	*	
	GIRL'S RESTROOM 2	O	*	
	BOY'S RESTROOM 2	O	*	
	JANITOR 2	O	*	
	ROOM 42	O	*	
	ROOM 43	O	*	
	ROOM 44	O	*	
	ROOM 45	O	*	

JOB NAME: *Comprehensive AHERA Asbestos Inspection
 Kyrene De La Esperanza Elementary School, KSD
 Main Building*

JOB NO. 08-085

MATERIAL DESCRIPTION	MATERIAL LOCATION	MATERIAL COMPONENT C/W/F/O	COMPONENT LOCATION N/E/W/S	ACM N/S N/S
	ROOM 46	O	*	
	ROOM 47	O	*	
	POD 4	O	*	
	ROOM 48	O	*	
	ROOM 49	O	*	
	ROOM 50	O	*	
	ROOM 51	O	*	
	ROOM 52	O	*	
	ROOM 53	O	*	
	POD 5	O	*	
	FOYER 1	O	*	
	ROOM 54	O	*	
	ROOM 55	O	*	
	ROOM 55A	O	*	
	ROOM 56	O	*	
	ROOM 56A	O	*	
	ROOM 57	O	*	
	ROOM 57A	O	*	
	ROOM 58	O	*	
	ROOM 59	O	*	
	ROOM 59A	O	*	
	ROOM 59B	O	*	
	ROOM 60	O	*	
	ROOM 61	O	*	
	ROOM 61A	O	*	
	FOYER 2	O	*	
	ROOM 62	O	*	
	ROOM 62A	O	*	

JOB NAME: *Comprehensive AHERA Asbestos Inspection
Kyrene De La Esperanza Elementary School, KSD
Main Building*

JOB NO. 08-085

MATERIAL DESCRIPTION	MATERIAL LOCATION	MATERIAL COMPONENT C/W/F/O	COMPONENT LOCATION N/E/W/S	ACM N/S N/S
	ROOM 63	O	*	
	ROOM 63A	O	*	
	CORRIDOR C-01	O	*	
	CORRIDOR C-02	O	*	
	CORRIDOR C-03	O	*	
	CORRIDOR C-04	O	*	
	CORRIDOR C-05	O	*	
	CORRIDOR C-06	O	*	
	CORRIDOR C-07	O	*	
	CORRIDOR C-08	O	*	
	CORRIDOR C-09	O	*	
	CORRIDOR C-10	O	*	
	CORRIDOR C-11	O	*	
	CORRIDOR C-12	O	*	
	CORRIDOR C-13	O	*	
DUCT SEAM TAPE, 4", WHITE, CANVAS-LIKE	RECEPTION	O	*	S
	TREATMENT	O	*	
	NURSE 1	O	*	
	NURSE RESTROOM	O	*	
	FIRE RISER	O	*	
	NURSE 2	O	*	
	WORKROOM	O	*	
	OFFICE 1	O	*	
	PHONE	O	*	
	STAFF LOUNGE	O	*	
	JANITOR OFFICE	O	*	
	ELECTRICAL 2	O	*	
	PRINCIPAL	O	*	

JOB NAME: *Comprehensive AHERA Asbestos Inspection
Kyrene De La Esperanza Elementary School, KSD
Main Building*

JOB NO. 08-085

MATERIAL DESCRIPTION	MATERIAL LOCATION	MATERIAL COMPONENT	COMPONENT LOCATION	ACM N/S
		C/W/F/O	N/E/W/S	N/S
	PRINCIPAL CLOSET	O	*	
	ASSISTANT PRINCIPAL	O	*	
	STORAGE 1	O	*	
	ELECTRICAL 1	O	*	
	MEN'S RESTROOM	O	*	
	WOMEN'S RESTROOM	O	*	
	ROOM 12	O	*	
	ROOM 12A	O	*	
	12 RESTROOM	O	*	
	ROOM 13	O	*	
	ROOM 13A	O	*	
	13 RESTROOM	O	*	
	ROOM 14	O	*	
	14 RESTROOM	O	*	
	ROOM 15	O	*	
	ROOM 16	O	*	
	ROOM 17	O	*	
	ROOM 18	O	*	
	ROOM 19	O	*	
	ROOM 20	O	*	
	POD 1	O	*	
	JANITOR 1	O	*	
	GIRL'S RESTROOM 1	O	*	
	BOY'S RESTROOM 1	O	*	
	CHILLER YARD	O	*	
	ROOM 21	O	*	
	ROOM 22	O	*	
	ROOM 23	O	*	

JOB NAME: *Comprehensive AHERA Asbestos Inspection
Kyrene De La Esperanza Elementary School, KSD
Main Building*

JOB NO. 08-085

MATERIAL DESCRIPTION	MATERIAL LOCATION	MATERIAL COMPONENT C/W/F/O	COMPONENT LOCATION N/E/W/S	ACM N/S N/S
	ROOM 24	O	*	
	ROOM 25	O	*	
	ROOM 26	O	*	
	ROOM 27	O	*	
	POD 2	O	*	
	ROOM 28	O	*	
	ROOM 29	O	*	
	ROOM 30	O	*	
	ROOM 31	O	*	
	ROOM 32	O	*	
	ROOM 33	O	*	
	POD 3	O	*	
	ROOM 34	O	*	
	ROOM 34A	O	*	
	BOY'S RESTROOM 3	O	*	
	GIRL'S RESTROOM 3	O	*	
	JANITOR 3	O	*	
	ROOM 35	O	*	
	ROOM 35A	O	*	
	ROOM 35B	O	*	
	WEST WING	O	*	
	STAGE	O	*	
	EAST WING	O	*	
	ROOM 36	O	*	
	ROOM 37	O	*	
	ROOM 38	O	*	
	ROOM 38A	O	*	
	ROOM 66	O	*	

JOB NAME: *Comprehensive AHERA Asbestos Inspection
Kyrene De La Esperanza Elementary School, KSD
Main Building*

JOB NO. 08-085

MATERIAL DESCRIPTION	MATERIAL LOCATION	MATERIAL COMPONENT C/W/F/O	COMPONENT LOCATION N/E/W/S	ACM N/S
	ROOM 66A	O	*	
	ROOM 67	O	*	
	ROOM 39	O	*	
	ROOM 40	O	*	
	ROOM 41	O	*	
	ROOM 41A	O	*	
	GIRL'S RESTROOM 2	O	*	
	BOY'S RESTROOM 2	O	*	
	JANITOR 2	O	*	
	ROOM 42	O	*	
	ROOM 43	O	*	
	ROOM 44	O	*	
	ROOM 45	O	*	
	ROOM 46	O	*	
	ROOM 47	O	*	
	POD 4	O	*	
	ROOM 48	O	*	
	ROOM 49	O	*	
	ROOM 50	O	*	
	ROOM 51	O	*	
	ROOM 52	O	*	
	ROOM 53	O	*	
	POD 5	O	*	
	FOYER 1	O	*	
	ROOM 54	O	*	
	ROOM 55	O	*	
	ROOM 55A	O	*	
	ROOM 56	O	*	

JOB NAME: *Comprehensive AHERA Asbestos Inspection
Kyrene De La Esperanza Elementary School, KSD
Main Building*

JOB NO. 08-085

MATERIAL DESCRIPTION	MATERIAL LOCATION	MATERIAL COMPONENT C/W/F/O	COMPONENT LOCATION N/E/W/S	ACM N/S N/S
	ROOM 56A	O	*	
	ROOM 57	O	*	
	ROOM 57A	O	*	
	ROOM 58	O	*	
	ROOM 59	O	*	
	ROOM 59A	O	*	
	ROOM 59B	O	*	
	ROOM 60	O	*	
	ROOM 61	O	*	
	ROOM 61A	O	*	
	FOYER 2	O	*	
	ROOM 62	O	*	
	ROOM 62A	O	*	
	ROOM 63	O	*	
	ROOM 63A	O	*	
	CORRIDOR C-01	O	*	
	CORRIDOR C-02	O	*	
	CORRIDOR C-03	O	*	
	CORRIDOR C-04	O	*	
	CORRIDOR C-05	O	*	
	CORRIDOR C-06	O	*	
	CORRIDOR C-07	O	*	
	CORRIDOR C-08	O	*	
	CORRIDOR C-09	O	*	
	CORRIDOR C-10	O	*	
	CORRIDOR C-11	O	*	
	CORRIDOR C-12	O	*	
	CORRIDOR C-13	O	*	

JOB NAME: *Comprehensive AHERA Asbestos Inspection
Kyrene De La Esperanza Elementary School, KSD
Main Building*

JOB NO. 08-085

MATERIAL DESCRIPTION	MATERIAL LOCATION	MATERIAL COMPONENT	COMPONENT LOCATION	ACM N/S
		C/W/F/O	N/E/W/S	N/S
GLAZED WALL TILE, 4"X4", TAN, SMOOTH	GIRL'S RESTROOM 1	W	N, E, W, S	S
	BOY'S RESTROOM 1	W	N, E, W, S	
	BOY'S RESTROOM 3	W	N, E, W, S	
	GIRL'S RESTROOM 3	W	N, E, W, S	
	ROOM 66	W	N, E, W, S	
	ROOM 67	W	N, E, W, S	
	GIRL'S RESTROOM 2	W	N, E, W, S	
	BOY'S RESTROOM 2	W	N, E, W, S	
	ROOM 62	W	N, E, W, S	
	ROOM 63	W	N, E, W, S	
GLAZED WALL TILE (PATTERN), 4"X4", BLUE, SMOOTH	GIRL'S RESTROOM 1	W	N, E, W, S	S
	BOY'S RESTROOM 1	W	N, E, W, S	
	BOY'S RESTROOM 3	W	N, E, W, S	
	GIRL'S RESTROOM 3	W	N, E, W, S	
	ROOM 66	W	N, E, W, S	
	ROOM 67	W	N, E, W, S	
	GIRL'S RESTROOM 2	W	N, E, W, S	
	BOY'S RESTROOM 2	W	N, E, W, S	
	ROOM 62	W	N, E, W, S	
	ROOM 63	W	N, E, W, S	
GROUT, GRAY, CEMENTITIOUS, ASSOCIATED WITH GLAZED WALL TILE, 4"X4", TAN, SMOOTH AND GLAZED WALL TILE (PATTERN), 4"X4", BLUE, SMOOTH	GIRL'S RESTROOM 1	W	N, E, W, S	S
	BOY'S RESTROOM 1	W	N, E, W, S	
	BOY'S RESTROOM 3	W	N, E, W, S	
	GIRL'S RESTROOM 3	W	N, E, W, S	
	ROOM 66	W	N, E, W, S	
	ROOM 67	W	N, E, W, S	
	GIRL'S RESTROOM 2	W	N, E, W, S	

JOB NAME: *Comprehensive AHERA Asbestos Inspection
Kyrene De La Esperanza Elementary School, KSD
Main Building*

JOB NO. 08-085

MATERIAL DESCRIPTION	MATERIAL LOCATION	MATERIAL COMPONENT C/W/F/O	COMPONENT LOCATION N/E/W/S	ACM N/S
	BOY'S RESTROOM 2	W	N, E, W, S	
	ROOM 62	W	N, E, W, S	
	ROOM 63	W	N, E, W, S	
CERAMIC MOSAIC TILE, 2"X2", TAN, SMOOTH, PEPPERED	GIRL'S RESTROOM 1	F	*	S
	BOY'S RESTROOM 1	F	*	
	BOY'S RESTROOM 3	F	*	
	GIRL'S RESTROOM 3	F	*	
	ROOM 66	F	*	
	ROOM 67	F	*	
	GIRL'S RESTROOM 2	F	*	
	BOY'S RESTROOM 2	F	*	
	ROOM 62	F	*	
	ROOM 63	F	*	
GROUT, GRAY, CEMENTITIOUS, ASSOCIATED WITH CERAMIC MOSAIC TILE, 2"X2", TAN, SMOOTH, PEPPERED	GIRL'S RESTROOM 1	F	*	S
	BOY'S RESTROOM 1	F	*	
	BOY'S RESTROOM 3	F	*	
	GIRL'S RESTROOM 3	F	*	
	ROOM 66	F	*	
	ROOM 67	F	*	
	GIRL'S RESTROOM 2	F	*	
	BOY'S RESTROOM 2	F	*	
	ROOM 62	F	*	
	ROOM 63	F	*	
FIBERGLASS REINFORCED PANEL, WHITE, TEXTURED	ROOM 37	W	E, W, S	N
	JANITOR 2	W	N, E	
	ROOM 62A	W	N, E	
ADHESIVE, BROWN, BRITTLE, ASSOCIATED WITH FIBERGLASS REINFORCED PANEL, WHITE, TEXTURED	ROOM 37	W	E, W, S	S

JOB NAME: *Comprehensive AHERA Asbestos Inspection
Kyrene De La Esperanza Elementary School, KSD
Main Building*

JOB NO. 08-085

MATERIAL DESCRIPTION	MATERIAL LOCATION	MATERIAL COMPONENT C/W/F/O	COMPONENT LOCATION N/E/W/S	ACM N/S
	JANITOR 2	W	N, E	
	ROOM 62A	W	N, E	
PIPE SEALANT, GREEN, GUMMY	CHILLER YARD	O	*	S
SEALANT (EQUIPMENT), BLACK, GUMMY	CHILLER YARD	O	*	S
ACOUSTICAL CEILING PANEL, 2'X2', YELLOW, FIBROUS GLASS, CLOTH COVER	ROOM 54	C	*	S
	ROOM 57	C	*	S
VINYL COMPOSITION TILE (STRIP), 2"X24", RED, SMOOTH	ROOM 35	F	*	S
VINYL COMPOSITION TILE (STRIP), 2"X24", BLUE, SMOOTH	ROOM 35	F	*	S
VINYL COMPOSITION TILE (STRIP), 2"X24", BLACK, SMOOTH	ROOM 35	F	*	S
VINYL COMPOSITION TILE (STRIP), 2"X24", YELLOW, SMOOTH	ROOM 35	F	*	S
VINYL COMPOSITION TILE (STRIP), 2"X24", GREEN, SMOOTH	ROOM 35	F	*	S
ACOUSTICAL CEILING PANEL, 2"X4", WHITE, CHALKY, VINYL COVER	ROOM 37	C	*	S
SPRAY-APPLIED TEXTURE, WHITE, CHALKY	ENTRY	C, W	N, E, W, S	S
	KITCHEN	C, W	N, E, W, S	
	BEDROOM 1	C, W	N, E, W, S	
	RESTROOM 1	C, W	N, E, W, S	
	LIVING ROOM	C, W	N, E, W, S	
	RESTROOM 2	C, W	N, E, W, S	
	BEDROOM 2	C, W	N, E, W, S	
GYPSUM WALLBOARD, WHITE, CHALKY, ASSOCIATED WITH SPRAY-APPLIED TEXTURE, WHITE, CHALKY	ENTRY	C, W	N, E, W, S	S
	KITCHEN	C, W	N, E, W, S	
	BEDROOM 1	C, W	N, E, W, S	
	RESTROOM 1	C, W	N, E, W, S	
	LIVING ROOM	C, W	N, E, W, S	
	RESTROOM 2	C, W	N, E, W, S	
	BEDROOM 2	C, W	N, E, W, S	
JOINT COMPOUND, WHITE, CHALKY, ASSOCIATED WITH GYPSUM WALLBOARD, WHITE, CHALKY	ENTRY	C, W	N, E, W, S	S

JOB NAME: *Comprehensive AHERA Asbestos Inspection
Kyrene De La Esperanza Elementary School, KSD
Main Building*

JOB NO. 08-085

MATERIAL DESCRIPTION	MATERIAL LOCATION	MATERIAL COMPONENT	COMPONENT LOCATION	ACM N/S
		C/W/F/O	N/E/W/S	N/S
	KITCHEN	C, W	N, E, W, S	
	BEDROOM 1	C, W	N, E, W, S	
	RESTROOM 1	C, W	N, E, W, S	
	LIVING ROOM	C, W	N, E, W, S	
	RESTROOM 2	C, W	N, E, W, S	
	BEDROOM 2	C, W	N, E, W, S	
QUARRY/PAVER TILE, 8"X8", WHITE, SMOOTH	ENTRY	F	*	S
GROUT, GRAY, CEMENTITIOUS, ASSOCIATED WITH QUARRY/PAVER TILE, 8"X8", WHITE, SMOOTH	ENTRY	F	*	S
VINYL SHEET FLOORING, BLUE, SMOOTH, WHITE MOTTLES, GRAY PAPER BACKING	KITCHEN	F	*	S
	RESTROOM 1	F	*	
	RESTROOM 2	F	*	
MASTIC, YELLOW, TACKY, ASSOCIATED WITH VINYL SHEET FLOORING, BLUE, SMOOTH, WHITE MOTTLES, GRAY PAPER BACKING	KITCHEN	F	*	S
	RESTROOM 1	F	*	
	RESTROOM 2	F	*	
CARPET, BROWN, FIBROUS	BEDROOM 1	F	*	S
	LIVING ROOM	F	*	
	BEDROOM 2	F	*	
MASTIC, YELLOW, TACKY, ASSOCIATED WITH CARPET, BROWN, FIBROUS	BEDROOM 1	F	*	S
	LIVING ROOM	F	*	
	BEDROOM 2	F	*	
GLAZED WALL TILE, 4"X4", WHITE, SMOOTH	RESTROOM 1	W	N, W, S	S
	RESTROOM 2	W	N, W, S	
GROUT, GRAY, CEMENTITIOUS, ASSOCIATED WITH GLAZED WALL TILE, 4"X4", WHITE, SMOOTH	RESTROOM 1	W	N, W, S	S
	RESTROOM 2	W	N, W, S	
SEALANT (DOORS, WINDOWS, MILLWORK, FIXTURES), WHITE, PLIABLE	ENTRY	O	W	S
	KITCHEN	O	N, E, W, S	
	BEDROOM 1	O	N, W	

JOB NAME: *Comprehensive AHERA Asbestos Inspection
Kyrene De La Esperanza Elementary School, KSD
Main Building*

JOB NO. 08-085

<i>MATERIAL DESCRIPTION</i>	<i>MATERIAL LOCATION</i>	<i>MATERIAL COMPONENT</i>	<i>COMPONENT LOCATION</i>	<i>ACM N/S</i>
		<i>C/W/F/O</i>	<i>N/E/W/S</i>	<i>N/S</i>
	RESTROOM 1	O	E, W, S	
	RESTROOM 2	O	N, W	
	BEDROOM 2	O	N, S	
GLASS BLOCK, 4'X4", RIBBED	ENTRY	O	E	N
GROUT, GRAY, CEMENTITIOUS, ASSOCIATED WITH GLASS BLOCK, 4'X4", RIBBED	ENTRY	O	E	S

* - *Not Applicable*

END OF TABLE

JOB NAME: *Comprehensive AHERA Asbestos Inspection
Kyrene De La Esperanza Elementary School, KSD
Portable 71/72*

JOB NO. 08-085

**TABLE A
BUILDING MATERIAL SYSTEMS**

MATERIAL DESCRIPTION	MATERIAL LOCATION	MATERIAL COMPONENT	COMPONENT LOCATION	ACM N/S
		C/W/F/O	N/E/W/S	N/S
CONCRETE MASONRY UNIT, 8"X16", GRAY, CEMENTITIOUS, 8"X8" PATTERN	EXTERIOR	W	E, S	S
MORTAR, GRAY, CEMENTITIOUS, ASSOCIATED WITH CONCRETE MASONRY UNIT, 8"X16", GRAY, CEMENTITIOUS, 8"X8" PATTERN	EXTERIOR	W	E, S	S
CONCRETE (ENTRIES), GRAY, CEMENTITIOUS	EXTERIOR	F	*	S
BUILT-UP ROOFING, BLACK, ASPHALTIC, GRAY MINERAL CAP	ROOF	O	*	S
MASTIC (PENETRATIONS AND FLASHINGS), BLACK, TAR-LIKE	ROOF	O	*	S
SIDING (METAL), PAINTED	EXTERIOR	W	N, E, W, S	N
SEALANT (WINDOWS), BLACK, PLIABLE	EXTERIOR	O	N	S
SEALANT (DOORS, MILLWORK), WHITE, PLIABLE	P71	O	W	S
	P72	O	E	
	EXTERIOR	O	N	
FIRE DOOR INSULATION, METAL CLADDING	P71	O	N	S
	P72	O	N	
	EXTERIOR	O	N	
ACOUSTICAL CEILING PANEL, 2'X4', GRAY, PINHOLES AND FISSURES, WHITE	P71	C	*	S
	P72	C	*	
SPRAY-APPLIED TEXTURE, WHITE, CHALKY	P71	W	N, E, W, S	S
	P72	W	N, E, W, S	
GYPHUM WALLBOARD, WHITE, CHALKY, ASSOCIATED WITH SPRAY-APPLIED TEXTURE, WHITE, CHALKY	P71	W	N, E, W, S	S
	P72	W	N, E, W, S	
JOINT COMPOUND, WHITE, CHALKY, ASSOCIATED WITH GYPHUM WALLBOARD, WHITE, CHALKY	P71	W	N, E, W, S	S
	P72	W	N, E, W, S	
TACKABLE WALL PANEL, BROWN, FIBROUS, VINYL COVER	P71	W	N, E, S	S
	P72	W	N, W, S	
SINK ACOUSTICAL COATING, BLACK, ROUGH	P71	O	W	S
	P72	O	E	

JOB NAME: *Comprehensive AHERA Asbestos Inspection
Kyrene De La Esperanza Elementary School, KSD
Portable 71/72*

JOB NO. 08-085

MATERIAL DESCRIPTION	MATERIAL LOCATION	MATERIAL COMPONENT	COMPONENT LOCATION	ACM N/S
		C/W/F/O	N/E/W/S	N/S
SINK ACOUSTICAL COATING, GRAY, ROUGH	P71	O	W	S
	P72	O	E	
WALLBASE (COVED), 4", BLACK, VINYL-LIKE	P71	O	N, E, W, S	S
	P72	O	N, E, W, S	
ADHESIVE, CREAM, PLIABLE, ASSOCIATED WITH WALLBASE (COVED), 4", BLACK, VINYL-LIKE	P71	O	N, E, W, S	S
	P72	O	N, E, W, S	
CARPET, BLUE, FIBROUS, MULTI-COLORED	P71	F	*	S
	P72	F	*	
MASTIC, YELLOW, TACKY, ASSOCIATED WITH CARPET, BLUE, FIBROUS, MULTI-COLORED	P71	F	*	S
	P72	F	*	
DUCT SEAM TAPE, 4", WHITE, CANVAS-LIKE	P71	O	*	S
	P72	O	*	

* - *Not Applicable*

END OF TABLE

JOB NAME: *Comprehensive AHERA Asbestos Inspection
Kyrene De La Esperanza Elementary School, KSD
Portable 73/74*

JOB NO. 08-085

**TABLE A
BUILDING MATERIAL SYSTEMS**

MATERIAL DESCRIPTION	MATERIAL LOCATION	MATERIAL COMPONENT	COMPONENT LOCATION	ACM N/S
		C/W/F/O	N/E/W/S	N/S
CONCRETE MASONRY UNIT, 8"X16", GRAY, CEMENTITIOUS	EXTERIOR	W	W, S	S
MORTAR, GRAY, CEMENTITIOUS, ASSOCIATED WITH CONCRETE MASONRY UNIT, 8"X16", GRAY, CEMENTITIOUS	EXTERIOR	W	W, S	S
CONCRETE (ENTRIES), GRAY, CEMENTITIOUS	EXTERIOR	F	*	S
BUILT-UP ROOFING, BLACK, ASPHALTIC, GRAY MINERAL CAP	ROOF	O	*	S
MASTIC (PENETRATIONS AND FLASHINGS), BLACK, TAR-LIKE	ROOF	O	*	S
SIDING (METAL), PAINTED	EXTERIOR	W	N, E, W, S	N
SEALANT (WINDOWS), BLACK, PLIABLE	EXTERIOR	O	N	S
SEALANT (DOORS, WINDOWS), WHITE, PLIABLE	P73	O	W	S
	P74	O	E	
	EXTERIOR	O	N	
FIRE DOOR INSULATION, METAL CLADDING	P73	O	N	S
	P74	O	N	
	EXTERIOR	O	N	
ACOUSTICAL CEILING PANEL, 2'X4', GRAY, PINHOLES AND FISSURES, WHITE	P73	C	*	S
	P74	C	*	
SPRAY-APPLIED TEXTURE, WHITE, CHALKY	P73	W	N, E, W, S	S
	P74	W	N, E, W, S	
GYPSUM WALLBOARD, WHITE, CHALKY, ASSOCIATED WITH SPRAY-APPLIED TEXTURE, WHITE, CHALKY	P73	W	N, E, W, S	S
	P74	W	N, E, W, S	
JOINT COMPOUND, WHITE, CHALKY, ASSOCIATED WITH GYPSUM WALLBOARD, WHITE, CHALKY	P73	W	N, E, W, S	S
	P74	W	N, E, W, S	
TACKABLE WALL PANEL, BROWN, FIBROUS, GRAY VINYL COVER	P73	W	N, E, S	S
	P74	W	N, W, S	
SINK ACOUSTICAL COATING, BLACK, ROUGH	P73	O	W	S
	P74	O	E	

JOB NAME: *Comprehensive AHERA Asbestos Inspection
Kyrene De La Esperanza Elementary School, KSD
Portable 73/74*

JOB NO. 08-085

MATERIAL DESCRIPTION	MATERIAL LOCATION	MATERIAL COMPONENT	COMPONENT LOCATION	ACM N/S
		<i>C/W/F/O</i>	<i>N/E/W/S</i>	<i>N/S</i>
WALLBASE (COVED), 4", BLACK, VINYL-LIKE	P73	O	N, E, W, S	S
	P74	O	N, E, W, S	
ADHESIVE, CREAM, PLIABLE, ASSOCIATED WITH WALLBASE (COVED), 4", BLACK, VINYL-LIKE	P73	O	N, E, W, S	S
	P74	O	N, E, W, S	
CARPET, BLUE, FIBROUS, MULTI-COLORED	P73	F	*	S
	P74	F	*	
MASTIC, YELLOW, TACKY, ASSOCIATED WITH CARPET, BLUE, FIBROUS, MULTI-COLORED	P73	F	*	S
	P74	F	*	
DUCT SEAM TAPE, 4", WHITE, CANVAS-LIKE	P73	O	*	S
	P74	O	*	
VINYL COMPOSITION TILE, 12"X12", OFF-WHITE, SMOOTH, WHITE MOTTLES	P73	F	*	S
	P74	F	*	
VINYL COMPOSITION TILE, 12"X12", TAN, SMOOTH, TAN MOTTLES	P73	F	*	S
	P74	F	*	
MASTIC, YELLOW, TACKY, ASSOCIATED WITH VINYL COMPOSITION TILE, 12"X12", OFF-WHITE, SMOOTH, WHITE MOTTLES AND VINYL COMPOSITION TILE, 12"X12", TAN, SMOOTH, TAN MOTTLES	P73	F	*	S
	P74	F	*	

* - *Not Applicable*

END OF TABLE

2.4 AHERA Inspection Procedures and Protocols

2.4.1 Inspection Procedures and Protocols

The EPA's AHERA inspection procedures and sampling protocols as called-out in the AHERA Regulations (40 CFR Part 763) requires that all Asbestos-Containing Materials (ACM) utilized within the structure of a regulated "school" building which are called ACBM:

- be identified and located
- be classified as an assumed ACBM or,
- be sampled and analyzed to prove they are NOT ACBM
- be assessed for;
 - ◊ natural friability and,
 - ◊ physical condition and,
 - ◊ if damaged or thermal systems insulation;
 - * be identified for an immediate response action or,
 - * be identified for possible future disturbance and
 - * have preventative measures to reduce potential damage identified.
- have all the forgoing activities conducted and recorded in such a manner as to be able to track;
 - ◊ date accomplished and,
 - ◊ identification and qualification of individuals conducting each activity.

2.4.2 FM GROUP INC Inspection SOP

FM's inspection procedures and protocols have been developed into a logical step-by-step process designated to accomplish both EPA's AHERA and OSHA's mandates. During inspections, FM will always endeavor to identify all ACM in a structure, whether ACBM or not, so as to limit the possibilities of accidental exposure to contractors or employees during future maintenance or remodeling activities.

2.5 Visual Inspection

A visual inspection of the three buildings was conducted to locate and identify Homogeneous Areas (HA) of suspect ACBM. A HA is defined as an area in which the suspect material appears to be uniform in texture, color, and wear and believed to have been applied during the same general time period. All materials excluding wood; glass; metal; fibrous glass, glass foam and rubber thermal insulation were considered suspect.

A detailed description of HA's of suspect ACBM's is presented as Table B in Section 2.6.

2.6 Homogeneous Areas of Suspect Asbestos-Containing Building Materials

**TABLE B
HOMOGENEOUS AREAS OF SUSPECT CONTAINING BUILDING MATERIALS**

**MAIN BUILDING
PORTABLE P71/72
PORTABLE P73/74**

JOB NAME: *Comprehensive AHERA Asbestos Inspection
Kyrene De La Esperanza Elementary School, KSD
Main Building*

JOB NO. 08-085

**TABLE B
HOMOGENEOUS AREAS OF SUSPECT CONTAINING BUILDING MATERIALS**

MATERIAL CODE	MATERIAL DESCRIPTION	CLSS MTHD	F/NF	MTL QUAN	UNITS
M-CMU-01	CONCRETE MASONRY UNIT, 4"X16", GRAY, CEMENTITIOUS	S	NF	8,000	SF
M-CMU-02	CONCRETE MASONRY UNIT, 4"X16", RED, CEMENTITIOUS	S	NF	10,000	SF
M-CMU-03	CONCRETE MASONRY UNIT, 8"X16", GRAY, CEMENTITIOUS, TEXTURED	S	NF	3,000	SF
M-CMU-04	CONCRETE MASONRY UNIT, 8"X16", GRAY, CEMENTITIOUS, 8"X8" PATTERN	S	NF	3,000	SF
M-MRT-05	MORTAR, GRAY, CEMENTITIOUS, ASSOCIATED WITH CONCRETE MASONRY UNIT, 4"X16", GRAY, CEMENTITIOUS AND CONCRETE MASONRY UNIT, 4"X16", RED, CEMENTITIOUS AND CONCRETE MASONRY UNIT, 8"X16", GRAY, CEMENTITIOUS, TEXTURED AND CONCRETE MASONRY UNIT, 8"X16", GRAY, CEMENTITIOUS, 8"X8" PATTERN	S	NF	2,000	SF
M-SLT-06	SEALANT (EXPANSION), GRAY, PLIABLE	S	NF	80	SF
M-QPT-07	QUARRY/PAVER TILE, 8"X8", RED, SMOOTH	A	NF	13	SF
M-MRT-08	MORTAR, WHITE, CEMENTITIOUS, ASSOCIATED WITH GLASS BLOCK, 8"X8", RIBBED	S	NF	50	SF
M-SLT-09	SEALANT (DOORS, WINDOWS), WHITE, PLIABLE	S	NF	40	SF
M-GWT-10	GLAZED WALL TILE, 8"X8", WHITE, SMOOTH, MULTI-COLORED, HAND PAINTED DESIGNS	A	NF	120	SF
M-GRT-11	GROUT, GRAY, CEMENTITIOUS, ASSOCIATED WITH GLAZED WALL TILE, 8"X8", WHITE, SMOOTH, MULTI-COLORED, HAND PAINTED DESIGNS	A	NF	12	SF
M-CON-12	CONCRETE (ENTRIES), GRAY, CEMENTITIOUS	S	NF	25,000	SF
M-CON-13	CONCRETE (FOUNDATION), GRAY, CEMENTITIOUS	S	NF	60,000	SF
M-CON-14	CONCRETE (EQUIPMENT PAD), GRAY, CEMENTITIOUS	A	NF	1,000	SF
M-CMU-15	CONCRETE MASONRY UNIT, 8"X16", GRAY, CEMENTITIOUS, TEXTURED	S	NF	1,500	SF
M-CMU-16	CONCRETE MASONRY UNIT, 4"X16", RED, CEMENTITIOUS	S	NF	1,500	SF
M-MRT-17	MORTAR, GRAY, CEMENTITIOUS, ASSOCIATED WITH CONCRETE MASONRY UNIT, 8"X16", GRAY, CEMENTITIOUS, TEXTURED AND CONCRETE MASONRY UNIT, 4"X16", RED, CEMENTITIOUS	S	NF	300	SF
M-BUR-18	BUILT-UP ROOFING, BLACK, ASPHALTIC, GRAY MINERAL CAP, SILVER COATING	A	NF	60,000	SF
M-MAS-19	MASTIC (PENETRATIONS AND FLASHINGS), BLACK, TAR-LIKE	A	NF	100	SF
S-TOT-20	TROWELED-ON TEXTURE (SERVICE AREAS), WHITE, CHALKY	S	NF	900	SF
M-GWB-21	GYPHUM WALLBOARD, WHITE, CHALKY, ASSOCIATED WITH TROWELED-ON TEXTURE (SERVICE AREAS), WHITE, CHALKY	S	NF	900	SF
S-JTC-22	JOINT COMPOUND, WHITE, CHALKY, ASSOCIATED WITH GYPHUM WALLBOARD, WHITE, CHALKY	S	NF	90	SF
M-VCT-23	VINYL COMPOSITION TILE, 12"X12", TAN, SMOOTH, TAN MOTTLES	S	NF	25,000	SF

JOB NAME: *Comprehensive AHERA Asbestos Inspection
Kyrene De La Esperanza Elementary School, KSD
Main Building*

JOB NO. 08-085

MATERIAL CODE	MATERIAL DESCRIPTION	CLSS MTHD	F/NF	MTL QUAN	UNITS
M·MAS·24	MASTIC, YELLOW, TACKY, ASSOCIATED WITH VINYL COMPOSITION TILE, 12"X12", TAN, SMOOTH AND VINYL COMPOSITION TILE, 12"X12", PINK, SMOOTH, TAN MOTTLES AND VINYL COMPOSITION TILE (STRIP), 2"X24", RED, SMOOTH, TAN MOTTLES AND VINYL COMPOSITION TILE (STRIP), 2"X24", BLUE, SMOOTH AND VINYL COMPOSITION TILE (STRIP), 2"X24", BLACK, SMOOTH AND VINYL COMPOSITION TILE (STRIP), 2"X24", YELLOW AND VINYL COMPOSITION TILE (STRIP), 2"X24", GREEN, SMOOTH	S	NF	25,000	SF
M·WAB·25	WALLBASE (COVERED), 4", BLUE, VINYL-LIKE	S	NF	1,500	SF
M·ADH·26	ADHESIVE, CREAM, PLIABLE, ASSOCIATED WITH WALLBASE (COVERED), 4", BLUE, VINYL-LIKE	S	NF	1,500	SF
M·FDI·27	FIRE DOOR INSULATION, WOOD CLADDING	A	NF	1,806	SF
M·PSL·28	PIPE SEALANT, YELLOW, PLIABLE	A	NF	75	SF
S·SAT·29	SPRAY-APPLIED TEXTURE (RESTROOMS), WHITE, CHALKY	S	NF	5,000	SF
M·GWB·30	GYPSUM WALLBOARD, WHITE, CHALKY, ASSOCIATED WITH SPRAY-APPLIED TEXTURE (RESTROOMS), WHITE, CHALKY	S	NF	5,000	SF
S·JTC·31	JOINT COMPOUND, WHITE, CHALKY, ASSOCIATED WITH GYPSUM WALLBOARD, WHITE, CHALKY	S	NF	500	SF
M·SLT·32	SEALANT (DOORS, WINDOWS, MILLWORK, FIXTURES), WHITE, PLIABLE	S	NF	200	SF
M·CPT·33	CARPET, GRAY, FIBROUS, MULTI-COLORED, SELF-STICK	S	NF	35,000	SF
M·APL·35	ACOUSTICAL CEILING PANEL, 2'X2', GRAY, PINHOLES AND FISSURES, WHITE	S	F	50,000	SF
S·SAT·36	SPRAY-APPLIED TEXTURE (CLASSROOMS, OFFICES), WHITE, CHALKY	S	NF	50,000	SF
M·GWB·37	GYPSUM WALLBOARD, WHITE, CHALKY, ASSOCIATED WITH SPRAY-APPLIED TEXTURE (CLASSROOMS, OFFICES), WHITE, CHALKY	S	NF	50,000	SF
S·JTC·38	JOINT COMPOUND, WHITE, CHALKY, ASSOCIATED WITH GYPSUM WALLBOARD, WHITE, CHALKY	S	NF	5,000	SF
S·SAT·39	SPRAY-APPLIED TEXTURE (CORRIDORS), WHITE, CHALKY	S	NF	20,000	SF
M·GWB·40	GYPSUM WALLBOARD, WHITE, CHALKY, ASSOCIATED WITH SPRAY-APPLIED TEXTURE (CORRIDORS), WHITE, CHALKY	S	NF	20,000	SF
S·JTC·41	JOINT COMPOUND, WHITE, CHALKY, ASSOCIATED WITH GYPSUM WALLBOARD, WHITE, CHALKY	S	NF	2,000	SF
M·SAC·42	SINK ACOUSTICAL COATING, GRAY, ROUGH	S	NF	88	SF
M·SLT·43	SEALANT (DOORS, WINDOWS, MILLWORK), BLACK, GUMMY	S	NF	52	SF
M·FDI·44	FIRE DOOR INSULATION, METAL CLADDING	A	NF	903	SF
M·TWP·45	TACKABLE WALL PANEL, BROWN, FIBROUS, VINYL COVER	S	NF	8,000	SF
M·VCT·46	VINYL COMPOSITION TILE, 24"X24", BLUE, CIRCLE PATTERN	S	NF	300	SF
M·MAS·47	MASTIC, YELLOW, TACKY, ASSOCIATED WITH VINYL COMPOSITION TILE, 24"X24", BLUE, CIRCLE PATTERN	S	NF	300	SF
M·VCT·48	VINYL COMPOSITION TILE (PATTERN), 12"X12", PINK, SMOOTH, TAN MOTTLES	S	NF	80	SF
M·SLT·49	SEALANT (DUCT), WHITE, PLIABLE	S	NF	150	SF
M·DST·50	DUCT SEAM TAPE, 4", WHITE, CANVAS-LIKE	S	NF	150	SF
M·GWT·51	GLAZED WALL TILE, 4"X4", TAN, SMOOTH	A	NF	5,000	SF
M·GWT·52	GLAZED WALL TILE (PATTERN), 4"X4", BLUE, SMOOTH	A	NF	1,000	SF

JOB NAME: *Comprehensive AHERA Asbestos Inspection
Kyrene De La Esperanza Elementary School, KSD
Main Building*

JOB NO. 08-085

MATERIAL CODE	MATERIAL DESCRIPTION	CLSS MTHD	F/NF	MTL QUAN	UNITS
M·GRT·53	GROUT, GRAY, CEMENTITIOUS, ASSOCIATED WITH GLAZED WALL TILE, 4"X4", TAN, SMOOTH AND GLAZED WALL TILE (PATTERN), 4"X4", BLUE, SMOOTH	A	NF	600	SF
M·CMT·54	CERAMIC MOSAIC TILE, 2"X2", TAN, SMOOTH, PEPPERED	A	NF	3,200	SF
M·GRT·55	GROUT, GRAY, CEMENTITIOUS, ASSOCIATED WITH CERAMIC MOSAIC TILE, 2"X2", TAN, SMOOTH, PEPPERED	A	NF	320	SF
M·ADH·56	ADHESIVE, BROWN, BRITTLE, ASSOCIATED WITH FIBERGLASS REINFORCED PANEL, WHITE, TEXTURED	A	NF	100	SF
M·PSL·57	PIPE SEALANT, GREEN, GUMMY	A	NF	2	SF
M·SLT·58	SEALANT (EQUIPMENT), BLACK, GUMMY	A	NF	2	SF
M·APL·59	ACOUSTICAL CEILING PANEL, 2'X2', YELLOW, FIBROUS GLASS, CLOTH COVER	A	NF	1,750	SF
M·VCT·60	VINYL COMPOSITION TILE (STRIP), 2"X24", RED, SMOOTH	S	NF	5	SF
M·VCT·61	VINYL COMPOSITION TILE (STRIP), 2"X24", BLUE, SMOOTH	S	NF	5	SF
M·VCT·62	VINYL COMPOSITION TILE (STRIP), 2"X24", BLACK, SMOOTH	S	NF	5	SF
M·VCT·63	VINYL COMPOSITION TILE (STRIP), 2"X24", YELLOW, SMOOTH	S	NF	5	SF
M·VCT·64	VINYL COMPOSITION TILE (STRIP), 2"X24", GREEN, SMOOTH	S	NF	5	SF
M·APL·65	ACOUSTICAL CEILING PANEL, 2"X4", WHITE, CHALKY, VINYL COVER	S	NF	600	SF
S·SAT·66	SPRAY-APPLIED TEXTURE, WHITE, CHALKY	A	NF	3,000	SF
M·GWB·67	GYPSUM WALLBOARD, WHITE, CHALKY, ASSOCIATED WITH SPRAY-APPLIED TEXTURE, WHITE, CHALKY	A	NF	3,000	SF
S·JTC·68	JOINT COMPOUND, WHITE, CHALKY, ASSOCIATED WITH GYPSUM WALLBOARD, WHITE, CHALKY	A	NF	300	SF
M·QPT·69	QUARRY/PAVER TILE, 8"X8", WHITE, SMOOTH	A	NF	30	SF
M·GRT·70	GROUT, GRAY, CEMENTITIOUS, ASSOCIATED WITH QUARRY/PAVER TILE, 8"X8", WHITE, SMOOTH	A	NF	3	SF
M·VSF·71	VINYL SHEET FLOORING, BLUE, SMOOTH, WHITE MOTTLES, GRAY PAPER BACKING	A	NF	1,200	SF
M·MAS·72	MASTIC, YELLOW, TACKY, ASSOCIATED WITH VINYL SHEET FLOORING, BLUE, SMOOTH, WHITE MOTTLES, GRAY PAPER BACKING	A	NF	1,200	SF
M·CPT·73	CARPET, BROWN, FIBROUS	A	NF	1,200	SF
M·MAS·74	MASTIC, YELLOW, TACKY, ASSOCIATED WITH CARPET, BROWN, FIBROUS	A	NF	1,200	SF
M·GWT·75	GLAZED WALL TILE, 4"X4", WHITE, SMOOTH	A	NF	60	SF
M·GRT·76	GROUT, GRAY, CEMENTITIOUS, ASSOCIATED WITH GLAZED WALL TILE, 4"X4", WHITE, SMOOTH	A	NF	60	SF
M·SLT·77	SEALANT (DOORS, WINDOWS, MILLWORK, FIXTURES), WHITE, PLIABLE	A	NF	11	SF
M·GRT·78	GROUT, GRAY, CEMENTITIOUS, ASSOCIATED WITH GLASS BLOCK, 4"X4", RIBBED	A	NF	2	SF

END OF TABLE

JOB NAME: *Comprehensive AHERA Asbestos Inspection
Kyrene De La Esperanza Elementary School, KSD
Portable 71/72*

JOB NO. 08-085

**TABLE B
HOMOGENEOUS AREAS OF SUSPECT CONTAINING BUILDING MATERIALS**

MATERIAL CODE	MATERIAL DESCRIPTION	CLSS MTHD	F/NF	MTL QUAN	UNITS
M-CMU-01	CONCRETE MASONRY UNIT, 8"X16", GRAY, CEMENTITIOUS, 8"X8" PATTERN	A	NF	400	SF
M-MRT-02	MORTAR, GRAY, CEMENTITIOUS, ASSOCIATED WITH CONCRETE MASONRY UNIT, 8"X16", GRAY, CEMENTITIOUS, 8"X8" PATTERN	A	NF	40	SF
M-CON-03	CONCRETE (ENTRIES), GRAY, CEMENTITIOUS	A	NF	800	SF
M-BUR-04	BUILT-UP ROOFING, BLACK, ASPHALTIC, GRAY MINERAL CAP	A	NF	2,000	SF
M-MAS-05	MASTIC (PENETRATIONS AND FLASHINGS), BLACK, TAR-LIKE	A	NF	10	SF
M-SLT-06	SEALANT (WINDOWS), BLACK, PLIABLE	A	NF	6	SF
M-SLT-07	SEALANT (DOORS, MILLWORK), WHITE, PLIABLE	A	NF	6	SF
M-FDI-08	FIRE DOOR INSULATION, METAL CLADDING	A	NF	84	SF
M-APL-09	ACOUSTICAL CEILING PANEL, 2'X4', GRAY, PINHOLES AND FISSURES, WHITE	S	F	2,000	SF
S-SAT-10	SPRAY-APPLIED TEXTURE, WHITE, CHALKY	A	NF	1,500	SF
M-GWB-11	GYPSTUM WALLBOARD, WHITE, CHALKY, ASSOCIATED WITH SPRAY-APPLIED TEXTURE, WHITE, CHALKY	A	NF	1,500	SF
S-JTC-12	JOINT COMPOUND, WHITE, CHALKY, ASSOCIATED WITH GYPSTUM WALLBOARD, WHITE, CHALKY	A	NF	150	SF
M-TWP-13	TACKABLE WALL PANEL, BROWN, FIBROUS, VINYL COVER	A	NF	1,300	SF
M-SAC-14	SINK ACOUSTICAL COATING, BLACK, ROUGH	A	NF	2	SF
M-SAC-15	SINK ACOUSTICAL COATING, GRAY, ROUGH	A	NF	2	SF
M-WAB-16	WALLBASE (COVED), 4", BLACK, VINYL-LIKE	A	NF	60	SF
M-ADH-17	ADHESIVE, CREAM, PLIABLE, ASSOCIATED WITH WALLBASE (COVED), 4", BLACK, VINYL-LIKE	A	NF	60	SF
M-CPT-18	CARPET, BLUE, FIBROUS, MULTI-COLORED	A	NF	2,000	SF
M-MAS-19	MASTIC, YELLOW, TACKY, ASSOCIATED WITH CARPET, BLUE, FIBROUS, MULTI-COLORED	A	NF	2,000	SF
M-DST-20	DUCT SEAM TAPE, 4", WHITE, CANVAS-LIKE	A	F	10	SF

END OF TABLE

JOB NAME: *Comprehensive AHERA Asbestos Inspection
Kyrene De La Esperanza Elementary School, KSD
Portable 73/74*

JOB NO. 08-085

**TABLE B
HOMOGENEOUS AREAS OF SUSPECT CONTAINING BUILDING MATERIALS**

MATERIAL CODE	MATERIAL DESCRIPTION	CLSS MTHD	F/NF	MTL QUAN	UNITS
M-CMU-01	CONCRETE MASONRY UNIT, 8"X16", GRAY, CEMENTITIOUS	A	NF	400	SF
M-MRT-02	MORTAR, GRAY, CEMENTITIOUS, ASSOCIATED WITH CONCRETE MASONRY UNIT, 8"X16", GRAY, CEMENTITIOUS	A	NF	40	SF
M-CON-03	CONCRETE (ENTRIES), GRAY, CEMENTITIOUS	A	NF	800	SF
M-BUR-04	BUILT-UP ROOFING, BLACK, ASPHALTIC, GRAY MINERAL CAP	A	NF	2,000	SF
M-MAS-05	MASTIC (PENETRATIONS AND FLASHINGS), BLACK, TAR-LIKE	A	NF	10	SF
M-SLT-06	SEALANT (WINDOWS), BLACK, PLIABLE	A	NF	6	SF
M-SLT-07	SEALANT (DOORS, WINDOWS), WHITE, PLIABLE	A	NF	6	SF
M-FDI-08	FIRE DOOR INSULATION, METAL CLADDING	A	NF	84	SF
M-APL-09	ACOUSTICAL CEILING PANEL, 2'X4', GRAY, PINHOLES AND FISSURES, WHITE	S	F	2,000	SF
S-SAT-10	SPRAY-APPLIED TEXTURE, WHITE, CHALKY	A	NF	1,500	SF
M-GWB-11	GYPSTUM WALLBOARD, WHITE, CHALKY, ASSOCIATED WITH SPRAY-APPLIED TEXTURE, WHITE, CHALKY	A	NF	1,500	SF
S-JTC-12	JOINT COMPOUND, WHITE, CHALKY, ASSOCIATED WITH GYPSTUM WALLBOARD, WHITE, CHALKY	A	NF	150	SF
M-TWP-13	TACKABLE WALL PANEL, BROWN, FIBROUS, GRAY VINYL COVER	A	NF	1,300	SF
M-SAC-14	SINK ACOUSTICAL COATING, BLACK, ROUGH	A	NF	2	SF
M-WAB-16	WALLBASE (COVED), 4", BLACK, VINYL-LIKE	A	NF	60	SF
M-ADH-17	ADHESIVE, CREAM, PLIABLE, ASSOCIATED WITH WALLBASE (COVED), 4", BLACK, VINYL-LIKE	A	NF	60	SF
M-CPT-18	CARPET, BLUE, FIBROUS, MULTI-COLORED	A	NF	1,500	SF
M-MAS-19	MASTIC, YELLOW, TACKY, ASSOCIATED WITH CARPET, BLUE, FIBROUS, MULTI-COLORED	A	NF	1,500	SF
M-DST-20	DUCT SEAM TAPE, 4", WHITE, CANVAS-LIKE	A	F	10	SF
M-VCT-21	VINYL COMPOSITION TILE, 12"X12", OFF-WHITE, SMOOTH, WHITE MOTTLES	A	NF	250	SF
M-VCT-22	VINYL COMPOSITION TILE, 12"X12", TAN, SMOOTH, TAN MOTTLES	A	NF	250	SF
M-MAS-23	MASTIC, YELLOW, TACKY, ASSOCIATED WITH VINYL COMPOSITION TILE, 12"X12", OFF-WHITE, SMOOTH, WHITE MOTTLES AND VINYL COMPOSITION TILE, 12"X12", TAN, SMOOTH, TAN MOTTLES	A	NF	500	SF

END OF TABLE

2.7 Physical Assessments

A physical assessment of each identified HA of suspect ACBM was conducted to determine what, if any, damage the area has sustained and to determine whether the material should be classified as either friable or non-friable.

The EPA defines a friable material to be one which, when dry, can be crumbled, pulverized, or reduced to powder by hand pressure. Based on this definition of friability, FM ascertained if a material was friable by physically touching each material surface.

At the time of this inspection, **SIX** friable suspect ACBM (acoustical ceiling panels and duct seam tape) were observed. Since **TWO** of these materials were assumed to contain asbestos, **TWO** formal assessments are included in this report.

2.8 Sample Collection

Convenience sampling was performed on select identified suspect ACBM. Destructive sampling activities to access materials within ceiling, floor or wall systems were not utilized. Inspection personnel performing sampling activities utilized proper personnel protection. Additionally, inspection procedures included the use of engineering controls to minimize the release of airborne fibers during sample collection.

Based on FM's sampling strategy, the following number of bulk-material samples was collected from observed suspect ACBM.

<i>Building</i>	<i>Suspect ACBM</i>	<i>Samples Collected</i>
Main	77 (31 Assumed)	138
Portable P71/72	22 (1 Assumed)	3
Portable P73/74	22 (1 Assumed)	3
<i>TOTAL</i>	<i>121</i>	<i>144</i>

Suspect ACM Designation and Sample Record Forms are presented in Appendix A.

2.9 Bulk-Material Sample Analysis

Upon completion of the on-site portion of the work, bulk-material samples accompanied by a Chain-of-Custody form were delivered to FAS for analysis. Samples were analyzed using PLM coupled with dispersion staining as detailed in the EPA's "Interim Method for the Determination of Asbestos Material Insulation Samples" (EPA-66/M4-82-020, December 1982).

Report of Findings

Comprehensive AHERA Asbestos Inspection
Kyrene De La Esperanza Elementary School, KSD
FM Project 08-085

PLM is the EPA recommended method for bulk sample analysis and utilizes the unique optical and crystallographic properties of the various constituents of the sample for material identification purposes. These properties, refractive indices, birefringence, sign of elongation, and extinction angle, are characteristically unique to each asbestos form and were used to identify asbestos types present in the samples. Under existing EPA guidelines, the identification of asbestos-form minerals in a single bulk-material sample is sufficient to classify that material as an ACM. On the other hand, a *minimum* of three samples must be identified as not containing asbestos-form minerals to classify that material as non-ACM. All samples of a specific suspect ACM were analyzed until the first sample containing an asbestos-form mineral was found.

Bulk-Material Sample Documentation is presented in Appendix C. These forms identify the samples analytically tested by the laboratory. These laboratory records denote layer identification and material composition by sample percentage.

END OF REPORT

APPENDIX A

Suspect Asbestos-Containing Material Designation and Sample Record Forms

Project No.: 08-085 Project Name: AHERA Compliance Inspection Owner: Kyrene School District No. 28
 Building No.: Main Building Address: 14841 S. 41st place
 Campus Name: Kyrene de la Esperanza Phoenix, AZ 85044

Material Code: M-CMMA-01 Damaged: Yes No Friable: Non-Friable:
 General Description: CONCRETE MASONRY WORK Size: 4" x 4"

Matrix/Primary Color: GRAY Texture/Pattern: CEMENTIOUS Cover/Secondary Color: N/A
 Quantity of Material: 8000 Estimated By: Drawing Field Measure Sampled Assumed

Homogeneous Material Location: Ceiling Floor Wall Other
 Manner of Sampling: Random Convenience N/A

Sample ID	Sample Location	Points of Origin	East/West Direction	North/South Direction	Height A.F.F.	Surface
A	Exterior	NW Corner	E 0'	S 180'	3'	F/W/C/O
B		NW Corner	E 2'	S 0'	4'	F/W/C/O
C		NE Corner	W 0'	S 150'	4'	F/W/C/O
D		Corner				F/W/C/O
E		Corner				F/W/C/O
F		Corner				F/W/C/O
G		Corner				F/W/C/O

Comments: _____

Inspector: Dane Thompson Inspector: Michael Richter
 AHERA Certificate No.: D9953 State License: EPA AHERA Certificate No.: D10790 State License: EPA
 Signature: *[Signature]* Date: 03/06/08 Signature: *[Signature]* Date: 03/06/08

Asbestos-Containing Material: No Yes

SUSPECT ASBESTOS-CONTAINING MATERIAL DESIGNATION AND SAMPLE RECORD FORM



15974 N. 77th Street
 Scottsdale, AZ 85260
 (602) 277-7877
 (602) 277-9288 fax

FM GROUP/forms/SuspACMDesigRecord.oft

Project No.: 08-085 Project Name: AHERA Compliance Inspection Owner: Kyrene School District No. 28
 Building No.: Main Building Address: 14841 S. 41st place
 Campus Name: Kyrene de la Esperanza Phoenix, AZ 85044

Material Code: M-CMU-DZ Damaged: Yes No Friable Non-Friable
 General Description: CONCRETE MASONRY UNIT Size: 4" x 16"

Matrix/Primary Color: RED Texture/Pattern: HETEROGENEOUS Cover/Secondary Color: N/A
 Quantity of Material: 10,000 Estimated By: Drawing Assumed
 Field Measure

Homogeneous Material Location: Ceiling Floor Wall Other
 Manner of Sampling: Random Convenience N/A

Sample ID	Sample Location	Points of Origin	East/West Direction	North/South Direction	Height A.F.F.	Surface
A	Exterior	NW Corner	E 0'	S 180'	3'	F/W/C/O
B	L	NW Corner	E 2'	S 0'	4'	F/W/C/O
C	L	NE Corner	W 0'	S 150'	4'	F/W/C/O
D		Corner				F/W/C/O
E		Corner				F/W/C/O
F		Corner				F/W/C/O
G		Corner				F/W/C/O

Comments:

Inspector: Dane Thompson Inspector: Michael Richter
 AHERA Certificate No.: D9953 State License: EPA D10790 State License: EPA
 Signature: CR Signature: [Signature] Date: 03/06/08 Date: 03/06/08

Asbestos-Containing Material: No Yes

SUSPECT ASBESTOS-CONTAINING MATERIAL DESIGNATION AND SAMPLE RECORD FORM



15974 N. 77th Street
 Scottsdale, AZ 85260
 (602) 277-7877
 (602) 277-8288 fax

Project No.: 08-085 Project Name: AHERA Compliance Inspection Owner: Kyrene School District No. 28
 Building No.: Main Building Address: 14841 S. 41st place
 Campus Name: Kyrene de la Esperanza Phoenix, AZ 85044

Material Code: M-CMCL-03 Damaged: Yes No Friable Non-Friable
 General Description: CONCRETE MASSIVE UNIK Size: 8" X 16"

Matrix/Primary Color: GRAY Texture/Pattern: CEMENTITIOUS Cover/Secondary Color: TEXTURED
 Quantity of Material: 3000 Estimated By: Drawing Sampled Assumed
 Field Measure

Homogeneous Material Location: Ceiling Floor Wall Other
 Manner of Sampling: Random Convenience N/A

Sample ID	Sample Location	Points of Origin	East/West Direction	North/South Direction	Height A.F.F.	Surface
A	Exterior	NW Corner	E 0'	S 180'	3'	F/W/C/O
B		NW Corner	E 2'	S 0'	4'	F/W/C/O
C		NE Corner	W 0'	S 150'	4'	F/W/C/O
D		Corner				F/W/C/O
E		Corner				F/W/C/O
F		Corner				F/W/C/O
G		Corner				F/W/C/O

Comments: _____

Inspector: Dane Thompson Inspector: Michael Richter
 AHERA Certificate No.: D9953 State License: EPA AHERA Certificate No.: D10790 State License: EPA
 Signature: [Signature] Date: 03/06/08 Signature: [Signature] Date: 03/06/08

Asbestos-Containing Material: No Yes

SUSPECT ASBESTOS-CONTAINING MATERIAL DESIGNATION AND SAMPLE RECORD FORM

15974 N. 77th Street
 Scottsdale, AZ 85260
 (602) 277-7877
 (602) 277-8288 fax

FM GROUP/Forms/SuspACMDesigRecordL.mf

Project No.: 08-085 Project Name: AHERA Compliance Inspection Owner: Kyrene School District No. 28
 Building No.: Main Building Address: 14841 S. 41st place
 Campus Name: Kyrene de la Esperanza Phoenix, AZ 85044

Material Code: MCMU-04 Damaged: Yes No Friable Non-Friable
 General Description: CONCRETE MASONRY WALL Size: 8" x 16"

Matrix/Primary Color: GRAY Texture/Pattern: CEMENTITIOUS Cover/Secondary Color: 8" x 8" PATTERN
 Quantity of Material: 3000 Estimated By: Drawing Sampled Assumed
 Homogeneous Material Location: Ceiling Floor Wall Other

Manner of Sampling: Random Convenience N/A

Sample ID	Sample Location	Points of Origin	East/West Direction	North/South Direction	Height A.F.F.	Surface
A	Exterior	NW Corner	E 0'	S 180'	3'	F/W/C/O
B		NW Corner	E 2'	S 0'	4'	F/W/C/O
C		NE Corner	W 0'	S 150'	4'	F/W/C/O
D		Corner				F/W/C/O
E		Corner				F/W/C/O
F		Corner				F/W/C/O
G		Corner				F/W/C/O

Comments: _____

Inspector: Dane Thompson Inspector: Michael Richter
 AHERA Certificate No.: D9953 State License: EPA AHERA Certificate No.: D10790 State License: EPA
 Signature: [Signature] Date: 03/06/08 Signature: [Signature] Date: 03/06/08

Asbestos-Containing Material: No Yes

SUSPECT ASBESTOS-CONTAINING MATERIAL DESIGNATION AND SAMPLE RECORD FORM



15974 N. 77th Street
 Scottsdale, AZ 85260
 (602) 277-7877
 (602) 277-8288 fax

FM GROUP/forms/SuspACMDesignRecord1.omf

Project No.: 08-085 Project Name: AHERA Compliance Inspection Owner: Kyrene School District No. 28
 Building No.: Main Building Address: 14841 S. 41st place
 Campus Name: Kyrene de la Esperanza Phoenix, AZ 85044

Material Code: MMRT05 Damaged: Yes No Friable Non-Friable
 Visible Covered
 General Description: MORTAR Size: N/A

Matrix/Primary Color: GRAY Texture/Pattern: CEMENTITIOUS Cover/Secondary Color: N/A
 Quantity of Material: 2,000 Estimated By: Drawing Field Measure

Homogeneous Material Location: Ceiling Floor Wall Other

Manner of Sampling: Random Convenience N/A

Sample ID	Sample Location	Points of Origin	East/West Direction	North/South Direction	Height A.F.F.	Surface
A	Exterior	NW Corner	E 0'	S 180'	3'	F/W/C/O
B		NW Corner	E 2'	S 0'	4'	F/W/C/O
C		NE Corner	W 0'	S 150'	4'	F/W/C/O
D		Corner				F/W/C/O
E		Corner				F/W/C/O
F		Corner				F/W/C/O
G		Corner				F/W/C/O

Comments: ASSOCIATED WITH M.CMU.01, M.CMU.02, M.CMU.03, M.CMU.04

Inspector: Dane Thompson Inspector: Michael Richter
 AHERA Certificate No.: D9953 State License: EPA AHERA Certificate No.: D10790 State License: EPA
 Signature: [Signature] Date: 03/06/08 Signature: [Signature] Date: 03/06/08

Asbestos-Containing Material: No Yes

SUSPECT ASBESTOS-CONTAINING MATERIAL DESIGNATION AND SAMPLE RECORD FORM



15974 N. 77th Street
 Scottsdale, AZ 85260
 (602) 277-7877
 (602) 277-8288 fax

Project No.: 08-085 Project Name: AHERA Compliance Inspection Owner: Kyrene School District No. 28
 Building No.: Main Building Address: 14841 S. 41st place
 Campus Name: Kyrene de la Esperanza Phoenix, AZ 85044

Material Code: M-5LT-00 Damaged: Yes No Friable Friable Non-Friable
 General Description: SEALANT (EXPANSION) Visible Covered Size: N/A

Matrix/Primary Color: GRAY Texture/Pattern: FRIABLE Cover/Secondary Color: N/A
 Quantity of Material: 80 Estimated By: Drawing Sampled Assumed
 Field Measure

Homogeneous Material Location: Ceiling Floor Wall Other

Manner of Sampling: Random Convenience N/A

Sample ID	Sample Location	Points of Origin	East/West Direction	North/South Direction	Height A.F.F.	Surface
A	Exterior	NW Corner	E 0'	S 180'	3'	F / W / C / O
B		NW Corner	E 2'	S 0'	4'	F / W / C / O
C		NE Corner	W 0'	S 150'	4'	F / W / C / O
D		Corner				F / W / C / O
E		Corner				F / W / C / O
F		Corner				F / W / C / O
G		Corner				F / W / C / O

Comments: _____

Inspector: Dane Thompson Inspector: Michael Richter
 AHERA Certificate No.: D9953 State License: EPA AHERA Certificate No.: D10790 State License: EPA
 Signature: [Signature] Date: 03/06/08 Signature: [Signature] Date: 03/06/08

Asbestos-Containing Material: No Yes

SUSPECT ASBESTOS-CONTAINING MATERIAL DESIGNATION AND SAMPLE RECORD FORM

 15974 N. 77th Street
 Scottsdale, AZ 85260
 (602) 277-7877
 (602) 277-8288 fax

Project No.: 08-085 Project Name: AHERA Compliance Inspection Owner: Kyrene School District No. 28
 Building No.: Main Building Address: 14841 S. 41st place
 Campus Name: Kyrene de la Esperanza Phoenix, AZ 85044

Material Code: M-DPT-07 Damaged: Yes No Friable Non-Friable
 General Description: QUARRY / PAPER TILE Size: 8" x 8"

Matrix/Primary Color: RED Texture/Pattern: SMOOTH Cover/Secondary Color: N/A
 Quantity of Material: 13 Estimated By: Drawing Field Measure
 Homogeneous Material Location: Ceiling Floor Wall Other

Manner of Sampling: Random Convenience N/A

Sample ID	Sample Location	Points of Origin	East/West Direction	North/South Direction	Height A.F.F.	Surface
A		Corner				F / W / C / O
B		Corner				F / W / C / O
C		Corner				F / W / C / O
D		Corner				F / W / C / O
E		Corner				F / W / C / O
F		Corner				F / W / C / O
G		Corner				F / W / C / O

Comments:

Inspector: Dane Thompson Inspector: Michael Richter
 AHERA Certificate No.: D9953 State License: EPA AHERA Certificate No.: D10790 State License: EPA
 Signature: *DM* Date: 03/06/08 Signature: *[Signature]* Date: 03/06/08

Asbestos-Containing Material: No Yes ASSUMED

SUSPECT ASBESTOS-CONTAINING MATERIAL DESIGNATION AND SAMPLE RECORD FORM



15974 N. 77th Street
 Scottsdale, AZ 85260
 (602) 277-7877
 (602) 277-8288 fax

Project No.: 08-085 Project Name: AHERA Compliance Inspection Owner: Kyrene School District No. 28
 Building No.: Main Building Address: 14841 S. 41st place
 Campus Name: Kyrene de la Esperanza Phoenix, AZ 85044

Material Code: M.MRT-08 Damaged: Yes No Friable Non-Friable
 General Description: NO STAR Visible Covered Size: N/A

Matrix/Primary Color: WHITE Texture/Pattern: CEMENTITIOUS Cover/Secondary Color: N/A
 Quantity of Material: 50 Estimated By: Drawing Sampled Assumed
 SE / LF / EA Drawing Field Measure

Homogeneous Material Location: Ceiling Floor Wall Other
 Manner of Sampling: Random Convenience N/A

Sample ID	Sample Location	Points of Origin	East/West Direction	North/South Direction	Height A.F.F.	Surface
A	Exterior	NW Corner	E 0'	S 200'	3'	F / W / C / O
B		NE Corner	W 30'	S 220'	3'	F / W / C / O
C		SW Corner	E 80'	N 30'	3'	F / W / C / O
D		Corner				F / W / C / O
E		Corner				F / W / C / O
F		Corner				F / W / C / O
G		Corner				F / W / C / O

Comments: ASSOCIATED WITH GLASS BLOCK, 8"X8", RIBBED

Inspector: Dane Thompson Inspector: Michael Richter
 AHERA Certificate No.: D9953 State License: EPA D10790 State License: EPA
 Signature: [Signature] Signature: [Signature] Date: 03/06/08 Date: 03/06/08

Asbestos-Containing Material: No Yes

SUSPECT ASBESTOS-CONTAINING MATERIAL DESIGNATION AND SAMPLE RECORD FORM

 16974 N. 77th Street
 Scottsdale, AZ 85260
 (602) 277-7877
 (602) 277-8288 fax

FM GROUP/forms/SuspACMDesignRecord.oft

Project No.: 08-085 Project Name: AHERA Compliance Inspection Owner: Kyrene School District No. 28
 Building No.: Main Building Address: 14841 S. 41st place
 Campus Name: Kyrene de la Esperanza Phoenix, AZ 85044

Material Code: M-SLT-09 Damaged: Yes No Friable Non-Friable
 General Description: SEALANT (DOORS, WINDOWS) Visible Covered Size: N/A

Matrix/Primary Color: WHITE Texture/Pattern: PUABLE Cover/Secondary Color: N/A
 Quantity of Material: 40 Estimated By: Drawing Field Measure Sampled Assumed
 Homogeneous Material Location: Ceiling Floor Wall Other

Manner of Sampling: Random Convenience N/A

Sample ID	Sample Location	Points of Origin	East/West Direction	North/South Direction	Height A.F.F.	Surface
A	Exterior	NW Corner	E 0'	S 200'	3'	F / W / C / O
B		NE Corner	W 30'	S 220'	3'	F / W / C / O
C		SW Corner	E 80'	N 30'	3'	F / W / C / O
D		Corner				F / W / C / O
E		Corner				F / W / C / O
F		Corner				F / W / C / O
G		Corner				F / W / C / O

Comments: _____

Inspector: Dane Thompson Inspector: Michael Richter
 AHERA Certificate No.: D9953 State License: EPA AHERA Certificate No.: D10790 State License: EPA
 Signature: [Signature] Date: 03/06/08 Signature: [Signature] Date: 03/06/08

Asbestos-Containing Material: No Yes

SUSPECT ASBESTOS-CONTAINING MATERIAL DESIGNATION AND SAMPLE RECORD FORM



15974 N. 77th Street
 Scottsdale, AZ 85260
 (602) 277-7877
 (602) 277-8288 fax

FM GROUP/forms/SuspACMDesigRecord.omf

Project No.: 08-085 Project Name: AHERA Compliance Inspection Owner: Kyrene School District No. 28
 Building No.: Main Building Address: 14841 S. 41st place
 Campus Name: Kyrene de la Esperanza Phoenix, AZ 85044

Material Code: M-GWT-10 Damaged: Yes No Friable Non-Friable
 General Description: GLAZED WALL TILE Size: 8" X 8"

Matrix/Primary Color: WHITE Texture/Pattern: SMOKY Cover/Secondary Color: MULTICOLORED
 Quantity of Material: 120 Estimated By: Drawing Sampled Assumed
 Homogeneous Material Location: Ceiling Floor Wall Other

Manner of Sampling: Random Convenience N/A

Sample ID	Sample Location	Points of Origin	East/West Direction	North/South Direction	Height A.F.F.	Surface
A		Corner				F / W / C / O
B		Corner				F / W / C / O
C		Corner				F / W / C / O
D		Corner				F / W / C / O
E		Corner				F / W / C / O
F		Corner				F / W / C / O
G		Corner				F / W / C / O

Comments: HAND PAINTED DESIGNS

Inspector: Dane Thompson Inspector: Michael Richter
 AHERA Certificate No.: D9953 State License: EPA AHERA Certificate No.: D10790 State License: EPA
 Signature: [Signature] Date: 03/06/08 Signature: [Signature] Date: 03/06/08

Asbestos-Containing Material: No Yes ASSUMED

SUSPECT ASBESTOS-CONTAINING MATERIAL DESIGNATION AND SAMPLE RECORD FORM



15974 N. 77th Street
 Scottsdale, AZ 85260
 (602) 277-7877
 (602) 277-8288 fax

Project No.: 08-085 Project Name: AHERA Compliance Inspection Owner: Kyrene School District No. 28
 Building No.: Main Building Address: 14841 S. 41st place
 Campus Name: Kyrene de la Esperanza Phoenix, AZ 85044

Material Code: M.G.R.T.11 Damaged: Yes No Friable Non-Friable
 General Description: GRAY Visible Covered Size: N/A

Matrix/Primary Color: GRAY Texture/Pattern: GRANULAR Cover/Secondary Color: N/A
 Quantity of Material: 12 Estimated By: Drawing Field Measure Sampled Assumed

Homogeneous Material Location: Ceiling Floor Wall Other
 Manner of Sampling: Random Convenience N/A

Sample ID	Sample Location	Points of Origin	East/West Direction	North/South Direction	Height A.F.F.	Surface
A		Corner				F / W / C / O
B		Corner				F / W / C / O
C		Corner				F / W / C / O
D		Corner				F / W / C / O
E		Corner				F / W / C / O
F		Corner				F / W / C / O
G		Corner				F / W / C / O

Comments: ASSOCIATED WITH M-GWT-10

Inspector: Dane Thompson Inspector: Michael Richter
 AHERA Certificate No.: D9953 State License: EPA AHERA Certificate No.: D10790 State License: EPA
 Signature: [Signature] Date: 03/06/08 Signature: [Signature] Date: 03/06/08

Asbestos-Containing Material: No Yes ASSUMED

SUSPECT ASBESTOS-CONTAINING MATERIAL DESIGNATION AND SAMPLE RECORD FORM

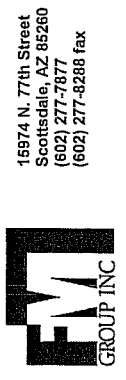

16974 N. 77th Street
 Scottsdale, AZ 85260
 (602) 277-7877
 (602) 277-8288 fax

Project No.: 08-085 Project Name: AHERA Compliance Inspection Owner: Kyrene School District No. 28
 Building No.: Main Building Address: 14841 S. 41st place
 Campus Name: Kyrene de la Esperanza Phoenix, AZ 85044

Material Code: M-CON-12 Damaged: Yes No Friable Non-Friable
 General Description: CONCRETE CENTRIES Size: N/A

Matrix/Primary Color: GRAY Texture/Pattern: CEMENTITIOUS Cover/Secondary Color: N/A
 Quantity of Material: 25,000 Estimated By: Drawing Field Measure
 Sampled Assumed

Homogeneous Material Location: Ceiling Floor Wall Other
 Manner of Sampling: Random Convenience N/A

Sample ID	Sample Location	Points of Origin	East/West Direction	North/South Direction	Height A.F.F.	Surface
A	Exterior	NW Corner	E 0'	S 180'	0'	F/W/C/O
B		NW Corner	E 0'	S 10'	0'	F/W/C/O
C		NE Corner	W 0'	S 150'	0'	F/W/C/O
D		Corner				F/W/C/O
E		Corner				F/W/C/O
F		Corner				F/W/C/O
G		Corner				F/W/C/O

Comments:

Inspector: Dane Thompson Inspector: Michael Richter
 AHERA Certificate No.: D9953 State License: EPA D10790 State License: EPA
 Signature: [Signature] Date: 03/06/08 Signature: [Signature] Date: 03/06/08

Asbestos-Containing Material: No Yes

SUSPECT ASBESTOS-CONTAINING MATERIAL DESIGNATION AND SAMPLE RECORD FORM

 15974 N. 77th Street
 Scottsdale, AZ 85260
 (602) 277-7877
 (602) 277-8288 fax

FM GROUP/forms/SuspACMDesignRecord.omf

Project No.: 08-085 Project Name: AHERA Compliance Inspection Owner: Kyrene School District No. 28
 Building No.: Main Building Address: 14841 S. 41st place
 Campus Name: Kyrene de la Esperanza Phoenix, AZ 85044

Material Code: MCDN-13 Damaged: Yes No Friable Non-Friable
 General Description: CONCRETE (FOUNDATION) Size: N/A

Matrix/Primary Color: GRAY Texture/Pattern: CEMENT/TROUS Cover/Secondary Color: N/A
 Quantity of Material: 60,000 Estimated By: Drawing Field Measure Sampled Assumed

Homogeneous Material Location: Ceiling Floor Wall Other

Manner of Sampling: Random Convenience N/A

Sample ID	Sample Location	Points of Origin	East/West Direction	North/South Direction	Height A.F.F.	Surface
A	Exterior	NW Corner	E 0'	S 120'	0'	F W / C / O
B		NW Corner	E 80'	S 0'	0'	F W / C / O
C		SE Corner	W 0'	N 0'	0'	F W / C / O
D		Corner				F / W / C / O
E		Corner				F / W / C / O
F		Corner				F / W / C / O
G		Corner				F / W / C / O

Comments: _____

Inspector: Dane Thompson Inspector: Michael Richter
 AHERA Certificate No.: D9953 State License: EPA AHERA Certificate No.: D10790 State License: EPA
 Signature: [Signature] Date: 03/06/08 Signature: [Signature] Date: 03/06/08

Asbestos-Containing Material: No Yes

SUSPECT ASBESTOS-CONTAINING MATERIAL DESIGNATION AND SAMPLE RECORD FORM



15974 N. 77th Street
 Scottsdale, AZ 85260
 (602) 277-7877
 (602) 277-8288 fax

Project No.: 08-085 Project Name: AHERA Compliance Inspection Owner: Kyrene School District No. 28
 Building No.: Main Building Address: 14841 S. 41st place
 Campus Name: Kyrene de la Esperanza Phoenix, AZ 85044

Material Code: M-CON-1A Damaged: Yes No Friable Non-Friable
 General Description: CONCRETE (EQUIPMENT PAD) Visible Covered Size: N/A

Matrix/Primary Color: GRAY Texture/Pattern: CEMENTITIOUS Cover/Secondary Color: N/A
 Quantity of Material: 1000 Estimated By: Drawing Field Measure Sampled Assumed
 Homogeneous Material Location: Ceiling Floor Wall Other

Manner of Sampling: Random Convenience N/A

Sample ID	Sample Location	Points of Origin	East/West Direction	North/South Direction	Height A.F.F.	Surface
A		Corner				F / W / C / O
B		Corner				F / W / C / O
C		Corner				F / W / C / O
D		Corner				F / W / C / O
E		Corner				F / W / C / O
F		Corner				F / W / C / O
G		Corner				F / W / C / O

Comments: _____

Inspector: Dane Thompson Inspector: Michael Richter
 AHERA Certificate No.: D9953 State License: EPA AHERA Certificate No.: D10790 State License: EPA
 Signature: [Signature] Date: 03/06/08 Signature: [Signature] Date: 03/06/08

Asbestos-Containing Material: No Yes ASSUMED

SUSPECT ASBESTOS-CONTAINING MATERIAL DESIGNATION AND SAMPLE RECORD FORM



15974 N. 77th Street
 Scottsdale, AZ 85260
 (602) 277-7877
 (602) 277-8288 fax

FM GROUP/forms/SuspACMDesigRecord.omf

Project No.: 08-085 Project Name: AHERA Compliance Inspection Owner: Kyrene School District No. 28
 Building No.: Main Building Address: 14841 S. 41st place
 Campus Name: Kyrene de la Esperanza Phoenix, AZ 85044

Material Code: M-CMU-15 Damaged: Yes No Friable Non-Friable
 General Description: CONCRETE MASONRY UNIT Size: 8"x16"

Matrix/Primary Color: GRAY Texture/Pattern: CEMENTITIOUS Cover/Secondary Color: TEXTURED
 Quantity of Material: 1500 Estimated By: Drawing Sampled Assumed
 Field Measure

Homogeneous Material Location: Ceiling Floor Wall Other
 Manner of Sampling: Random Convenience N/A

Sample ID	Sample Location	Points of Origin	East/West Direction	North/South Direction	Height A.F.F.	Surface
A	Exterior	NW Corner	E 0'	S 20'	3'	F/W/C/O
B		SE Corner	W 0'	N 10'	3'	F/W/C/O
C		SW Corner	E 10'	N 0'	3'	F/W/C/O
D		Corner				F/W/C/O
E		Corner				F/W/C/O
F		Corner				F/W/C/O
G		Corner				F/W/C/O

Comments: _____

Inspector: Dane Thompson State License: EPA D9953
 Inspector: Michael Richter State License: EPA D10790
 AHERA Certificate No.: _____ AHERA Certificate No.: _____
 Signature: _____ Date: 03/06/08
 Signature: _____ Date: 03/06/08

Asbestos-Containing Material: No Yes

SUSPECT ASBESTOS-CONTAINING MATERIAL DESIGNATION AND SAMPLE RECORD FORM



15974 N. 77th Street
 Scottsdale, AZ 85260
 (602) 277-7877
 (602) 277-8288 fax

Project No.: 08-085 Project Name: AHERA Compliance Inspection Owner: Kyrene School District No. 28
 Building No.: Main Building Address: 14841 S. 41st place
 Campus Name: Kyrene de la Esperanza Phoenix, AZ 85044

Material Code: M-CM-10 Damaged: Yes No Friable Non-Friable
 General Description: CONCRETE MASONRY UNIT Size: 4"x/6"

Matrix/Primary Color: RED Texture/Pattern: CEMENTITIOUS Cover/Secondary Color: N/A
 Quantity of Material: 1500 Estimated By: Drawing Field Measure Sampled Assumed

Homogeneous Material Location: Ceiling Floor Wall Other
 Manner of Sampling: Random Convenience N/A

Sample ID	Sample Location	Points of Origin	East/West Direction	North/South Direction	Height A.F.F.	Surface
A	Exterior	NW Corner	E 0'	S 20'	3'	F/W/C/O
B		SE Corner	W 0'	N 10'	3'	F/W/C/O
C		SW Corner	E 10'	N 0'	3'	F/W/C/O
D		Corner				F/W/C/O
E		Corner				F/W/C/O
F		Corner				F/W/C/O
G		Corner				F/W/C/O

Comments: _____

Inspector: Dane Thompson Inspector: Michael Richter
 AHERA Certificate No.: D9953 State License: EPA AHERA Certificate No.: D10790 State License: EPA
 Signature: [Signature] Date: 03/06/08 Signature: [Signature] Date: 03/06/08

Asbestos-Containing Material: No Yes

SUSPECT ASBESTOS-CONTAINING MATERIAL DESIGNATION AND SAMPLE RECORD FORM



15974 N. 77th Street
 Scottsdale, AZ 85260
 (602) 277-7877
 (602) 277-8288 fax

Project No.: 08-085 Project Name: AHERA Compliance Inspection Owner: Kyrene School District No. 28
 Building No.: Main Building Address: 14841 S. 41st place
 Campus Name: Kyrene de la Esperanza Phoenix, AZ 85044

Material Code: MAR-17 Damaged: Yes No Friable Non-Friable
 General Description: MORTAR Size: N/A

Matrix/Primary Color: GRAY Texture/Pattern: CEMENTATIONOUS Cover/Secondary Color: N/A
 Quantity of Material: 300 Estimated By: Drawing Field Measure

Homogeneous Material Location: Ceiling Floor Wall Other
 Manner of Sampling: Random Convenience N/A

Sample ID	Sample Location	Points of Origin	East/West Direction	North/South Direction	Height A.F.F.	Surface
A	Exterior	NW Corner	E 0'	S 20'	3'	F/W/C/O
B	I	SE Corner	W 0'	N 10'	3'	F/W/C/O
C	I	SW Corner	E 10'	N 0'	3'	F/W/C/O
D		Corner				F/W/C/O
E		Corner				F/W/C/O
F		Corner				F/W/C/O
G		Corner				F/W/C/O

Comments: ASBESTATED WITH M.CMU-15, M.CMU-10

Inspector: Dane Thompson Inspector: Michael Richter
 AHERA Certificate No.: D9953 State License: EPA AHERA Certificate No.: D10790 State License: EPA
 Signature: [Signature] Date: 03/06/08 Signature: [Signature] Date: 03/06/08

Asbestos-Containing Material: No Yes

SUSPECT ASBESTOS-CONTAINING MATERIAL DESIGNATION AND SAMPLE RECORD FORM

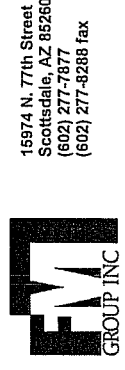

15974 N. 77th Street
 Scottsdale, AZ 85260
 (602) 277-7877
 (602) 277-8288 fax

Project No.: 08-085 Project Name: AHERA Compliance Inspection Owner: Kyrene School District No. 28
 Building No.: Main Building Address: 14841 S. 41st place
 Campus Name: Kyrene de la Esperanza Phoenix, AZ 85044

Material Code: M. BUR-18 Damaged: Yes No Friable Non-Friable
 General Description: BUILT-UP ROOFING Visible Covered Size: N/A

Matrix/Primary Color: BLACK Texture/Pattern: ASPHALTIC Cover/Secondary Color: GRAY MINERAL CAP
 Quantity of Material: 60,000 (SF) / LF / EA Estimated By: Drawing Field Measure Sampled Assumed

Homogeneous Material Location: Ceiling Floor Wall Other

Manner of Sampling: Random Convenience N/A

Sample ID	Sample Location	Points of Origin	East/West Direction	North/South Direction	Height A.F.F.	Surface
A		Corner				F / W / C / O
B		Corner				F / W / C / O
C		Corner				F / W / C / O
D		Corner				F / W / C / O
E		Corner				F / W / C / O
F		Corner				F / W / C / O
G		Corner				F / W / C / O

Comments: SILVER COATINGS

Inspector: Dane Thompson Inspector: Michael Richter
 AHERA Certificate No.: D9953 State License: EPA AHERA Certificate No.: D10790 State License: EPA
 Signature: [Signature] Date: 03/06/08 Signature: [Signature] Date: 03/06/08

Asbestos-Containing Material: No Yes ASSUMED

SUSPECT ASBESTOS-CONTAINING MATERIAL DESIGNATION AND SAMPLE RECORD FORM



16974 N. 77th Street
 Scottsdale, AZ 85260
 (602) 277-7877
 (602) 277-8288 fax

Project No.: 08-085 Project Name: AHERA Compliance Inspection Owner: Kyrene School District No. 28
 Building No.: Main Building Address: 14841 S. 41st place
 Campus Name: Kyrene de la Esperanza Phoenix, AZ 85044

Material Code: 111111 Damaged: Yes No Friable Non-Friable
 General Description: WASTC (PENETRATIONS AND FLASHINGS) Size: N/A
 Matrix/Primary Color: BLACK Cover/Secondary Color: N/A
 Quantity of Material: 100 Estimated By: Drawing Field Measure
 Homogeneous Material Location: Ceiling Floor Wall Other

Manner of Sampling: Random Convenience N/A

Sample ID	Sample Location	Points of Origin	East/West Direction	North/South Direction	Height A.F.F.	Surface
A		Corner				F / W / C / O
B		Corner				F / W / C / O
C		Corner				F / W / C / O
D		Corner				F / W / C / O
E		Corner				F / W / C / O
F		Corner				F / W / C / O
G		Corner				F / W / C / O

Comments: _____

Inspector: Dane Thompson Inspector: Michael Richter
 AHERA Certificate No.: D9953 State License: EPA AHERA Certificate No.: D10790 State License: EPA
 Signature: [Signature] Date: 03/06/08 Signature: [Signature] Date: 03/06/08

Asbestos-Containing Material: No Yes ASSUMED

SUSPECT ASBESTOS-CONTAINING MATERIAL DESIGNATION AND SAMPLE RECORD FORM

15974 N. 77th Street
 Scottsdale, AZ 85260
 (602) 277-7877
 (602) 277-8288 fax



Project No.: 08-085 Project Name: AHERA Compliance Inspection Owner: Kyrene School District No. 28
 Building No.: Main Building Address: 14841 S. 41st place
 Campus Name: Kyrene de la Esperanza Phoenix, AZ 85044

Material Code: 5-TOX-20 Damaged: Yes No Friable Non-Friable
 General Description: TRAWELED - ON TEXTURE (SERVICE AREAS) Size: N/A

Matrix/Primary Color: WHITE Texture/Pattern: CHALKY Cover/Secondary Color: N/A
 Quantity of Material: 900 Estimated By: Drawing Sampled Assumed
 SF / LF / EA Field Measure

Homogeneous Material Location: Ceiling Floor Wall Other

Manner of Sampling: Random Convenience N/A

Sample ID	Sample Location	Points of Origin	East/West Direction	North/South Direction	Height A.F.F.	Surface
A	63A	NW Corner	E 4'	S 0'	3"	F / <u>W</u> / C / O
B	37A	NE Corner	W 0'	S 3'	3"	F / <u>W</u> / C / O
C	Electrical Room 2	SE Corner	W 0'	N 0'	3"	F / <u>W</u> / C / O
D		Corner				F / W / C / O
E		Corner				F / W / C / O
F		Corner				F / W / C / O
G		Corner				F / W / C / O

Comments: _____

Inspector: Dane Thompson Inspector: Michael Richter
 AHERA Certificate No.: D9953 State License: EPA AHERA Certificate No.: D10790 State License: EPA
 Signature: [Signature] Date: 03/06/08 Signature: [Signature] Date: 03/06/08

Asbestos-Containing Material: No Yes

SUSPECT ASBESTOS-CONTAINING MATERIAL DESIGNATION AND SAMPLE RECORD FORM



15974 N. 77th Street
 Scottsdale, AZ 85260
 (602) 277-7877
 (602) 277-8288 fax

FM GROUP/forms/SuspACMDesignRecord.ort

Project No.: 08-085 Project Name: AHERA Compliance Inspection Owner: Kyrene School District No. 28
 Building No.: Main Building Address: 14841 S. 41st place
 Campus Name: Kyrene de la Esperanza Phoenix, AZ 85044

Material Code: M.GWB.21 Damaged: Yes No Friable Non-Friable
 General Description: GYPSUM WALL BOARD Visible Covered Size: 2/A

Matrix/Primary Color: WHITE Texture/Pattern: CHALKY Cover/Secondary Color: N/A
 Quantity of Material: 900 Estimated By: Drawing Sampled Assumed
 Homogeneous Material Location: Ceiling Floor Wall Other Field Measure

Manner of Sampling: Random Convenience N/A

Sample ID	Sample Location	Points of Origin	East/West Direction	North/South Direction	Height A.F.F.	Surface
A	G3A	NW Corner	E 4'	S 0'	3"	F/W/C/O
B	37A	NE Corner	W 0'	S 3'	3"	F/W/C/O
C	Electrical Room 2	SE Corner	W 0'	N 0'	3"	F/W/C/O
D		Corner				F/W/C/O
E		Corner				F/W/C/O
F		Corner				F/W/C/O
G		Corner				F/W/C/O

Comments: ASSOCIATED WITH SATO.20

Inspector: Dane Thompson State License: EPA D9953 Michael Richter State License: EPA D10790
 AHERA Certificate No.: D9953 AHERA Certificate No.: D10790
 Signature: [Signature] Date: 03/06/08 Signature: [Signature] Date: 03/06/08

Asbestos-Containing Material: No Yes

SUSPECT ASBESTOS-CONTAINING MATERIAL DESIGNATION AND SAMPLE RECORD FORM



15974 N. 77th Street
 Scottsdale, AZ 85260
 (602) 277-7877
 (602) 277-8288 fax

Project No.: 08-085 Project Name: AHERA Compliance Inspection Owner: Kyrene School District No. 28
 Building No.: Main Building Address: 14841 S. 41st place
 Campus Name: Kyrene de la Esperanza Phoenix, AZ 85044

Material Code: S-37C-22 Damaged: Yes No Friable Non-Friable
 General Description: Joint Compound Size: N/A
 Matrix/Primary Color: White Texture/Pattern: GALKY Cover/Secondary Color: N/A
 Quantity of Material: 90 Estimated By: Drawing Field Measure
 Homogeneous Material Location: Ceiling Floor Wall Other

Manner of Sampling: Random Convenience N/A

Sample ID	Sample Location	Points of Origin	East/West Direction	North/South Direction	Height A.F.F.	Surface
A	G3A	NW Corner	E 4'	S 0'	3"	F (W) / C / O
B	37A	NE Corner	W 0'	S 3'	3"	F (W) / C / O
C	Electrical Room 2	SE Corner	W 0'	N 0'	3"	F (W) / C / O
D		Corner				F / W / C / O
E		Corner				F / W / C / O
F		Corner				F / W / C / O
G		Corner				F / W / C / O

Comments: ASSOCIATED WITH M.G.W.B.ZI

Inspector: Dane Thompson Inspector: Michael Richter
 AHERA Certificate No.: D9953 State License: EPA AHERA Certificate No.: D10790 State License: EPA
 Signature: [Signature] Date: 03/06/08 Signature: [Signature] Date: 03/06/08

Asbestos-Containing Material: No Yes

SUSPECT ASBESTOS-CONTAINING MATERIAL DESIGNATION AND SAMPLE RECORD FORM



15974 N. 77th Street
 Scottsdale, AZ 85260
 (602) 277-7877
 (602) 277-8288 fax

Project No.: 08-085 Project Name: AHERA Compliance Inspection Owner: Kyrene School District No. 28
 Building No.: Main Building Address: 14841 S. 41st place
 Campus Name: Kyrene de la Esperanza Phoenix, AZ 85044

Material Code: M.V.C.T. 23 Damaged: Yes No Friable Non-Friable
 General Description: VINYL COMPOSITION TILE Size: 12" X 12"

Matrix/Primary Color: TAN Texture/Pattern: SMOOTH Cover/Secondary Color: TAN MOTTLÉS
 Quantity of Material: 25,000 Estimated By: Drawing Sampled Assumed
 Homogeneous Material Location: Ceiling Floor Wall Other

Manner of Sampling: Random Convenience N/A

Sample ID	Sample Location	Points of Origin	East/West Direction	North/South Direction	Height A.F.F.	Surface
A		SW Corner	E 2'	N 8'	0'	F/W/C/O
B		SW Corner	E 6'	N 2'	0'	F/W/C/O
C		SW Corner	E 10'	N 2'	0'	F/W/C/O
D		Corner				F/W/C/O
E		Corner				F/W/C/O
F		Corner				F/W/C/O
G		Corner				F/W/C/O

Comments: _____

Inspector: Dane Thompson Inspector: Michael Richter
 AHERA Certificate No.: D9953 State License: EPA D10790 State License: EPA
 Signature: *DM* Signature: *MR* Date: 03/06/08 Date: 03/06/08

Asbestos-Containing Material: No Yes

SUSPECT ASBESTOS-CONTAINING MATERIAL DESIGNATION AND SAMPLE RECORD FORM



15974 N. 77th Street
 Scottsdale, AZ 85260
 (602) 277-7877
 (602) 277-8288 fax

Project No.: 08-085 Project Name: AHERA Compliance Inspection Owner: Kyrene School District No. 28
 Building No.: Main Building Address: 14841 S. 41st place
 Campus Name: Kyrene de la Esperanza Phoenix, AZ 85044

Material Code: M-MAS-24 Damaged: Yes No Friable Non-Friable
 General Description: MASTIC Visible Covered Size: N/A

Matrix/Primary Color: YELLOW Texture/Pattern: TACKY Cover/Secondary Color: N/A
 Quantity of Material: 75,000 Estimated By: Drawing Sampled Assumed
 LF / EA Field Measure

Homogeneous Material Location: Ceiling Floor Wall Other
 Manner of Sampling: Random Convenience N/A

Sample ID	Sample Location	Points of Origin	East/West Direction	North/South Direction	Height A.F.F.	Surface
A	34	SW Corner	E 2'	N 8'	0'	F/W/C/O
B	18	SW Corner	E 6'	N 2'	0'	F/W/C/O
C	50	SW Corner	E 10'	N 2'	0'	F/W/C/O
D		Corner				F/W/C/O
E		Corner				F/W/C/O
F		Corner				F/W/C/O
G		Corner				F/W/C/O

Comments: ASSOCIATED WITH M.V.C.T. 23, M.V.C.T. 48, M.V.C.T. 61, M.V.C.T. 62, M.V.C.T. 63, M.V.C.T. 64

Inspector: Dane Thompson Inspector: Michael Richter
 AHERA Certificate No.: D9953 State License: EPA AHERA Certificate No.: D10790 State License: EPA
 Signature: [Signature] Date: 03/06/08 Signature: [Signature] Date: 03/06/08

Asbestos-Containing Material: No Yes

SUSPECT ASBESTOS-CONTAINING MATERIAL DESIGNATION AND SAMPLE RECORD FORM

15974 N. 77th Street
 Scottsdale, AZ 85260
 (602) 277-7877
 (602) 277-8286 fax

FM GROUP INC

Project No.: 08-085 Project Name: AHERA Compliance Inspection Owner: Kyrene School District No. 28
 Building No.: Main Building Address: 14841 S. 41st place
 Campus Name: Kyrene de la Esperanza Phoenix, AZ 85044

Material Code: M-WAB-25 Damaged: Yes No Friable Non-Friable
 General Description: WALL BASE (COVERED) Visible Covered Size: 4"

Matrix/Primary Color: BLUE Texture/Pattern: VINYL-LIKE Cover/Secondary Color: N/A
 Quantity of Material: 1500 Estimated By: Drawing Sampled
 Field Measure Assumed

Homogeneous Material Location: Ceiling Floor Wall Other
 Manner of Sampling: Random Convenience N/A

Sample ID	Sample Location	Points of Origin	East/West Direction	North/South Direction	Height A.F.F.	Surface
A	Stage	SE Corner	W 0'	N 3'	3"	F / W / C / O
B	C-10	SE Corner	W 0'	N 0'	3"	F / W / C / O
C	Foyer 2	NE Corner	W 0'	S 0'	3"	F / W / C / O
D		Corner				F / W / C / O
E		Corner				F / W / C / O
F		Corner				F / W / C / O
G		Corner				F / W / C / O

Comments: _____

Inspector: Dane Thompson Inspector: Michael Richter
 AHERA Certificate No.: D9953 State License: EPA D10790 State License: EPA
 Signature: [Signature] Signature: [Signature] Date: 03/06/08 Date: 03/06/08

Asbestos-Containing Material: No Yes

SUSPECT ASBESTOS-CONTAINING MATERIAL DESIGNATION AND SAMPLE RECORD FORM

 15974 N. 77th Street
 Scottsdale, AZ 85260
 (602) 277-7877
 (602) 277-8288 fax

Project No.: 08-085 Project Name: AHERA Compliance Inspection Owner: Kyrene School District No. 28
 Building No.: Main Building Address: 14841 S. 41st place
 Campus Name: Kyrene de la Esperanza Phoenix, AZ 85044

Material Code: M.ADH.26 Damaged: Yes No Friable Non-Friable
 General Description: ADHESIVE Visible Covered WAB Size: N/A

Matrix/Primary Color: CREAM Texture/Pattern: FRIABLE Cover/Secondary Color: N/A
 Quantity of Material: 1500 Estimated By: Drawing Field Measure

Homogeneous Material Location: Ceiling Floor Wall Other

Manner of Sampling: Random Convenience N/A

Sample ID	Sample Location	Points of Origin	East/West Direction	North/South Direction	Height A.F.F.	Surface
A	Stage	SE Corner	W 0'	N 3'	3"	F W / C / O
B	C-10	SE Corner	W 0'	N 0'	3"	F W / C / O
C	Foyer 2	NE Corner	W 0'	S 0'	3"	F W / C / O
D		Corner				F W / C / O
E		Corner				F W / C / O
F		Corner				F W / C / O
G		Corner				F W / C / O

Comments: ASSOCIATED WITH M.WAB.25

Inspector: Dane Thompson Inspector: Michael Richter
 AHERA Certificate No.: D9953 State License: EPA AHERA Certificate No.: D10790 State License: EPA
 Signature: [Signature] Date: 03/06/08 Signature: [Signature] Date: 03/06/08

Asbestos-Containing Material: No Yes

SUSPECT ASBESTOS-CONTAINING MATERIAL DESIGNATION AND SAMPLE RECORD FORM



15974 N. 77th Street
 Scottsdale, AZ 85260
 (602) 277-7877
 (602) 277-8288 fax

Project No.: 08-085 Project Name: AHERA Compliance Inspection Owner: Kyrene School District No. 28
 Building No.: Main Building Address: 14841 S. 41st place
 Campus Name: Kyrene de la Esperanza Phoenix, AZ 85044

Material Code: WFD1.27 Damaged: Yes No Friable Non-Friable
 General Description: FIRE DOOR INSULATION Size: N/A

Matrix/Primary Color: N/A Texture/Pattern: WOOD CLADDING Cover/Secondary Color: N/A
 Quantity of Material: 1806 Estimated By: Drawing Field Measure Sampled Assumed

Homogeneous Material Location: Ceiling Floor Wall Other

Manner of Sampling: Random Convenience N/A

Sample ID	Sample Location	Points of Origin	East/West Direction	North/South Direction	Height A.F.F.	Surface
A		Corner				F / W / C / O
B		Corner				F / W / C / O
C		Corner				F / W / C / O
D		Corner				F / W / C / O
E		Corner				F / W / C / O
F		Corner				F / W / C / O
G		Corner				F / W / C / O

Comments: _____

Inspector: Dane Thompson Inspector: Michael Richter
 AHERA Certificate No.: D9953 State License: EPA AHERA Certificate No.: D10790 State License: EPA
 Signature: [Signature] Date: 03/06/08 Signature: [Signature] Date: 03/06/08

Asbestos-Containing Material: No Yes ASSUMED

SUSPECT ASBESTOS-CONTAINING MATERIAL DESIGNATION AND SAMPLE RECORD FORM



15974 N. 77th Street
 Scottsdale, AZ 85260
 (602) 277-7877
 (602) 277-8288 fax

Project No.: 08-085 Project Name: AHERA Compliance Inspection Owner: Kyrene School District No. 28
 Building No.: Main Building Address: 14841 S. 41st place
 Campus Name: Kyrene de la Esperanza Phoenix, AZ 85044

Material Code: M-PSL28 Damaged: Yes No Friable Non-Friable
 General Description: APE SEALANT Size: N/A

Matrix/Primary Color: Yellow Texture/Pattern: RIABLE Cover/Secondary Color: N/A
 Quantity of Material: 75 Estimated By: Drawing Field Measure Sampled Assumed

Homogeneous Material Location: Ceiling Floor Wall Other

Manner of Sampling: Random Convenience N/A

Sample ID	Sample Location	Points of Origin	East/West Direction	North/South Direction	Height A.F.F.	Surface
A		Corner				F / W / C / O
B		Corner				F / W / C / O
C		Corner				F / W / C / O
D		Corner				F / W / C / O
E		Corner				F / W / C / O
F		Corner				F / W / C / O
G		Corner				F / W / C / O

Comments:

Inspector: Dane Thompson State License: EPA AHERA Certificate No.: D9953 Date: 03/06/08
 Inspector: Michael Richter State License: EPA AHERA Certificate No.: D10790 Date: 03/06/08
 Signature: [Signature] Signature: [Signature]

Asbestos-Containing Material: No Yes ASSUMED

SUSPECT ASBESTOS-CONTAINING MATERIAL DESIGNATION AND SAMPLE RECORD FORM



15974 N. 77th Street
 Scottsdale, AZ 85260
 (602) 277-7877
 (602) 277-8288 fax

Project No.: 08-085 Project Name: AHERA Compliance Inspection Owner: Kyrene School District No. 28
 Building No.: Main Building Address: 14841 S. 41st place
 Campus Name: Kyrene de la Esperanza Phoenix, AZ 85044

Material Code: S-SAF-29 Damaged: Yes No Friable Non-Friable
 General Description: SPRAY-APPLIED TEXTURE (RESTROOMS) Size: N/A

Matrix/Primary Color: WHITE Cover/Secondary Color: N/A
 Quantity of Material: 5000 Texture/Pattern: CHALKY Estimated By: Drawing Sampled Assumed
 Homogeneous Material Location: Ceiling Floor Wall Other

Manner of Sampling: Random Convenience N/A

Sample ID	Sample Location	Points of Origin	East/West Direction	North/South Direction	Height A.F.F.	Surface
A	62-A	SW Corner	E 0'	N 0'	3'	F/W/C/O
B	37-A	NE Corner	W 0'	S 4'	3'	F/W/C/O
C	Janitor 2	SW Corner	E 0'	N 1'	3'	F/W/C/O
D		Corner				F/W/C/O
E		Corner				F/W/C/O
F		Corner				F/W/C/O
G		Corner				F/W/C/O

Comments: _____

Inspector: Dane Thompson State License: EPA AHERA Certificate No.: D9953 Date: 03/06/08
 Inspector: Michael Richter State License: EPA AHERA Certificate No.: D10790 Date: 03/06/08
 Signature: _____ Signature: _____

Asbestos-Containing Material: No Yes

SUSPECT ASBESTOS-CONTAINING MATERIAL DESIGNATION AND SAMPLE RECORD FORM

15974 N. 77th Street
 Scottsdale, AZ 85260
 (602) 277-7877
 (602) 277-8288 fax



FM GROUP/forms/SuspACMDesignRecord.omf

Project No.: 08-085 Project Name: AHERA Compliance Inspection Owner: Kyrene School District No. 28
 Building No.: Main Building Address: 14841 S. 41st place
 Campus Name: Kyrene de la Esperanza Phoenix, AZ 85044

Material Code: M-GWB-30 Damaged: Yes No Friable Non-Friable
 General Description: GYPSUM WALLBOARD Size: N/A

Matrix/Primary Color: WHITE Texture/Pattern: CRACKLY Cover/Secondary Color: N/A
 Quantity of Material: 5000 Estimated By: Drawing Field Measure
 Homogeneous Material Location: Ceiling Floor Wall Other

Manner of Sampling: Random Convenience N/A

Sample ID	Sample Location	Points of Origin	East/West Direction	North/South Direction	Height A.F.F.	Surface
A	G2-A	SW Corner	E 0'	N 0'	3'	F/W/C/O
B	37-A	NE Corner	W 0'	S 4'	3'	F/W/C/O
C	Janitor 2	SW Corner	E 0'	N 1'	3'	F/W/C/O
D		Corner				F/W/C/O
E		Corner				F/W/C/O
F		Corner				F/W/C/O
G		Corner				F/W/C/O

Comments: ASSOCIATED WITH S-SAT-29

Inspector: Dane Thompson Inspector: Michael Richter
 AHERA Certificate No.: D9953 State License: EPA AHERA Certificate No.: D10790 State License: EPA
 Signature: *DM* Date: 03/06/08 Signature: *MR* Date: 03/06/08

Asbestos-Containing Material: No Yes

SUSPECT ASBESTOS-CONTAINING MATERIAL DESIGNATION AND SAMPLE RECORD FORM

15974 N. 77th Street
 Scottsdale, AZ 85260
 (602) 277-7877
 (602) 277-8288 fax



Project No.: 08-085 Project Name: AHERA Compliance Inspection Owner: Kyrene School District No. 28
 Building No.: Main Building Address: 14841 S. 41st place
 Campus Name: Kyrene de la Esperanza Phoenix, AZ 85044

Material Code: S-3TC-31 Damaged: Yes No Friable Non-Friable
 General Description: SOILY COMPOUND Visible Covered SAT Size: N/A

Matrix/Primary Color: WHITE Texture/Pattern: CHALKY Cover/Secondary Color: N/A
 Quantity of Material: 500 Estimated By: Drawing Field Measure

Homogeneous Material Location: Ceiling Floor Wall Other
 Manner of Sampling: Random Convenience N/A

Sample ID	Sample Location	Points of Origin	East/West Direction	North/South Direction	Height A.F.F.	Surface
A	G2-A	SW Corner	E 0'	N 0'	3'	F / W / C / O
B	37-A	NE Corner	W 0'	S 4'	3'	F / W / C / O
C	Janitor 2	SW Corner	E 0'	N 1'	3'	F / W / C / O
D		Corner				F / W / C / O
E		Corner				F / W / C / O
F		Corner				F / W / C / O
G		Corner				F / W / C / O

Comments: ASSOCIATED WITH M-6WB-30

Inspector: Dane Thompson Inspector: Michael Richter
 AHERA Certificate No.: D9953 State License: EPA AHERA Certificate No.: D10790 State License: EPA
 Signature: [Signature] Date: 03/06/08 Signature: [Signature] Date: 03/06/08

Asbestos-Containing Material: No Yes

SUSPECT ASBESTOS-CONTAINING MATERIAL DESIGNATION AND SAMPLE RECORD FORM

15974 N. 77th Street
 Scottsdale, AZ 85260
 (602) 277-7877
 (602) 277-8288 fax

FM GROUP INC

Project No.: 08-085 Project Name: AHERA Compliance Inspection Owner: Kyrene School District No. 28
 Building No.: Main Building Address: 14841 S. 41st place
 Campus Name: Kyrene de la Esperanza Phoenix, AZ 85044

Material Code: M-SLT-3Z Damaged: Yes No Friable Non-Friable
 General Description: SEALANT (DOORS, WINDOWS, MILLWORK, FIXTURES) Size: N/A
 Matrix/Primary Color: WHITE Texture/Pattern: FRIABLE Cover/Secondary Color: N/A
 Quantity of Material: 200 Estimated By: Drawing Sampled Assumed
 Field Measure
 Homogeneous Material Location: Ceiling Floor Wall Other

Manner of Sampling: Random Convenience N/A

Sample ID	Sample Location	Points of Origin	East/West Direction	North/South Direction	Height A.F.F.	Surface
A		NW Corner	E 6'	S 0'	3'	F / W / C / O
B		SW Corner	E 6'	N 0'	3'	F / W / C / O
C	Mens RR	SW Corner	E 0'	N 0'	3'	F / W / C / O
D		Corner				F / W / C / O
E		Corner				F / W / C / O
F		Corner				F / W / C / O
G		Corner				F / W / C / O

Comments: _____

Inspector: Dane Thompson Inspector: Michael Richter
 AHERA Certificate No.: D9953 State License: EPA D10790 State License: EPA
 Signature: *DM* Signature: *MR* Date: 03/06/08 Date: 03/06/08

Asbestos-Containing Material: No Yes

SUSPECT ASBESTOS-CONTAINING MATERIAL DESIGNATION AND SAMPLE RECORD FORM



15974 N. 77th Street
 Scottsdale, AZ 85260
 (602) 277-7877
 (602) 277-8288 fax

FM GROUP/forms/SuspACIMDesignRecord.omf

Project No.: 08-085 Project Name: AHERA Compliance Inspection Owner: Kyrene School District No. 28
 Building No.: Main Building Address: 14841 S. 41st place
 Campus Name: Kyrene de la Esperanza Phoenix, AZ 85044

Material Code: N.C.P. 33 Damaged: Yes No Friable Non-Friable
 General Description: CARPET Size: N/A

Matrix/Primary Color: GRAY Texture/Pattern: FIBROUS Cover/Secondary Color: MULTICOLORED
 Quantity of Material: 35,000 Estimated By: Drawing Field Measure Sampled Assumed

Homogeneous Material Location: Ceiling Floor Wall Other

Manner of Sampling: Random Convenience N/A

Sample ID	Sample Location	Points of Origin	East/West Direction	North/South Direction	Height A.F.F.	Surface
A	Stage	SE Corner	W 0'	N 3'	0'	F / W / C / O
B	C-08	NE Corner	W 12'	S 0'	0'	F / W / C / O
C	C-03	NW Corner	E 0'	S 4'	0'	F / W / C / O
D		Corner				F / W / C / O
E		Corner				F / W / C / O
F		Corner				F / W / C / O
G		Corner				F / W / C / O

Comments: SELF-STICK

Inspector: Dane Thompson Inspector: Michael Richter
 AHERA Certificate No.: D9953 State License: EPA AHERA Certificate No.: D10790 State License: EPA
 Signature: [Signature] Date: 03/06/08 Signature: [Signature] Date: 03/06/08

Asbestos-Containing Material: No Yes

SUSPECT ASBESTOS-CONTAINING MATERIAL DESIGNATION AND SAMPLE RECORD FORM



15974 N. 77th Street
 Scottsdale, AZ 85260
 (602) 277-7877
 (602) 277-9288 fax

Project No.: 08-085 Project Name: AHERA Compliance Inspection Owner: Kyrene School District No. 28
 Building No.: Main Building Address: 14841 S. 41st place
 Campus Name: Kyrene de la Esperanza Phoenix, AZ 85044

Material Code: MAR-35 Damaged: Yes No Friable Non-Friable
 General Description: ACOUSTICAL CEILING PANEL Size: 2'x2'

Matrix/Primary Color: GRAY Texture/Pattern: PINKIES AND FISSURES Cover/Secondary Color: WHITE
 Quantity of Material: 50,000 Estimated By: Drawing Field Measure Sampled Assumed

Homogeneous Material Location: Ceiling Floor Wall Other

Manner of Sampling: Random Convenience N/A

Sample ID	Sample Location	Points of Origin	East/West Direction	North/South Direction	Height A.F.F.	Surface
A	G3-A	SW Corner	E 2'	N 2'	8'	F / W / C / O
B	Nurse 2	NE Corner	W 0'	S 0'	8'	F / W / C / O
C	33	NW Corner	E 4'	S 1'	8'	F / W / C / O
D		Corner				F / W / C / O
E		Corner				F / W / C / O
F		Corner				F / W / C / O
G		Corner				F / W / C / O

Comments: _____

Inspector: Dane Thompson Inspector: Michael Richter
 AHERA Certificate No.: D9953 State License: EPA AHERA Certificate No.: D10790 State License: EPA
 Signature: [Signature] Date: 03/06/08 Signature: [Signature] Date: 03/06/08

Asbestos-Containing Material: No Yes

SUSPECT ASBESTOS-CONTAINING MATERIAL DESIGNATION AND SAMPLE RECORD FORM



15974 N. 77th Street
 Scottsdale, AZ 85260
 (602) 277-7877
 (602) 277-8288 fax

Project No.: 08-085 Project Name: AHERA Compliance Inspection Owner: Kyrene School District No. 28
 Building No.: Main Building Address: 14841 S. 41st place
 Campus Name: Kyrene de la Esperanza Phoenix, AZ 85044

Material Code: S-SAT-36 Damaged: Yes No Friable Non-Friable
 General Description: SPRAY-APPLIED VERMOREL CLASSROOMS OFFICES Size: N/A

Matrix/Primary Color: WHITE Texture/Pattern: CHALKY Cover/Secondary Color: N/A
 Quantity of Material: 50,000 Estimated By: Drawing Field Measure Sampled Assumed

Homogeneous Material Location: Ceiling Floor Wall Other

Manner of Sampling: Random Convenience N/A

Sample ID	Sample Location	Points of Origin	East/West Direction	North/South Direction	Height A.F.F.	Surface
A	Janitor office	NW Corner	E 6'	S 0'	4'	F W / C / O
B	34 A	NW Corner	E 0'	S 1'	3'	F W / C / O
C	Storage 1	NE Corner	W 2'	S 0'	4'	F W / C / O
D		Corner				F W / C / O
E		Corner				F W / C / O
F		Corner				F W / C / O
G		Corner				F W / C / O

Comments:

Inspector: Dane Thompson Inspector: Michael Richter
 AHERA Certificate No.: D9953 State License: EPA AHERA Certificate No.: D10790 State License: EPA
 Signature: [Signature] Date: 03/06/08 Signature: [Signature] Date: 03/06/08

Asbestos-Containing Material: No Yes

SUSPECT ASBESTOS-CONTAINING MATERIAL DESIGNATION AND SAMPLE RECORD FORM



15974 N. 77th Street
 Scottsdale, AZ 85260
 (602) 277-7877
 (602) 277-9288 fax

Project No.: 08-085 Project Name: AHERA Compliance Inspection Owner: Kyrene School District No. 28
 Building No.: Main Building Address: 14841 S. 41st place
 Campus Name: Kyrene de la Esperanza Phoenix, AZ 85044

Material Code: M-GNB-37 Damaged: Yes No Friable Non-Friable
 Visible Covered SAT Size: N/A

General Description: GYPSUM WALLBOARD Texture/Pattern: CRACKY Cover/Secondary Color: N/A
 Matrix/Primary Color: WHITE Estimated By: Drawing Sampled
 Quantity of Material: 50,000 SF / LF / EA Field Measure Assumed

Homogeneous Material Location: Ceiling Floor Wall Other
 Manner of Sampling: Random Convenience N/A

Sample ID	Sample Location	Points of Origin	East/West Direction	North/South Direction	Height A.F.F.	Surface
A	Janitor office	NW Corner	E 6'	S 0'	4'	F / W / C / O
B	34-A	NW Corner	E 0'	S 1'	3'	F / W / C / O
C	Storage 1	NE Corner	W 2'	S 0'	4'	F / W / C / O
D		Corner				F / W / C / O
E		Corner				F / W / C / O
F		Corner				F / W / C / O
G		Corner				F / W / C / O

Comments: ASSOCIATED WITH S: SAT .30

Inspector: Dane Thompson Inspector: Michael Richter
 AHERA Certificate No.: D9953 State License: EPA D10790 State License: EPA
 Signature: [Signature] Signature: [Signature] Date: 03/06/08 Date: 03/06/08

Asbestos-Containing Material: No Yes

SUSPECT ASBESTOS-CONTAINING MATERIAL DESIGNATION AND SAMPLE RECORD FORM

15974 N. 77th Street
 Scottsdale, AZ 85260
 (602) 277-7877
 (602) 277-8288 fax



Project No.: 08-085 Project Name: AHERA Compliance Inspection Owner: Kyrene School District No. 28
 Building No.: Main Building Address: 14841 S. 41st place
 Campus Name: Kyrene de la Esperanza Phoenix, AZ 85044

Material Code: S.YC.38 Damaged: Yes No Friable Non-Friable
 Visible Covered Size: N/A

General Description: JOINT COMPOUND Texture/Pattern: CHALKY Cover/Secondary Color: N/A
 Matrix/Primary Color: WHITE Estimated By: Drawing Sampled
 Quantity of Material: 5000 LF / EA Field Measure Assumed

Homogeneous Material Location: Ceiling Floor Wall Other
 Manner of Sampling: Random Convenience N/A

Sample ID	Sample Location	Points of Origin	East/West Direction	North/South Direction	Height A.F.F.	Surface
A	Janitor office	NW Corner	E 6'	S 0'	4'	F / W / C / O
B	34 A	NW Corner	E 0'	S 1'	3'	F / W / C / O
C	Storage 1	NE Corner	W 2'	S 0'	4'	F / W / C / O
D		Corner				F / W / C / O
E		Corner				F / W / C / O
F		Corner				F / W / C / O
G		Corner				F / W / C / O

Comments: ASSOCIATED WITH MUGWB.37

Inspector: Dane Thompson Inspector: Michael Richter
 AHERA Certificate No.: D9953 State License: EPA AHERA Certificate No.: D10790 State License: EPA
 Signature: [Signature] Date: 03/06/08 Signature: [Signature] Date: 03/06/08

Asbestos-Containing Material: No Yes

SUSPECT ASBESTOS-CONTAINING MATERIAL DESIGNATION AND SAMPLE RECORD FORM

15974 N. 77th Street
 Scottsdale, AZ 85260
 (602) 277-7877
 (602) 277-8288 fax



Project No.: 08-085 Project Name: AHERA Compliance Inspection Owner: Kyrene School District No. 28
 Building No.: Main Building Address: 14841 S. 41st place
 Campus Name: Kyrene de la Esperanza Phoenix, AZ 85044

Material Code: S-SAT-39 Damaged: Yes No Friable Non-Friable
 General Description: SPRAY-APPLIED TEXTURE (CORRIDORS) Size: N/A

Matrix/Primary Color: WHITE Texture/Pattern: CHALKY Cover/Secondary Color: N/A
 Quantity of Material: 20,000 Estimated By: Drawing Field Measure Sampled Assumed

Homogeneous Material Location: Ceiling Floor Wall Other

Manner of Sampling: Random Convenience N/A

Sample ID	Sample Location	Points of Origin	East/West Direction	North/South Direction	Height A.F.F.	Surface
A	Stair	NE Corner	W 0'	S 8'	4'	F / W / C / O
B	C-10	SE Corner	W 0'	N 25'	2'	F / W / C / O
C	C-12	NE Corner	W 25'	S 0'	3"	F / W / C / O
D		Corner				F / W / C / O
E		Corner				F / W / C / O
F		Corner				F / W / C / O
G		Corner				F / W / C / O

Comments:

Inspector: Dane Thompson Inspector: Michael Richter
 AHERA Certificate No.: D9953 State License: EPA AHERA Certificate No.: D10790 State License: EPA
 Signature: [Signature] Date: 03/06/08 Signature: [Signature] Date: 03/06/08

Asbestos-Containing Material: No Yes

SUSPECT ASBESTOS-CONTAINING MATERIAL DESIGNATION AND SAMPLE RECORD FORM



15974 N. 77th Street
 Scottsdale, AZ 85260
 (602) 277-7877
 (602) 277-9288 fax

Project No.: 08-085 Project Name: AHERA Compliance Inspection Owner: Kyrene School District No. 28
 Building No.: Main Building Address: 14841 S. 41st place
 Campus Name: Kyrene de la Esperanza Phoenix, AZ 85044

Material Code: M-GWB-40 Damaged: Yes No Friable Non-Friable
 General Description: Gypsum Wallboard Visible Covered SAT Size: N/A
 Matrix/Primary Color: WHITE Texture/Pattern: CHALKY Cover/Secondary Color: N/A
 Quantity of Material: 20,000 Estimated By: Drawing Field Measure Assumed

Homogeneous Material Location: Ceiling Floor Wall Other
 Manner of Sampling: Random Convenience N/A

Sample ID	Sample Location	Points of Origin	East/West Direction	North/South Direction	Height A.F.F.	Surface
A	Stage	NE Corner	W 0'	S 8'	4'	F (W) / C / O
B	C-10	SE Corner	W 0'	N 25'	2'	F (W) / C / O
C	C-12	NE Corner	W 25'	S 0'	3"	F (W) / C / O
D		Corner				F / W / C / O
E		Corner				F / W / C / O
F		Corner				F / W / C / O
G		Corner				F / W / C / O

Comments: ASSOCIATED WITH SSAT-39

Inspector: Dane Thompson Inspector: Michael Richter
 AHERA Certificate No.: D9953 State License: EPA D10790 State License: EPA
 Signature: CM Signature: [Signature] Date: 03/06/08 Date: 03/06/08

Asbestos-Containing Material: No Yes

SUSPECT ASBESTOS-CONTAINING MATERIAL DESIGNATION AND SAMPLE RECORD FORM



16974 N. 77th Street
 Scottsdale, AZ 85260
 (602) 277-7877
 (602) 277-8288 fax

FM GROUP/forms/SuspACMDesigRecord.0mf

Project No.: 08-085 Project Name: AHERA Compliance Inspection Owner: Kyrene School District No. 28
 Building No.: Main Building Address: 14841 S. 41st place
 Campus Name: Kyrene de la Esperanza Phoenix, AZ 85044

Material Code: S-31C-41 Damaged: Yes No Friable Non-Friable
 General Description: JOINT COMPOUND Size: N/A

Matrix/Primary Color: WHITE Texture/Pattern: CHALKY Cover/Secondary Color: N/A
 Quantity of Material: 2,000 Estimated By: Drawing Field Measure Sampled Assumed

Homogeneous Material Location: Ceiling Floor Wall Other

Manner of Sampling: Random Convenience N/A

Sample ID	Sample Location	Points of Origin	East/West Direction	North/South Direction	Height A.F.F.	Surface
A	Stage	NE Corner	W 0'	S 8'	4'	F / W / C / O
B	C-10	SE Corner	W 0'	N 25'	2'	F / W / C / O
C	C-12	NE Corner	W 25'	S 0'	3"	F / W / C / O
D		Corner				F / W / C / O
E		Corner				F / W / C / O
F		Corner				F / W / C / O
G		Corner				F / W / C / O

Comments: ASSOCIATED WITH M.GWB.40

Inspector: Dane Thompson Inspector: Michael Richter
 AHERA Certificate No.: D9953 State License: EPA AHERA Certificate No.: D10790 State License: EPA
 Signature: *DM* Date: 03/06/08 Signature: *[Signature]* Date: 03/06/08

Asbestos-Containing Material: No Yes

SUSPECT ASBESTOS-CONTAINING MATERIAL DESIGNATION AND SAMPLE RECORD FORM



15974 N. 77th Street
 Scottsdale, AZ 85260
 (602) 277-7877
 (602) 277-8288 fax

Project No.: 08-085 Project Name: AHERA Compliance Inspection Owner: Kyrene School District No. 28
 Building No.: Main Building Address: 14841 S. 41st place
 Campus Name: Kyrene de la Esperanza Phoenix, AZ 85044

Material Code: W.SAC.4Z Damaged: Yes No Friable Non-Friable
 General Description: SINK ACOUSTICAL COATING Size: N/A

Matrix/Primary Color: GRAY Texture/Pattern: ROUGH Cover/Secondary Color: N/A
 Quantity of Material: 88 Estimated By: Drawing Field Measure

Homogeneous Material Location: Ceiling Floor Wall Other

Manner of Sampling: Random Convenience N/A

Sample ID	Sample Location	Points of Origin	East/West Direction	North/South Direction	Height A.F.F.	Surface
A	Staff Lounge	NE Corner	W 0'	S 8'	3'	F / W / C / O
B	12	NE Corner	W 0'	S 8'	3'	F / W / C / O
C	33	NW Corner	E 12'	S 0'	3'	F / W / C / O
D		Corner				F / W / C / O
E		Corner				F / W / C / O
F		Corner				F / W / C / O
G		Corner				F / W / C / O

Comments: _____

Inspector: Dane Thompson Inspector: Michael Richter
 AHERA Certificate No.: D9953 State License: EPA AHERA Certificate No.: D10790 State License: EPA
 Signature: [Signature] Date: 03/06/08 Signature: [Signature] Date: 03/06/08

Asbestos-Containing Material: No Yes

SUSPECT ASBESTOS-CONTAINING MATERIAL DESIGNATION AND SAMPLE RECORD FORM



15974 N. 77th Street
 Scottsdale, AZ 85260
 (602) 277-7877
 (602) 277-8288 fax

Project No.: 08-085 Project Name: AHERA Compliance Inspection Owner: Kyrene School District No. 28
 Building No.: Main Building Address: 14841 S. 41st place
 Campus Name: Kyrene de la Esperanza Phoenix, AZ 85044

Material Code: M. SLT. 43 Damaged: Yes No Friable Non-Friable
 Visible Covered
 General Description: SEALANT (DOORS, WINDOWS, MILLWORK) Size: N/A

Matrix/Primary Color: BLACK Texture/Pattern: GUMMY Cover/Secondary Color: N/A
 Quantity of Material: 52 Estimated By: Drawing Field Measure
 LF / EA

Homogeneous Material Location: Ceiling Floor Wall Other

Manner of Sampling: Random Convenience N/A

Sample ID	Sample Location	Points of Origin	East/West Direction	North/South Direction	Height A.F.F.	Surface
A	C-05	SW Corner	E 1'	N 0'	4'	F / W / C / O
B	C-09	NW Corner	E 1'	S 0'	4'	F / W / C / O
C	C-13	SE Corner	W 0'	N 35'	4'	F / W / C / O
D		Corner				F / W / C / O
E		Corner				F / W / C / O
F		Corner				F / W / C / O
G		Corner				F / W / C / O

Comments: _____

Inspector: Dane Thompson Inspector: Michael Richter
 AHERA Certificate No.: D9953 State License: EPA AHERA Certificate No.: D10790 State License: EPA
 Signature: [Signature] Date: 03/06/08 Signature: [Signature] Date: 03/06/08

Asbestos-Containing Material: No Yes

SUSPECT ASBESTOS-CONTAINING MATERIAL DESIGNATION AND SAMPLE RECORD FORM



15974 N. 77th Street
 Scottsdale, AZ 85260
 (602) 277-7877
 (602) 277-8288 fax

Project No.: 08-085 Project Name: AHERA Compliance Inspection Owner: Kyrene School District No. 28
 Building No.: Main Building Address: 14841 S. 41st place
 Campus Name: Kyrene de la Esperanza Phoenix, AZ 85044

Material Code: MFD1.44 Damaged: Yes No Friable Non-Friable
 General Description: FIRE DOOR INSULATION Size: N/A

Matrix/Primary Color: N/A Texture/Pattern: METAL CLADDING Cover/Secondary Color: N/A
 Quantity of Material: 903 Estimated By: Drawing Field Measure
 Homogeneous Material Location: Ceiling Floor Wall Other

Manner of Sampling: Random Convenience N/A

Sample ID	Sample Location	Points of Origin	East/West Direction	North/South Direction	Height A.F.F.	Surface
A		Corner				F / W / C / O
B		Corner				F / W / C / O
C		Corner				F / W / C / O
D		Corner				F / W / C / O
E		Corner				F / W / C / O
F		Corner				F / W / C / O
G		Corner				F / W / C / O

Comments: _____

Inspector: Dane Thompson Inspector: Michael Richter
 AHERA Certificate No.: D9953 State License: EPA AHERA Certificate No.: D10790 State License: EPA
 Signature: [Signature] Date: 03/06/08 Signature: [Signature] Date: 03/06/08

Asbestos-Containing Material: No Yes ASSUMED

SUSPECT ASBESTOS-CONTAINING MATERIAL DESIGNATION AND SAMPLE RECORD FORM



16974 N. 77th Street
 Scottsdale, AZ 85260
 (602) 277-7877
 (602) 277-8288 fax

FM GROUP/forms/SuspACMDesigRecord.omf

Project No.: 08-085 Project Name: AHERA Compliance Inspection Owner: Kyrene School District No. 28
 Building No.: Main Building Address: 14841 S. 41st place
 Campus Name: Kyrene de la Esperanza Phoenix, AZ 85044

Material Code: M-TWP-45 Damaged: Yes No Friable Non-Friable
 Visible Covered Size: N/A

General Description: TACKABLE WALL PANEL Cover/Secondary Color: VINYL COVER
 Matrix/Primary Color: BROWN Texture/Pattern: FIBROUS
 Quantity of Material: 8000 Estimated By: Drawing Field Measure Sampled Assumed

Homogeneous Material Location: Ceiling Floor Wall Other
 Manner of Sampling: Random Convenience N/A

Sample ID	Sample Location	Points of Origin	East/West Direction	North/South Direction	Height A.F.F.	Surface
A	36	NW Corner	E 0'	S 0'	2'	F/W/C/O
B	23	SE Corner	W 2'	N 0'	2'	F/W/C/O
C	53	NW Corner	E 6'	S 0'	2'	F/W/C/O
D		Corner				F/W/C/O
E		Corner				F/W/C/O
F		Corner				F/W/C/O
G		Corner				F/W/C/O

Comments: _____

Inspector: Dane Thompson Inspector: Michael Richter
 AHERA Certificate No.: D9953 State License: EPA AHERA Certificate No.: D10790 State License: EPA
 Signature: [Signature] Date: 03/06/08 Signature: [Signature] Date: 03/06/08

Asbestos-Containing Material: No Yes

SUSPECT ASBESTOS-CONTAINING MATERIAL DESIGNATION AND SAMPLE RECORD FORM



15974 N. 77th Street
 Scottsdale, AZ 85260
 (602) 277-7877
 (602) 277-8288 fax

Project No.: 08-085 Project Name: AHERA Compliance Inspection Owner: Kyrene School District No. 28
 Building No.: Main Building Address: 14841 S. 41st place
 Campus Name: Kyrene de la Esperanza Phoenix, AZ 85044

Material Code: M-VET-46 Damaged: Yes No Friable Non-Friable
 General Description: VINYL COMPOSITION TILE Size: 24" X 24"

Matrix/Primary Color: BLUE Texture/Pattern: CIRCLE PATTERN Cover/Secondary Color: N/A
 Quantity of Material: 300 Estimated By: Drawing Field Measure

Homogeneous Material Location: Ceiling Floor Wall Other

Manner of Sampling: Random Convenience N/A

Sample ID	Sample Location	Points of Origin	East/West Direction	North/South Direction	Height A.F.F.	Surface
A	C-11	SW Corner	E 0'	N 4'	0'	F/W/C/O
B	C-03	NW Corner	E 5'	S 4'	0'	F/W/C/O
C	C-12	NW Corner	E 5'	S 0'	0'	F/W/C/O
D		Corner				F/W/C/O
E		Corner				F/W/C/O
F		Corner				F/W/C/O
G		Corner				F/W/C/O

Comments:

Inspector: Dane Thompson Inspector: Michael Richter
 AHERA Certificate No.: D9953 State License: EPA AHERA Certificate No.: D10790 State License: EPA
 Signature: [Signature] Date: 03/06/08 Signature: [Signature] Date: 03/06/08

Asbestos-Containing Material: No Yes

SUSPECT ASBESTOS-CONTAINING MATERIAL DESIGNATION AND SAMPLE RECORD FORM



15874 N. 77th Street
 Scottsdale, AZ 85260
 (602) 277-7877
 (602) 277-8288 fax

Project No.: 08-085 Project Name: AHERA Compliance Inspection Owner: Kyrene School District No. 28
 Building No.: Main Building Address: 14841 S. 41st place
 Campus Name: Kyrene de la Esperanza Phoenix, AZ 85044

Material Code: M.MAS.47 Damaged: Yes No Friable Non-Friable
 General Description: ALABASTIC Visible Covered VCT Size: N/A

Matrix/Primary Color: YELLOW Texture/Pattern: VACKY Cover/Secondary Color: N/A
 Quantity of Material: 300 Estimated By: Drawing Sampled Assumed
 Homogeneous Material Location: Ceiling Floor Wall Other

Manner of Sampling: Random Convenience N/A

Sample ID	Sample Location	Points of Origin	East/West Direction	North/South Direction	Height A.F.F.	Surface
A	C-11	SW Corner	E 0'	N 4'	0'	F/W/C/O
B	C-03	NW Corner	E 5'	S 4'	0'	F/W/C/O
C	C-12	NW Corner	E 5'	S 0'	0'	F/W/C/O
D		Corner				F/W/C/O
E		Corner				F/W/C/O
F		Corner				F/W/C/O
G		Corner				F/W/C/O

Comments: ASSOCIATED WITH M.VCT. 46

Inspector: Dane Thompson Inspector: Michael Richter
 AHERA Certificate No.: D9953 State License: EPA AHERA Certificate No.: D10790 State License: EPA
 Signature: [Signature] Date: 03/06/08 Signature: [Signature] Date: 03/06/08

Asbestos-Containing Material: No Yes

SUSPECT ASBESTOS-CONTAINING MATERIAL DESIGNATION AND SAMPLE RECORD FORM



15974 N. 77th Street
 Scottsdale, AZ 85260
 (602) 277-7877
 (602) 277-8288 fax

FM GROUP/forms/SuspACMDesigRecord.oft

Project No.: 08-085 Project Name: AHERA Compliance Inspection Owner: Kyrene School District No. 28
 Building No.: Main Building Address: 14841 S. 41st place
 Campus Name: Kyrene de la Esperanza Phoenix, AZ 85044

Material Code: M-VCT-48 Damaged: Yes No Friable Non-Friable
 General Description: VINYL COMPOSITION TILE (PATTERN) Size: 12"X12"

Matrix/Primary Color: PINK Cover/Secondary Color: TAN MOTILES
 Quantity of Material: 80 Estimated By: Drawing Sampled Assumed
 Texture/Pattern: SMOOTH Estimated By: Drawing Field Measure

Homogeneous Material Location: Ceiling Floor Wall Other
 Manner of Sampling: Random Convenience N/A

Sample ID	Sample Location	Points of Origin	East/West Direction	North/South Direction	Height A.F.F.	Surface
A 34		SW Corner	E 2'	N 8'	0'	F/W/C/O
B 18		SW Corner	E 6'	N 2'	0'	F/W/C/O
C 50		SW Corner	E 10'	N 2'	0'	F/W/C/O
D		Corner				F/W/C/O
E		Corner				F/W/C/O
F		Corner				F/W/C/O
G		Corner				F/W/C/O

Comments: _____

Inspector: Dane Thompson Inspector: Michael Richter
 AHERA Certificate No.: D9953 State License: EPA AHERA Certificate No.: D10790 State License: EPA
 Signature: [Signature] Date: 03/06/08 Signature: [Signature] Date: 03/06/08

Asbestos-Containing Material: No Yes

SUSPECT ASBESTOS-CONTAINING MATERIAL DESIGNATION AND SAMPLE RECORD FORM



15974 N. 77th Street
 Scottsdale, AZ 85260
 (602) 277-7877
 (602) 277-8288 fax

FM GROUP/forms/SuspACMDesigRecord.0mf

Project No.: 08-085 Project Name: AHERA Compliance Inspection Owner: Kyrene School District No. 28
 Building No.: Main Building Address: 14841 S. 41st place
 Campus Name: Kyrene de la Esperanza Phoenix, AZ 85044

Material Code: M1-SLT-49 Damaged: Yes No Friable Non-Friable
 Visible Covered Size: N/A

General Description: SEALANT (DUCT) Texture/Pattern: FRIABLE Cover/Secondary Color: N/A
 Matrix/Primary Color: WHITE Estimated By: Drawing Sampled
 Quantity of Material: 150 LF / EA Field Measure Assumed

Homogeneous Material Location: Ceiling Floor Wall Other
 Manner of Sampling: Random Convenience N/A

Sample ID	Sample Location	Points of Origin	East/West Direction	North/South Direction	Height A.F.F.	Surface
A	Reception	SE Corner	W 8'	N 3'	12'	F / W / C / O
B	59	NW Corner	E 8'	S 4'	12'	F / W / C / O
C	29	NW Corner	E 10'	S 8'	12'	F / W / C / O
D		Corner				F / W / C / O
E		Corner				F / W / C / O
F		Corner				F / W / C / O
G		Corner				F / W / C / O

Comments: _____

Inspector: Dane Thompson Inspector: Michael Richter
 AHERA Certificate No.: D9953 State License: EPA AHERA Certificate No.: D10790 State License: EPA
 Signature: [Signature] Date: 03/06/08 Signature: [Signature] Date: 03/06/08

Asbestos-Containing Material: No Yes

SUSPECT ASBESTOS-CONTAINING MATERIAL DESIGNATION AND SAMPLE RECORD FORM



16974 N. 77th Street
 Scottsdale, AZ 85260
 (602) 277-7877
 (602) 277-8288 fax

Project No.: 08-085 Project Name: AHERA Compliance Inspection Owner: Kyrene School District No. 28
 Building No.: Main Building Address: 14841 S. 41st place
 Campus Name: Kyrene de la Esperanza Phoenix, AZ 85044

Material Code: M.DST.50 Damaged: Yes No Friable Non-Friable
 Visible Covered Size: 4"

General Description: DUCT SEAM TAPE Texture/Pattern: CASVAS-LIKE Cover/Secondary Color: N/A
 Matrix/Primary Color: WHITE Estimated By: Drawing Field Measure
 Quantity of Material: 150

Homogeneous Material Location: Ceiling Floor Wall Other
 Manner of Sampling: Random Convenience N/A

Sample ID	Sample Location	Points of Origin	East/West Direction	North/South Direction	Height A.F.F.	Surface
A	Reception	SE Corner	W 8'	N 3'	12'	F / W / C / O
B	Sq	NW Corner	E 8'	S 4'	12'	F / W / C / O
C	Z9	NW Corner	E 10'	S 8'	12'	F / W / C / O
D		Corner				F / W / C / O
E		Corner				F / W / C / O
F		Corner				F / W / C / O
G		Corner				F / W / C / O

Comments:

Inspector: Dane Thompson State License: EPA D9953
 Inspector: Michael Richter State License: EPA D10790
 AHERA Certificate No.: D9953 AHERA Certificate No.: D10790
 Signature: [Signature] Date: 03/06/08
 Signature: [Signature] Date: 03/06/08

Asbestos-Containing Material: No Yes

SUSPECT ASBESTOS-CONTAINING MATERIAL DESIGNATION AND SAMPLE RECORD FORM



15974 N. 77th Street
 Scottsdale, AZ 85260
 (602) 277-7877
 (602) 277-8288 fax

Project No.: 08-085 Project Name: AHERA Compliance Inspection Owner: Kyrene School District No. 28
 Building No.: Main Building Address: 14841 S. 41st place
 Campus Name: Kyrene de la Esperanza Phoenix, AZ 85044

Material Code: M-GWT-51 Damaged: Yes No Friable Non-Friable
 General Description: GRAZED WALL VICE Size: 4" X 4"

Matrix/Primary Color: TAN Texture/Pattern: SMOOTH Cover/Secondary Color: N/A
 Quantity of Material: 5000 Estimated By: Drawing Field Measure Sampled Assumed
 Homogeneous Material Location: Ceiling Floor Wall Other

Manner of Sampling: Random Convenience N/A

Sample ID	Sample Location	Points of Origin	East/West Direction	North/South Direction	Height A.F.F.	Surface
A		Corner				F / W / C / O
B		Corner				F / W / C / O
C		Corner				F / W / C / O
D		Corner				F / W / C / O
E		Corner				F / W / C / O
F		Corner				F / W / C / O
G		Corner				F / W / C / O

Comments:

Inspector: Dane Thompson Inspector: Michael Richter
 AHERA Certificate No.: D9953 State License: EPA D10790 State License: EPA
 Signature: [Signature] Signature: [Signature] Date: 03/06/08 Date: 03/06/08

Asbestos-Containing Material: No Yes ASSUMED

SUSPECT ASBESTOS-CONTAINING MATERIAL DESIGNATION AND SAMPLE RECORD FORM



15974 N. 77th Street
 Scottsdale, AZ 85260
 (602) 277-7877
 (602) 277-8288 fax

Project No.: 08-085 Project Name: AHERA Compliance Inspection Owner: Kyrene School District No. 28
 Building No.: Main Building Address: 14841 S. 41st place
 Campus Name: Kyrene de la Esperanza Phoenix, AZ 85044

Material Code: 41-GWT-52 Damaged: Yes No Friable Non-Friable
 General Description: GLAZED WALL TILE (PATTERN) Size: 4"X4"

Matrix/Primary Color: BLUE Texture/Pattern: SMOOTH Cover/Secondary Color: N/A
 Quantity of Material: 1000 Estimated By: Drawing Field Measure

Homogeneous Material Location: Ceiling Floor Wall Other

Manner of Sampling: Random Convenience N/A

Sample ID	Sample Location	Points of Origin	East/West Direction	North/South Direction	Height A.F.F.	Surface
A		Corner				F / W / C / O
B		Corner				F / W / C / O
C		Corner				F / W / C / O
D		Corner				F / W / C / O
E		Corner				F / W / C / O
F		Corner				F / W / C / O
G		Corner				F / W / C / O

Comments: _____

Inspector: Dane Thompson Inspector: Michael Richter
 AHERA Certificate No.: D9953 State License: EPA AHERA Certificate No.: D10790 State License: EPA
 Signature: [Signature] Date: 03/06/08 Signature: [Signature] Date: 03/06/08

Asbestos-Containing Material: No Yes ASSUMED

SUSPECT ASBESTOS-CONTAINING MATERIAL DESIGNATION AND SAMPLE RECORD FORM



15974 N. 77th Street
 Scottsdale, AZ 85260
 (602) 277-7877
 (602) 277-8288 fax

Project No.: 08-085 Project Name: AHERA Compliance Inspection Owner: Kyrene School District No. 28
 Building No.: Main Building Address: 14841 S. 41st place
 Campus Name: Kyrene de la Esperanza Phoenix, AZ 85044

Material Code: M.GRT.53 Damaged: Yes No Friable Non-Friable
 General Description: GRUNT Size: N/A

Matrix/Primary Color: GRAY Texture/Pattern: CEMENTATION Cover/Secondary Color: N/A
 Quantity of Material: 600 Estimated By: Drawing Field Measure

Homogeneous Material Location: Ceiling Floor Wall Other
 Manner of Sampling: Random Convenience N/A

Sample ID	Sample Location	Points of Origin	East/West Direction	North/South Direction	Height A.F.F.	Surface
A		Corner				F / W / C / O
B		Corner				F / W / C / O
C		Corner				F / W / C / O
D		Corner				F / W / C / O
E		Corner				F / W / C / O
F		Corner				F / W / C / O
G		Corner				F / W / C / O

Comments: ASSOCIATED WITH M.GRT.52, M.GRT.52

Inspector: Dane Thompson Inspector: Michael Richter
 AHERA Certificate No.: D9953 State License: EPA AHERA Certificate No.: D10790 State License: EPA
 Signature: [Signature] Date: 03/06/08 Signature: [Signature] Date: 03/06/08

Asbestos-Containing Material: No Yes ASSUMED

SUSPECT ASBESTOS-CONTAINING MATERIAL DESIGNATION AND SAMPLE RECORD FORM



15974 N. 77th Street
 Scottsdale, AZ 85260
 (602) 277-7877
 (602) 277-8288 fax

Project No.: 08-085 Project Name: AHERA Compliance Inspection Owner: Kyrene School District No. 28
 Building No.: Main Building Address: 14841 S. 41st place
 Campus Name: Kyrene de la Esperanza Phoenix, AZ 85044

Material Code: MCMV-54 Damaged: Yes No Friable Non-Friable
 General Description: CERAMIC MOSAIC TILE Size: 2'x2'

Matrix/Primary Color: TAN Texture/Pattern: SMOOTH Cover/Secondary Color: PEPPERED
 Quantity of Material: 3200 Estimated By: Drawing Field Measure Sampled Assumed

Homogeneous Material Location: Ceiling Floor Wall Other
 Manner of Sampling: Random Convenience N/A

Sample ID	Sample Location	Points of Origin	East/West Direction	North/South Direction	Height A.F.F.	Surface
A		Corner				F / W / C / O
B		Corner				F / W / C / O
C		Corner				F / W / C / O
D		Corner				F / W / C / O
E		Corner				F / W / C / O
F		Corner				F / W / C / O
G		Corner				F / W / C / O

Comments: _____

Inspector: Dane Thompson Inspector: Michael Richter
 AHERA Certificate No.: D9953 State License: EPA AHERA Certificate No.: D10790 State License: EPA
 Signature: [Signature] Date: 03/06/08 Signature: [Signature] Date: 03/06/08

Asbestos-Containing Material: No Yes ASSUMED

SUSPECT ASBESTOS-CONTAINING MATERIAL DESIGNATION AND SAMPLE RECORD FORM



15974 N. 77th Street
 Scottsdale, AZ 85260
 (602) 277-7877
 (602) 277-8288 fax

Project No.: 08-085 Project Name: AHERA Compliance Inspection Owner: Kyrene School District No. 28
 Building No.: Main Building Address: 14841 S. 41st place
 Campus Name: Kyrene de la Esperanza Phoenix, AZ 85044

Material Code: MGR-SS Damaged: Yes No Friable Non-Friable
 General Description: GROW Size: N/A

Matrix/Primary Color: GRAY Texture/Pattern: CEMENTITIOUS Cover/Secondary Color: N/A
 Quantity of Material: 320 Estimated By: Drawing Field Measure
 Homogeneous Material Location: Ceiling Floor Wall Other

Manner of Sampling: Random Convenience N/A

Sample ID	Sample Location	Points of Origin	East/West Direction	North/South Direction	Height A.F.F.	Surface
A		Corner				F / W / C / O
B		Corner				F / W / C / O
C		Corner				F / W / C / O
D		Corner				F / W / C / O
E		Corner				F / W / C / O
F		Corner				F / W / C / O
G		Corner				F / W / C / O

Comments: ASSOCIATED WITH M.C.M.T. SH

Inspector: Dane Thompson Inspector: Michael Richter
 AHERA Certificate No.: D9953 State License: EPA AHERA Certificate No.: D10790 State License: EPA
 Signature: [Signature] Date: 03/06/08 Signature: [Signature] Date: 03/06/08

Asbestos-Containing Material: No Yes ASSUMED

SUSPECT ASBESTOS-CONTAINING MATERIAL DESIGNATION AND SAMPLE RECORD FORM



15974 N. 77th Street
 Scottsdale, AZ 85260
 (602) 277-7877
 (602) 277-8288 fax

Project No.: 08-085 Project Name: AHERA Compliance Inspection Owner: Kyrene School District No. 28
 Building No.: Main Building Address: 14841 S. 41st place
 Campus Name: Kyrene de la Esperanza Phoenix, AZ 85044

Material Code: M-ADH-56 Damaged: Yes No Friable Non-Friable
 General Description: ADHESIVE Visible Covered FRP Size: N/A

Matrix/Primary Color: BROWN Texture/Pattern: BRITTE Cover/Secondary Color: N/A
 Quantity of Material: 100 Estimated By: Drawing Field Measure Sampled Assumed
 Homogeneous Material Location: Ceiling Floor Wall Other

Manner of Sampling: Random Convenience N/A

Sample ID	Sample Location	Points of Origin	East/West Direction	North/South Direction	Height A.F.F.	Surface
A		Corner				F / W / C / O
B		Corner				F / W / C / O
C		Corner				F / W / C / O
D		Corner				F / W / C / O
E		Corner				F / W / C / O
F		Corner				F / W / C / O
G		Corner				F / W / C / O

Comments: ASSOCIATED WITH FIBERGLASS REINFORCED PANELING, WHITE, TEXTURED

Inspector: Dane Thompson Inspector: Michael Richter
 AHERA Certificate No.: D9953 State License: EPA AHERA Certificate No.: D10790 State License: EPA
 Signature: [Signature] Date: 03/06/08 Signature: [Signature] Date: 03/06/08

Asbestos-Containing Material: No Yes ASSUMED

SUSPECT ASBESTOS-CONTAINING MATERIAL DESIGNATION AND SAMPLE RECORD FORM



15974 N. 77th Street
 Scottsdale, AZ 85260
 (602) 277-7877
 (602) 277-8288 fax

Project No.: 08-085 Project Name: AHERA Compliance Inspection Owner: Kyrene School District No. 28
 Building No.: Main Building Address: 14841 S. 41st place
 Campus Name: Kyrene de la Esperanza Phoenix, AZ 85044

Material Code: M-PSL-57 Damaged: Yes No Friable Non-Friable
 General Description: PIPE SEALANT Size: N/A

Matrix/Primary Color: GREEN Texture/Pattern: GUMMY Cover/Secondary Color: N/A
 Quantity of Material: 2 Estimated By: Drawing Field Measure Sampled Assumed

Homogeneous Material Location: Ceiling Floor Wall Other
 Manner of Sampling: Random Convenience N/A

Sample ID	Sample Location	Points of Origin	East/West Direction	North/South Direction	Height A.F.F.	Surface
A		Corner				F / W / C / O
B		Corner				F / W / C / O
C		Corner				F / W / C / O
D		Corner				F / W / C / O
E		Corner				F / W / C / O
F		Corner				F / W / C / O
G		Corner				F / W / C / O

Comments: _____

Inspector: Dane Thompson Inspector: Michael Richter
 AHERA Certificate No.: D9953 State License: EPA AHERA Certificate No.: D10790 State License: EPA
 Signature: *[Signature]* Date: 03/06/08 Signature: *[Signature]* Date: 03/06/08

Asbestos-Containing Material: No Yes ASSUMED

SUSPECT ASBESTOS-CONTAINING MATERIAL DESIGNATION AND SAMPLE RECORD FORM



15974 N. 77th Street
 Scottsdale, AZ 85260
 (602) 277-7877
 (602) 277-8288 fax

Project No.: 08-085 Project Name: AHERA Compliance Inspection Owner: Kyrene School District No. 28
 Building No.: Main Building Address: 14841 S. 41st place
 Campus Name: Kyrene de la Esperanza Phoenix, AZ 85044

Material Code: M-SLT-58 Damaged: Yes No Friable Non-Friable
 General Description: SEALANT (EQUIPMENT) Visible Covered Size: N/A

Matrix/Primary Color: BLACK Texture/Pattern: GUMMY Cover/Secondary Color: N/A
 Quantity of Material: 2 Estimated By: Drawing Field Measure Sampled Assumed

Homogeneous Material Location: Ceiling Floor Wall Other

Manner of Sampling: Random Convenience N/A

Sample ID	Sample Location	Points of Origin	East/West Direction	North/South Direction	Height A.F.F.	Surface
A		Corner				F / W / C / O
B		Corner				F / W / C / O
C		Corner				F / W / C / O
D		Corner				F / W / C / O
E		Corner				F / W / C / O
F		Corner				F / W / C / O
G		Corner				F / W / C / O

Comments: _____

Inspector: Dane Thompson Inspector: Michael Richter
 AHERA Certificate No.: D9953 State License: EPA AHERA Certificate No.: D10790 State License: EPA
 Signature: [Signature] Date: 03/06/08 Signature: [Signature] Date: 03/06/08

Asbestos-Containing Material: No Yes ASSUMED

SUSPECT ASBESTOS-CONTAINING MATERIAL DESIGNATION AND SAMPLE RECORD FORM



15974 N. 77th Street
 Scottsdale, AZ 85260
 (602) 277-7877
 (602) 277-8288 fax

Project No.: 08-085 Project Name: AHERA Compliance Inspection Owner: Kyrene School District No. 28
 Building No.: Main Building Address: 14841 S. 41st place
 Campus Name: Kyrene de la Esperanza Phoenix, AZ 85044

Material Code: W.A.P.L.-59 Damaged: Yes No Friable Non-Friable
 Visible Covered Size: 2'x2'

General Description: ACOUSTICAL CEILING PANEL Cover/Secondary Color: CLOROX COVER
 Matrix/Primary Color: YELLOW Texture/Pattern: FIBROUS GLASS
 Quantity of Material: 1750 Estimated By: Drawing Sampled
 SF / LF / EA Field Measure Assumed

Homogeneous Material Location: Ceiling Floor Wall Other
 Manner of Sampling: Random Convenience N/A

Sample ID	Sample Location	Points of Origin	East/West Direction	North/South Direction	Height A.F.F.	Surface
A		Corner				F / W / C / O
B		Corner				F / W / C / O
C		Corner				F / W / C / O
D		Corner				F / W / C / O
E		Corner				F / W / C / O
F		Corner				F / W / C / O
G		Corner				F / W / C / O

Comments: _____

Inspector: Dane Thompson Inspector: Michael Richter
 AHERA Certificate No.: D9953 State License: EPA AHERA Certificate No.: D10790 State License: EPA
 Signature: [Signature] Date: 03/06/08 Signature: [Signature] Date: 03/06/08

Asbestos-Containing Material: No Yes Assumed

SUSPECT ASBESTOS-CONTAINING MATERIAL DESIGNATION AND SAMPLE RECORD FORM



15974 N. 77th Street
 Scottsdale, AZ 85260
 (602) 277-7877
 (602) 277-8288 fax

Project No.: 08-085 Project Name: AHERA Compliance Inspection Owner: Kyrene School District No. 28
 Building No.: Main Building Address: 14841 S. 41st place
 Campus Name: Kyrene de la Esperanza Phoenix, AZ 85044

Material Code: 41-VCT-60 Damaged: Yes No Friable Non-Friable
 General Description: VINYL COMPOSITION TILE (Strip) Size: 2" x 24"

Matrix/Primary Color: RED Texture/Pattern: Smooth Cover/Secondary Color: N/A
 Quantity of Material: 5 Estimated By: Drawing Sampled Assumed
 Field Measure

Homogeneous Material Location: Ceiling Floor Wall Other

Manner of Sampling: Random Convenience N/A

Sample ID	Sample Location	Points of Origin	East/West Direction	North/South Direction	Height A.F.F.	Surface
A	3S	SW Corner	E 10'	N 25'	0'	F/W/C/O
B		SW Corner	E 30'	N 25'	0'	F/W/C/O
C		SW Corner	E 20'	N 15'	0'	F/W/C/O
D		Corner				F/W/C/O
E		Corner				F/W/C/O
F		Corner				F/W/C/O
G		Corner				F/W/C/O

Comments: _____

Inspector: Dane Thompson Inspector: Michael Richter
 AHERA Certificate No.: D9953 State License: EPA AHERA Certificate No.: D10790 State License: EPA
 Signature: [Signature] Date: 03/06/08 Signature: [Signature] Date: 03/06/08

Asbestos-Containing Material: No Yes

SUSPECT ASBESTOS-CONTAINING MATERIAL DESIGNATION AND SAMPLE RECORD FORM



15974 N. 77th Street
 Scottsdale, AZ 85260
 (602) 277-7877
 (602) 277-9288 fax

Project No.: 08-085 Project Name: AHERA Compliance Inspection Owner: Kyrene School District No. 28
 Building No.: Main Building Address: 14841 S. 41st place
 Campus Name: Kyrene de la Esperanza Phoenix, AZ 85044

Material Code: M-VCP-61 Damaged: Yes No Friable Non-Friable
 General Description: VINYL COMPOSITION SLICE (Skrip) Size: 2" x 24"

Matrix/Primary Color: BLUE Texture/Pattern: SMOOTH Cover/Secondary Color: N/A
 Quantity of Material: 5 Estimated By: Drawing Sampled Assumed
 SF / LF / EA Field Measure
 Homogeneous Material Location: Ceiling Floor Wall Other

Manner of Sampling: Random Convenience N/A

Sample ID	Sample Location	Points of Origin	East/West Direction	North/South Direction	Height A.F.F.	Surface
A	35	SW Corner	E 15'	N 25'	0'	F W I C I O
B	I	SW Corner	E 30'	N 20'	0'	F W I C I O
C	I	SW Corner	E 30'	N 15'	0'	F W I C I O
D		Corner				F W I C I O
E		Corner				F W I C I O
F		Corner				F W I C I O
G		Corner				F W I C I O

Comments: _____

Inspector: Dane Thompson Inspector: Michael Richter
 AHERA Certificate No.: D9953 State License: EPA AHERA Certificate No.: D10790 State License: EPA
 Signature: [Signature] Date: 03/06/08 Signature: [Signature] Date: 03/06/08

Asbestos-Containing Material: No Yes

SUSPECT ASBESTOS-CONTAINING MATERIAL DESIGNATION AND SAMPLE RECORD FORM



15974 N. 77th Street
 Scottsdale, AZ 85260
 (602) 277-7877
 (602) 277-8288 fax

FM GROUP/forms/SuspACMDesigRecord.omf

Project No.: 08-085 Project Name: AHERA Compliance Inspection Owner: Kyrene School District No. 28
 Building No.: Main Building Address: 14841 S. 41st place
 Campus Name: Kyrene de la Esperanza Phoenix, AZ 85044

Material Code: M-VCF-62 Damaged: Yes No Friable Non-Friable
 General Description: VINYL COMPOSITION TILE (Strip) Size: 2' x 24"

Matrix/Primary Color: BLACK Texture/Pattern: SMOOTH Cover/Secondary Color: N/A
 Quantity of Material: 5 Estimated By: Drawing Sampled Assumed
 Field Measure

Homogeneous Material Location: Ceiling Floor Wall Other
 Manner of Sampling: Random Convenience N/A

Sample ID	Sample Location	Points of Origin	East/West Direction	North/South Direction	Height A.F.F.	Surface
A	35	SW Corner	E 10'	N 30'	0'	F/W/C/O
B	L	SW Corner	E 15'	N 35'	0'	F/W/C/O
C	L	SW Corner	E 20'	N 30'	0'	F/W/C/O
D		Corner				F/W/C/O
E		Corner				F/W/C/O
F		Corner				F/W/C/O
G		Corner				F/W/C/O

Comments: _____

Inspector: Dane Thompson Inspector: Michael Richter
 AHERA Certificate No.: D9953 State License: EPA AHERA Certificate No.: D10790 State License: EPA
 Signature: *DM* Date: 03/06/08 Signature: *[Signature]* Date: 03/06/08

Asbestos-Containing Material: No Yes

SUSPECT ASBESTOS-CONTAINING MATERIAL DESIGNATION AND SAMPLE RECORD FORM



15974 N. 77th Street
 Scottsdale, AZ 85260
 (602) 277-7877
 (602) 277-8288 fax

FM GROUP/forms/SuspACMDesigRecord.omf

Project No.: 08-085 Project Name: AHERA Compliance Inspection Owner: Kyrene School District No. 28
 Building No.: Main Building Address: 14841 S. 41st place
 Campus Name: Kyrene de la Esperanza Phoenix, AZ 85044

Material Code: M-VCT-683 Damaged: Yes No Friable Non-Friable
 General Description: VINYL COMPOSITION TAPE (SCTP) Size: 2" x 24"

Matrix/Primary Color: YELLOW Cover/Secondary Color: N/A
 Quantity of Material: 5 Estimated By: Drawing Field Measure
 Homogeneous Material Location: Ceiling Floor Wall Other

Manner of Sampling: Random Convenience N/A

Sample ID	Sample Location	Points of Origin	East/West Direction	North/South Direction	Height A.F.F.	Surface
A	35	SW Corner	E 15'	N 20'	0'	F/W/C/O
B	1	SW Corner	E 20'	N 25'	0'	F/W/C/O
C	1	SW Corner	E 25'	N 20'	0'	F/W/C/O
D		Corner				F/W/C/O
E		Corner				F/W/C/O
F		Corner				F/W/C/O
G		Corner				F/W/C/O

Comments: _____

Inspector: Dane Thompson State License: EPA D9953
 Inspector: Michael Richter State License: EPA D10790
 AHERA Certificate No.: _____ AHERA Certificate No.: _____
 Signature: _____ Signature: _____
 Date: 03/06/08 Date: 03/06/08

Asbestos-Containing Material: No Yes

SUSPECT ASBESTOS-CONTAINING MATERIAL DESIGNATION AND SAMPLE RECORD FORM

15974 N. 77th Street
 Scottsdale, AZ 85260
 (602) 277-7877
 (602) 277-8288 fax

FM GROUP INC

Project No.: 08-085 Project Name: AHERA Compliance Inspection Owner: Kyrene School District No. 28
 Building No.: Main Building Address: 14841 S. 41st place
 Campus Name: Kyrene de la Esperanza Phoenix, AZ 85044

Material Code: M.V.C.F. 64 Damaged: Yes No Friable Non-Friable
 General Description: VINYL COMPOSITION STIC (Strip) Size: 2" x 24"

Matrix/Primary Color: GREEN Texture/Pattern: SM DOTT Cover/Secondary Color: N/A
 Quantity of Material: 5 Estimated By: Drawing Field Measure

Homogeneous Material Location: Ceiling Floor Wall Other
 Manner of Sampling: Random Convenience N/A

Sample ID	Sample Location	Points of Origin	East/West Direction	North/South Direction	Height A.F.F.	Surface
A	35	SW Corner	E 15'	N 30'	0'	F/W/C/O
B		SW Corner	E 20'	N 25'	0'	F/W/C/O
C		SW Corner	E 15'	N 35'	0'	F/W/C/O
D		Corner				F/W/C/O
E		Corner				F/W/C/O
F		Corner				F/W/C/O
G		Corner				F/W/C/O

Comments: _____

Inspector: Dane Thompson Inspector: Michael Richter
 AHERA Certificate No.: D9953 State License: EPA AHERA Certificate No.: D10790 State License: EPA
 Signature: [Signature] Date: 03/06/08 Signature: [Signature] Date: 03/06/08

Asbestos-Containing Material: No Yes

SUSPECT ASBESTOS-CONTAINING MATERIAL DESIGNATION AND SAMPLE RECORD FORM



15974 N. 77th Street
 Scottsdale, AZ 85260
 (602) 277-7877
 (602) 277-8288 fax

Project No.: 08-085 Project Name: AHERA Compliance Inspection Owner: Kyrene School District No. 28
 Building No.: Main Building Address: 14841 S. 41st place
 Campus Name: Kyrene de la Esperanza Phoenix, AZ 85044

Material Code: MAP-65 Damaged: Yes No Friable Non-Friable
 General Description: ACOUSTICAL CEILING PANEL Size: 2'x4'

Matrix/Primary Color: WHITE Texture/Pattern: CHALKY Cover/Secondary Color: VINYL COVER
 Quantity of Material: 600 Estimated By: Drawing Sampled
 Field Measure

Homogeneous Material Location: Ceiling Floor Wall Other
 Manner of Sampling: Random Convenience N/A

Sample ID	Sample Location	Points of Origin	East/West Direction	North/South Direction	Height A.F.F.	Surface
A	<u>37</u>	NW Corner	E 5'	S 5'	10'	F / W / <u>C</u> / O
B	<u>I</u>	NW Corner	E 10'	S 10'	10'	F / W / <u>C</u> / O
C	<u>I</u>	NW Corner	E 15'	S 15'	10'	F / W / <u>C</u> / O
D		Corner				F / W / C / O
E		Corner				F / W / C / O
F		Corner				F / W / C / O
G		Corner				F / W / C / O

Comments: _____

Inspector: Dane Thompson Inspector: Michael Richter
 AHERA Certificate No.: D9953 State License: EPA AHERA Certificate No.: D10790 State License: EPA
 Signature: [Signature] Date: 03/06/08 Signature: [Signature] Date: 03/06/08

Asbestos-Containing Material: No Yes

SUSPECT ASBESTOS-CONTAINING MATERIAL DESIGNATION AND SAMPLE RECORD FORM



15974 N. 77th Street
 Scottsdale, AZ 85260
 (602) 277-7877
 (602) 277-8288 fax

Project No.: 08-085 Project Name: AHERA Compliance Inspection Owner: Kyrene School District No. 28
 Building No.: Main Building Address: 14841 S. 41st place
 Campus Name: Kyrene de la Esperanza Phoenix, AZ 85044

Material Code: 5-SAT-660 Damaged: Yes No Friable Non-Friable
 General Description: SPRAY-APPLIED TEXTURE Size: N/A

Matrix/Primary Color: WHITE Texture/Pattern: CHALKY Cover/Secondary Color: N/A
 Quantity of Material: 3000 Estimated By: Drawing Field Measure
 Sampled Assumed

Homogeneous Material Location: Ceiling Floor Wall Other

Manner of Sampling: Random Convenience N/A

Sample ID	Sample Location	Points of Origin	East/West Direction	North/South Direction	Height A.F.F.	Surface
A		Corner				F / W / C / O
B		Corner				F / W / C / O
C		Corner				F / W / C / O
D		Corner				F / W / C / O
E		Corner				F / W / C / O
F		Corner				F / W / C / O
G		Corner				F / W / C / O

Comments:

Inspector: Dane Thompson Inspector: Michael Richter
 AHERA Certificate No.: D9953 State License: EPA AHERA Certificate No.: D10790 State License: EPA
 Signature: [Signature] Date: 03/06/08 Signature: [Signature] Date: 03/06/08

Asbestos-Containing Material: No Yes **ASSUMED**

SUSPECT ASBESTOS-CONTAINING MATERIAL DESIGNATION AND SAMPLE RECORD FORM



15974 N. 77th Street
 Scottsdale, AZ 85260
 (602) 377-7877
 (602) 277-8288 fax

Project No.: 08-085 Project Name: AHERA Compliance Inspection Owner: Kyrene School District No. 28
 Building No.: Main Building Address: 14841 S. 41st place
 Campus Name: Kyrene de la Esperanza Phoenix, AZ 85044

Material Code: M.GWB.607 Damaged: Yes No Friable Non-Friable
 General Description: Gypsum Wallboard Visible Covered Size: N/A

Matrix/Primary Color: White Texture/Pattern: Chalky Cover/Secondary Color: N/A
 Quantity of Material: 3000 Estimated By: Drawing Field Measure
 Homogeneous Material Location: Ceiling Floor Wall Other

Manner of Sampling: Random Convenience N/A

Sample ID	Sample Location	Points of Origin	East/West Direction	North/South Direction	Height A.F.F.	Surface
A		Corner				F / W / C / O
B		Corner				F / W / C / O
C		Corner				F / W / C / O
D		Corner				F / W / C / O
E		Corner				F / W / C / O
F		Corner				F / W / C / O
G		Corner				F / W / C / O

Comments: ASSOCIATED WITH S.SAT.604

Inspector: Dane Thompson Inspector: Michael Richter
 AHERA Certificate No.: D9953 State License: EPA AHERA Certificate No.: D10799 State License: EPA
 Signature: [Signature] Date: 03/06/08 Signature: [Signature] Date: 03/06/08

Asbestos-Containing Material: No Yes ASSUMED

SUSPECT ASBESTOS-CONTAINING MATERIAL DESIGNATION AND SAMPLE RECORD FORM



15974 N. 77th Street
 Scottsdale, AZ 85260
 (602) 277-7877
 (602) 277-8288 fax

Project No.: 08-085 Project Name: AHERA Compliance Inspection Owner: Kyrene School District No. 28
 Building No.: Main Building Address: 14841 S. 41st place
 Campus Name: Kyrene de la Esperanza Phoenix, AZ 85044

Material Code: S.JTC-68 Damaged: Yes No Friable Non-Friable
 General Description: JOINT COMPOUND Visible Covered SAT Size: N/A

Matrix/Primary Color: WHITE Texture/Pattern: CHALKY Cover/Secondary Color: N/A
 Quantity of Material: 300 Estimated By: Drawing Field Measure Sampled Assumed
 Homogeneous Material Location: Ceiling Floor Wall Other

Manner of Sampling: Random Convenience N/A

Sample ID	Sample Location	Points of Origin	East/West Direction	North/South Direction	Height A.F.F.	Surface
A		Corner				F / W / C / O
B		Corner				F / W / C / O
C		Corner				F / W / C / O
D		Corner				F / W / C / O
E		Corner				F / W / C / O
F		Corner				F / W / C / O
G		Corner				F / W / C / O

Comments: ASSOCIATED W/IRJ M.G.W.B.-67

Inspector: Dane Thompson Inspector: Michael Richter
 AHERA Certificate No.: D9953 State License: EPA AHERA Certificate No.: D10790 State License: EPA
 Signature: [Signature] Date: 03/06/08 Signature: [Signature] Date: 03/06/08

Asbestos-Containing Material: No Yes ASSUMED

SUSPECT ASBESTOS-CONTAINING MATERIAL DESIGNATION AND SAMPLE RECORD FORM



15974 N. 77th Street
 Scottsdale, AZ 85260
 (602) 277-7877
 (602) 277-8288 fax

Project No.: 08-085 Project Name: AHERA Compliance Inspection Owner: Kyrene School District No. 28
 Building No.: Main Building Address: 14841 S. 41st place
 Campus Name: Kyrene de la Esperanza Phoenix, AZ 85044

Material Code: M-08-09 Damaged: Yes No Friable Non-Friable
 General Description: QUARRY/PAVER TILES Size: 8'x8'

Matrix/Primary Color: WHITE Texture/Pattern: SMOOTH Cover/Secondary Color: N/A
 Quantity of Material: 30 Estimated By: Drawing Field Measure
 Homogeneous Material Location: Ceiling Floor Wall Other

Manner of Sampling: Random Convenience N/A

Sample ID	Sample Location	Points of Origin	East/West Direction	North/South Direction	Height A.F.F.	Surface
A		Corner				F / W / C / O
B		Corner				F / W / C / O
C		Corner				F / W / C / O
D		Corner				F / W / C / O
E		Corner				F / W / C / O
F		Corner				F / W / C / O
G		Corner				F / W / C / O

Comments:

Inspector: Dane Thompson Inspector: Michael Richter
 AHERA Certificate No.: D9953 State License: EPA AHERA Certificate No.: D10790 State License: EPA
 Signature: [Signature] Date: 03/06/08 Signature: [Signature] Date: 03/06/08

Asbestos-Containing Material: No Yes ASSUMED

SUSPECT ASBESTOS-CONTAINING MATERIAL DESIGNATION AND SAMPLE RECORD FORM



15974 N. 77th Street
 Scottsdale, AZ 85260
 (602) 277-7877
 (602) 277-8288 fax

Project No.: 08-085 Project Name: AHERA Compliance Inspection Owner: Kyrene School District No. 28
 Building No.: Main Building Address: 14841 S. 41st place
 Campus Name: Kyrene de la Esperanza Phoenix, AZ 85044

Material Code: M-GRT-70 Damaged: Yes No Friable Non-Friable
 General Description: GROUP Visible Covered Size: N/A

Matrix/Primary Color: GRAY Texture/Pattern: CEMENTITIOUS Cover/Secondary Color: N/A
 Quantity of Material: 3 Estimated By: Drawing Field Measure Sampled Assumed
 Homogeneous Material Location: Ceiling Floor Wall Other

Manner of Sampling: Random Convenience N/A

Sample ID	Sample Location	Points of Origin	East/West Direction	North/South Direction	Height A.F.F.	Surface
A		Corner				F / W / C / O
B		Corner				F / W / C / O
C		Corner				F / W / C / O
D		Corner				F / W / C / O
E		Corner				F / W / C / O
F		Corner				F / W / C / O
G		Corner				F / W / C / O

Comments: ASSOCIATED WITH M.O.P.T. 107

Inspector: Dane Thompson State License: EPA D9953 Michael Richter State License: EPA D10790
 AHERA Certificate No.: Signature: Date: 03/06/08
 Signature: Date: 03/06/08

Asbestos-Containing Material: No Yes ASSUMED

SUSPECT ASBESTOS-CONTAINING MATERIAL DESIGNATION AND SAMPLE RECORD FORM



15974 N. 77th Street
 Scottsdale, AZ 85260
 (602) 277-7877
 (602) 277-8288 fax

Project No.: 08-085 Project Name: AHERA Compliance Inspection Owner: Kyrene School District No. 28
 Building No.: Main Building Address: 14841 S. 41st place
 Campus Name: Kyrene de la Esperanza Phoenix, AZ 85044

Material Code: M-VSF-71 Damaged: Yes No Friable Non-Friable
 General Description: VINYL SHEET FLOORING Size: N/A
 Matrix/Primary Color: BLUE Texture/Pattern: SMOOTH Cover/Secondary Color: WHITE MOTIFLES
 Quantity of Material: 1200 Estimated By: Drawing Field Measure Sampled Assumed
 Homogeneous Material Location: Ceiling Floor Wall Other

Manner of Sampling: Random Convenience N/A

Sample ID	Sample Location	Points of Origin	East/West Direction	North/South Direction	Height A.F.F.	Surface
A		Corner				F / W / C / O
B		Corner				F / W / C / O
C		Corner				F / W / C / O
D		Corner				F / W / C / O
E		Corner				F / W / C / O
F		Corner				F / W / C / O
G		Corner				F / W / C / O

Comments: Gray Paper Backing

Inspector: Dane Thompson Inspector: Michael Richter
 AHERA Certificate No.: D9953 State License: EPA AHERA Certificate No.: D10790 State License: EPA
 Signature: DM Date: 03/06/08 Signature: [Signature] Date: 03/06/08

Asbestos-Containing Material: No Yes ASSUMED

SUSPECT ASBESTOS-CONTAINING MATERIAL DESIGNATION AND SAMPLE RECORD FORM



15974 N. 77th Street
 Scottsdale, AZ 85260
 (602) 277-7877
 (602) 277-9288 fax

FM GROUP/forms/SuspACMDesigRecord.ontf

Project No.: 08-085 Project Name: AHERA Compliance Inspection Owner: Kyrene School District No. 28
 Building No.: Main Building Address: 14841 S. 41st place
 Campus Name: Kyrene de la Esperanza Phoenix, AZ 85044

Material Code: M-NAS-72 Damaged: Yes No Friable Non-Friable
 General Description: NASALC Size: N/A
 Visible Covered VSF

Matrix/Primary Color: YELLOW Texture/Pattern: FLAKY Cover/Secondary Color: N/A
 Quantity of Material: 1200 Estimated By: Drawing Field Measure
 Sampling Drawing Field Measure

Homogeneous Material Location: Ceiling Floor Wall Other
 Manner of Sampling: Random Convenience N/A

Sample ID	Sample Location	Points of Origin	East/West Direction	North/South Direction	Height A.F.F.	Surface
A		Corner				F / W / C / O
B		Corner				F / W / C / O
C		Corner				F / W / C / O
D		Corner				F / W / C / O
E		Corner				F / W / C / O
F		Corner				F / W / C / O
G		Corner				F / W / C / O

Comments: ASSOCIATED WITH M-VSF.71

Inspector: Dane Thompson Inspector: Michael Richter
 AHERA Certificate No.: D9953 State License: EPA AHERA Certificate No.: D10790 State License: EPA
 Signature: [Signature] Date: 03/06/08 Signature: [Signature] Date: 03/06/08

Asbestos-Containing Material: No Yes ASSUMED

SUSPECT ASBESTOS-CONTAINING MATERIAL DESIGNATION AND SAMPLE RECORD FORM



15974 N. 77th Street
 Scottsdale, AZ 85260
 (602) 277-7877
 (602) 277-8288 fax

Project No.: 08-085 Project Name: AHERA Compliance Inspection Owner: Kyrene School District No. 28
 Building No.: Main Building Address: 14841 S. 41st place
 Campus Name: Kyrene de la Esperanza Phoenix, AZ 85044

Material Code: M.C.A. 73 Damaged: Yes No Friable Non-Friable
 General Description: CARPET Size: N/A

Matrix/Primary Color: BROWN Texture/Pattern: FIBROUS Cover/Secondary Color: N/A
 Quantity of Material: 1200 Estimated By: Drawing Field Measure Sampled Assumed
 Homogeneous Material Location: Ceiling Floor Wall Other

Manner of Sampling: Random Convenience N/A

Sample ID	Sample Location	Points of Origin	East/West Direction	North/South Direction	Height A.F.F.	Surface
A		Corner				F / W / C / O
B		Corner				F / W / C / O
C		Corner				F / W / C / O
D		Corner				F / W / C / O
E		Corner				F / W / C / O
F		Corner				F / W / C / O
G		Corner				F / W / C / O

Comments:

Inspector: Dane Thompson Inspector: Michael Richter
 AHERA Certificate No.: D9953 State License: EPA AHERA Certificate No.: D19790 State License: EPA
 Signature: *[Signature]* Date: 03/06/08 Signature: *[Signature]* Date: 03/06/08

Asbestos-Containing Material: No Yes ASSUMED

SUSPECT ASBESTOS-CONTAINING MATERIAL DESIGNATION AND SAMPLE RECORD FORM



15974 N. 77th Street
 Scottsdale, AZ 85260
 (602) 277-7877
 (602) 277-8288 fax

Project No.: 08-085 Project Name: AHERA Compliance Inspection Owner: Kyrene School District No. 28
 Building No.: Main Building Address: 14841 S. 41st place
 Campus Name: Kyrene de la Esperanza Phoenix, AZ 85044

Material Code: M. MAS-74 Visible Covered Damaged: Yes No Friable Non-Friable
 General Description: MASTIC Size: N/A

Matrix/Primary Color: YELLOW Texture/Pattern: STACKY Cover/Secondary Color: N/A
 Quantity of Material: 1200 Estimated By: Drawing Field Measure
 Homogeneous Material Location: Ceiling Floor Wall Other

Manner of Sampling: Random Convenience N/A

Sample ID	Sample Location	Points of Origin	East/West Direction	North/South Direction	Height A.F.F.	Surface
A		Corner				F / W / C / O
B		Corner				F / W / C / O
C		Corner				F / W / C / O
D		Corner				F / W / C / O
E		Corner				F / W / C / O
F		Corner				F / W / C / O
G		Corner				F / W / C / O

Comments: ASSOCIATED WITH M.C.P. 73

Inspector: Dane Thompson Inspector: Michael Richter
 AHERA Certificate No.: D9953 State License: EPA AHERA Certificate No.: D10790 State License: EPA
 Signature: [Signature] Date: 03/06/08 Signature: [Signature] Date: 03/06/08

Asbestos-Containing Material: No Yes ASSUMED

SUSPECT ASBESTOS-CONTAINING MATERIAL DESIGNATION AND SAMPLE RECORD FORM



15974 N. 77th Street
 Scottsdale, AZ 85260
 (602) 277-7877
 (602) 277-8288 fax

Project No.: 08-085 Project Name: AHERA Compliance Inspection Owner: Kyrene School District No. 28
 Building No.: Main Building Address: 14841 S. 41st place
 Campus Name: Kyrene de la Esperanza Phoenix, AZ 85044

Material Code: M-GNF-75 Material: Visible Covered Friable Non-Friable
 General Description: GLAZED WALL TILE Size: 4" X 4"

Matrix/Primary Color: WHITE Texture/Pattern: SMOOYTH Cover/Secondary Color: N/A
 Quantity of Material: 60 Estimated By: Drawing Field Measure Sampled Assumed

Homogeneous Material Location: Ceiling Floor Wall Other
 Manner of Sampling: Random Convenience N/A

Sample ID	Sample Location	Points of Origin	East/West Direction	North/South Direction	Height A.F.F.	Surface
A		Corner				F / W / C / O
B		Corner				F / W / C / O
C		Corner				F / W / C / O
D		Corner				F / W / C / O
E		Corner				F / W / C / O
F		Corner				F / W / C / O
G		Corner				F / W / C / O

Comments:

Inspector: Dane Thompson Inspector: Michael Richter
 AHERA Certificate No.: D9953 State License: EPA AHERA Certificate No.: D10790 State License: EPA
 Signature: [Signature] Date: 03/06/08 Signature: [Signature] Date: 03/06/08

Asbestos-Containing Material: No Yes AS SUMED

SUSPECT ASBESTOS-CONTAINING MATERIAL DESIGNATION AND SAMPLE RECORD FORM



15974 N. 77th Street
 Scottsdale, AZ 85260
 (602) 277-7877
 (602) 277-9288 fax

Project No.: 08-085 Project Name: AHERA Compliance Inspection Owner: Kyrene School District No. 28
 Building No.: Main Building Address: 14841 S. 41st place
 Campus Name: Kyrene de la Esperanza Phoenix, AZ 85044

Material Code: M-GRY-76 Damaged: Yes No Friable Non-Friable
 General Description: GROUT Size: N/A

Matrix/Primary Color: GRAY Texture/Pattern: CEMENTITIOUS Cover/Secondary Color: N/A
 Quantity of Material: 60 Estimated By: Drawing Field Measure

Homogeneous Material Location: Ceiling Floor Wall Other

Manner of Sampling: Random Convenience N/A

Sample ID	Sample Location	Points of Origin	East/West Direction	North/South Direction	Height A.F.F.	Surface
A		Corner				F / W / C / O
B		Corner				F / W / C / O
C		Corner				F / W / C / O
D		Corner				F / W / C / O
E		Corner				F / W / C / O
F		Corner				F / W / C / O
G		Corner				F / W / C / O

Comments: ASSOCIATED WITH M-GRY-75

Inspector: Dane Thompson Inspector: Michael Richter
 AHERA Certificate No.: D9953 State License: EPA AHERA Certificate No.: D10790 State License: EPA
 Signature: [Signature] Date: 03/06/08 Signature: [Signature] Date: 03/06/08

Asbestos-Containing Material: No Yes ASSUMED

SUSPECT ASBESTOS-CONTAINING MATERIAL DESIGNATION AND SAMPLE RECORD FORM



16974 N. 77th Street
 Scottsdale, AZ 85260
 (602) 277-7877
 (602) 277-9288 fax

FM GROUP/forms/SuspACMDesigRecord.oft

Project No.: 08-085 Project Name: AHERA Compliance Inspection Owner: Kyrene School District No. 28
 Building No.: Main Building Address: 14841 S. 41st place
 Campus Name: Kyrene de la Esperanza Phoenix, AZ 85044

Material Code: M-SEF-77 Damaged: Yes No Friable Non-Friable
 General Description: SEALANT (DOORS, WINDOWS, MILLWORK, FIXTURES) Size: N/A

Matrix/Primary Color: WHITE Cover/Secondary Color: N/A
 Quantity of Material: 11 Texture/Pattern: FRIABLE Estimated By: Drawing Field Measure
 Homogeneous Material Location: Ceiling Floor Wall Other

Manner of Sampling: Random Convenience N/A

Sample ID	Sample Location	Points of Origin	East/West Direction	North/South Direction	Height A.F.F.	Surface
A		Corner				F / W / C / O
B		Corner				F / W / C / O
C		Corner				F / W / C / O
D		Corner				F / W / C / O
E		Corner				F / W / C / O
F		Corner				F / W / C / O
G		Corner				F / W / C / O

Comments:

Inspector: Dane Thompson Inspector: Michael Richter
 AHERA Certificate No.: D9953 State License: EPA AHERA Certificate No.: D10790 State License: EPA
 Signature: [Signature] Date: 03/06/08 Signature: [Signature] Date: 03/06/08

Asbestos-Containing Material: No Yes **ASSUMED**

SUSPECT ASBESTOS-CONTAINING MATERIAL DESIGNATION AND SAMPLE RECORD FORM



15974 N. 77th Street
 Scottsdale, AZ 85260
 (602) 277-7877
 (602) 277-8288 fax

Project No.: 08-085 Project Name: AHERA Compliance Inspection Owner: Kyrene School District No. 28
 Building No.: Main Building Address: 14841 S. 41st place
 Campus Name: Kyrene de la Esperanza Phoenix, AZ 85044

Material Code: M-MRT-78 Damaged: Yes No Friable Non-Friable
 General Description: MORTAR Size: N/A

Matrix/Primary Color: GRAY Cover/Secondary Color: N/A
 Quantity of Material: 2 Estimated By: Drawing Field Measure
 Texture/Pattern: CEMENTITIOUS

Homogeneous Material Location: Ceiling Floor Wall Other

Manner of Sampling: Random Convenience N/A

Sample ID	Sample Location	Points of Origin	East/West Direction	North/South Direction	Height A.F.F.	Surface
A		Corner				F / W / C / O
B		Corner				F / W / C / O
C		Corner				F / W / C / O
D		Corner				F / W / C / O
E		Corner				F / W / C / O
F		Corner				F / W / C / O
G		Corner				F / W / C / O

Comments: ASSOCIATED WITH GLASS BLOCK, 8'x8', REBbed

Inspector: Dane Thompson Inspector: Michael Richter
 AHERA Certificate No.: D9953 State License: EPA AHERA Certificate No.: D10790 State License: EPA
 Signature: [Signature] Date: 03/06/08 Signature: [Signature] Date: 03/06/08

Asbestos-Containing Material: No Yes ASSUMED

SUSPECT ASBESTOS-CONTAINING MATERIAL DESIGNATION AND SAMPLE RECORD FORM



15974 N. 77th Street
 Scottsdale, AZ 85260
 (602) 277-7877
 (602) 277-8288 fax

Project No.: 08-085 Project Name: AHERA Compliance Inspection Owner: Kyrene School District No. 28
 Building No.: Portable 71/72 Address: 14841 S. 41st place
 Campus Name: Kyrene de la Esperanza Phoenix, AZ 85044

Material Code: MCM101 Damaged: Yes No Friable Non-Friable
 General Description: CONCRETE MASONRY UNIT Size: 8"X16"

Matrix/Primary Color: GRAY Texture/Pattern: CEMENTATION Cover/Secondary Color: 8"X8" PATTERN
 Quantity of Material: 400 Estimated By: Drawing Sampled
 Field Measure

Homogeneous Material Location: Ceiling Floor Wall Other

Manner of Sampling: Random Convenience N/A

Sample ID	Sample Location	Points of Origin	East/West Direction	North/South Direction	Height A.F.F.	Surface
A		Corner				F / W / C / O
B		Corner				F / W / C / O
C		Corner				F / W / C / O
D		Corner				F / W / C / O
E		Corner				F / W / C / O
F		Corner				F / W / C / O
G		Corner				F / W / C / O

Comments: _____

Inspector: Dane Thompson Inspector: Michael Richter
 AHERA Certificate No.: D9953 State License: EPA AHERA Certificate No.: D10790 State License: EPA
 Signature: [Signature] Date: 03/06/08 Signature: [Signature] Date: 03/06/08

Asbestos-Containing Material: No Yes ASSUMED

SUSPECT ASBESTOS-CONTAINING MATERIAL DESIGNATION AND SAMPLE RECORD FORM



15974 N. 77th Street
 Scottsdale, AZ 85260
 (602) 277-7877
 (602) 277-8288 fax

FM GROUP/forms/SuspACMDesignRecord.orf

Project No.: 08-085 Project Name: AHERA Compliance Inspection Owner: Kyrene School District No. 28
 Building No.: Portable 71/72 Address: 14841 S. 41st place
 Campus Name: Kyrene de la Esperanza Phoenix, AZ 85044

Material Code: M-MR-OZ Damaged: Yes No Friable Non-Friable
 General Description: MORTAR Size: N/A

Matrix/Primary Color: GRAY Texture/Pattern: CEMENTITIOUS Cover/Secondary Color: N/A
 Quantity of Material: 40 Estimated By: Drawing Field Measure

Homogeneous Material Location: Ceiling Floor Wall Other
 Manner of Sampling: Random Convenience N/A

Sample ID	Sample Location	Points of Origin	East/West Direction	North/South Direction	Height A.F.F.	Surface
A		Corner				F / W / C / O
B		Corner				F / W / C / O
C		Corner				F / W / C / O
D		Corner				F / W / C / O
E		Corner				F / W / C / O
F		Corner				F / W / C / O
G		Corner				F / W / C / O

Comments: ASSOCIATED WITH M'CMU'OI

Inspector: Dane Thompson Inspector: Michael Richter
 AHERA Certificate No.: D9953 State License: EPA AHERA Certificate No.: D10790 State License: EPA
 Signature: [Signature] Date: 03/06/08 Signature: [Signature] Date: 03/06/08

Asbestos-Containing Material: No Yes ASSUMED

SUSPECT ASBESTOS-CONTAINING MATERIAL DESIGNATION AND SAMPLE RECORD FORM



15974 N. 77th Street
 Scottsdale, AZ 85260
 (602) 277-7877
 (602) 277-9288 fax

Project No.: 08-085 Project Name: AHERA Compliance Inspection Owner: Kyrene School District No. 28
 Building No.: Portable 7172 Address: 14841 S. 41st place
 Campus Name: Kyrene de la Esperanza Phoenix, AZ 85044

Material Code: M-CON-03 Damaged: Yes No Friable Non-Friable
 Visible Covered Size: N/A

General Description: CONCRETE (ENTRIES) Texture/Pattern: CEMENT/TI/OAS Cover/Secondary Color: N/A
 Matrix/Primary Color: GRAY Estimated By: Drawing Field Measure
 Quantity of Material: 800 SF / LF / EA

Homogeneous Material Location: Ceiling Floor Wall Other
 Manner of Sampling: Random Convenience N/A

Sample ID	Sample Location	Points of Origin	East/West Direction	North/South Direction	Height A.F.F.	Surface
A		Corner				F / W / C / O
B		Corner				F / W / C / O
C		Corner				F / W / C / O
D		Corner				F / W / C / O
E		Corner				F / W / C / O
F		Corner				F / W / C / O
G		Corner				F / W / C / O

Comments: _____

Inspector: Dane Thompson Inspector: Michael Richter
 AHERA Certificate No.: D9953 State License: EPA AHERA Certificate No.: D10790 State License: EPA
 Signature: [Signature] Date: 03/06/08 Signature: [Signature] Date: 03/06/08

Asbestos-Containing Material: No Yes ASSUMED

SUSPECT ASBESTOS-CONTAINING MATERIAL DESIGNATION AND SAMPLE RECORD FORM



15974 N. 77th Street
 Scottsdale, AZ 85260
 (602) 277-7877
 (602) 277-8288 fax

Project No.: 08-085 Project Name: AHERA Compliance Inspection Owner: Kyrene School District No. 28
 Building No.: Portable 7172 Address: 14841 S. 41st place
 Campus Name: Kyrene de la Esperanza Phoenix, AZ 85044

Material Code: M-BUR-04 Damaged: Yes No Friable Non-Friable
 General Description: BUILT-UP ROOFING Size: N/A

Matrix/Primary Color: BLACK Texture/Pattern: ASPHALTIC Cover/Secondary Color: SPALL MINERAL CAP
 Quantity of Material: 2000 Estimated By: Drawing Field Measure

Homogeneous Material Location: Ceiling Floor Wall Other
 Manner of Sampling: Random Convenience N/A

Sample ID	Sample Location	Points of Origin	East/West Direction	North/South Direction	Height A.F.F.	Surface
A		Corner				F / W / C / O
B		Corner				F / W / C / O
C		Corner				F / W / C / O
D		Corner				F / W / C / O
E		Corner				F / W / C / O
F		Corner				F / W / C / O
G		Corner				F / W / C / O

Comments: _____

Inspector: Dane Thompson Inspector: Michael Richter
 AHERA Certificate No.: D9953 State License: EPA AHERA Certificate No.: D10799 State License: EPA
 Signature: [Signature] Date: 03/06/08 Signature: [Signature] Date: 03/06/08

Asbestos-Containing Material: No Yes ASSUMED

SUSPECT ASBESTOS-CONTAINING MATERIAL DESIGNATION AND SAMPLE RECORD FORM

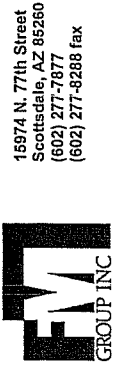

15974 N. 77th Street
 Scottsdale, AZ 85260
 (602) 277-7877
 (602) 277-8288 fax

Project No.: 08-085 Project Name: AHERA Compliance Inspection Owner: Kyrene School District No. 28
 Building No.: Portable 7172 Address: 14841 S. 41st place
 Campus Name: Kyrene de la Esperanza Phoenix, AZ 85044

Material Code: N.A.S.-05 Damaged: Yes No Friable Non-Friable
 General Description: WASTIC (FIBERATIONS AND FLASHINGS) Size: N/A

Matrix/Primary Color: BLACK Texture/Pattern: JAR-LIKE Cover/Secondary Color: N/A
 Quantity of Material: 10 Estimated By: Drawing Field Measure

Homogeneous Material Location: Ceiling Floor Wall Other

Manner of Sampling: Random Convenience N/A

Sample ID	Sample Location	Points of Origin	East/West Direction	North/South Direction	Height A.F.F.	Surface
A		Corner				F / W / C / O
B		Corner				F / W / C / O
C		Corner				F / W / C / O
D		Corner				F / W / C / O
E		Corner				F / W / C / O
F		Corner				F / W / C / O
G		Corner				F / W / C / O

Comments: _____

Inspector: Dane Thompson Inspector: Michael Richter
 AHERA Certificate No.: D9953 State License: EPA AHERA Certificate No.: D10790 State License: EPA
 Signature: [Signature] Date: 03/06/08 Signature: [Signature] Date: 03/06/08

Asbestos-Containing Material: No Yes ASSUMED

SUSPECT ASBESTOS-CONTAINING MATERIAL DESIGNATION AND SAMPLE RECORD FORM



15974 N. 77th Street
 Scottsdale, AZ 85260
 (602) 277-7877
 (602) 277-8288 fax

Project No.: 08-085 Project Name: AHERA Compliance Inspection Owner: Kyrene School District No. 28
 Building No.: Portable 7172 Address: 14841 S. 41st place
 Campus Name: Kyrene de la Esperanza Phoenix, AZ 85044

Material Code: 1. SCS. 010 Damaged: Yes No Friable Non-Friable
 General Description: SEALANT (WINDOWS) Size: N/A

Matrix/Primary Color: BLACK Cover/Secondary Color: N/A
 Quantity of Material: 6 Estimated By: Drawing Sampled Assumed
 Texture/Pattern: Visible Covered SF / LF / EA Drawing Field Measure

Homogeneous Material Location: Ceiling Floor Wall Other
 Manner of Sampling: Random Convenience N/A

Sample ID	Sample Location	Points of Origin	East/West Direction	North/South Direction	Height A.F.F.	Surface
A		Corner				F / W / C / O
B		Corner				F / W / C / O
C		Corner				F / W / C / O
D		Corner				F / W / C / O
E		Corner				F / W / C / O
F		Corner				F / W / C / O
G		Corner				F / W / C / O

Comments:

Inspector: Dane Thompson Inspector: Michael Richter
 AHERA Certificate No.: D9953 State License: EPA AHERA Certificate No.: D10790 State License: EPA
 Signature: _____ Date: 03/06/08 Signature: [Signature] Date: 03/06/08

Asbestos-Containing Material: No Yes ASSUMED

SUSPECT ASBESTOS-CONTAINING MATERIAL DESIGNATION AND SAMPLE RECORD FORM



15974 N. 77th Street
 Scottsdale, AZ 85260
 (602) 277-7877
 (602) 277-8288 fax

Project No.: 08-085 Project Name: AHERA Compliance Inspection Owner: Kyrene School District No. 28
 Building No.: Portable 71/72 Address: 14841 S. 41st place
 Campus Name: Kyrene de la Esperanza Phoenix, AZ 85044

Material Code: M-SLT-07 Damaged: Yes No Friable Non-Friable
 Visible Covered Size: N/A

General Description: SEALANT (DOORS, MILLWORK) Texture/Pattern: FLASK Cover/Secondary Color: N/A
 Matrix/Primary Color: WHITE Quantity of Material: 6 Estimated By: Drawing Field Measure
 Homogeneous Material Location: Ceiling Floor Wall Other

Manner of Sampling: Random Convenience N/A

Sample ID	Sample Location	Points of Origin	East/West Direction	North/South Direction	Height A.F.F.	Surface
A		Corner				F / W / C / O
B		Corner				F / W / C / O
C		Corner				F / W / C / O
D		Corner				F / W / C / O
E		Corner				F / W / C / O
F		Corner				F / W / C / O
G		Corner				F / W / C / O

Comments:

Inspector: Dane Thompson Inspector: Michael Richter
 AHERA Certificate No.: D9953 State License: EPA AHERA Certificate No.: D10790 State License: EPA
 Signature: _____ Date: 03/06/08 Signature: _____ Date: 03/06/08

Asbestos-Containing Material: No Yes ASSUMED

SUSPECT ASBESTOS-CONTAINING MATERIAL DESIGNATION AND SAMPLE RECORD FORM



15974 N. 77th Street
 Scottsdale, AZ 85260
 (602) 277-7877
 (602) 277-8288 fax

Project No.: 08-085 Project Name: AHERA Compliance Inspection Owner: Kyrene School District No. 28
 Building No.: Portable 71/72 Address: 14841 S. 41st place
 Campus Name: Kyrene de la Esperanza Phoenix, AZ 85044

Material Code: M.FD.08 Damaged: Yes No Friable Non-Friable
 General Description: FIRE DOOR INSULATION Size: N/A

Matrix/Primary Color: N/A Texture/Pattern: METAL CLADDING Cover/Secondary Color: N/A
 Quantity of Material: 84 Estimated By: Drawing Field Measure Sampled Assumed

Homogeneous Material Location: Ceiling Floor Wall Other
 Manner of Sampling: Random Convenience N/A

Sample ID	Sample Location	Points of Origin	East/West Direction	North/South Direction	Height A.F.F.	Surface
A		Corner				F / W / O
B		Corner				F / W / O
C		Corner				F / W / O
D		Corner				F / W / C / O
E		Corner				F / W / C / O
F		Corner				F / W / C / O
G		Corner				F / W / C / O

Comments: _____

Inspector: Dane Thompson Inspector: Michael Richter
 AHERA Certificate No.: D9953 State License: EPA AHERA Certificate No.: D10790 State License: EPA
 Signature: [Signature] Date: 03/06/08 Signature: [Signature] Date: 03/06/08

Asbestos-Containing Material: No Yes ASSUMED

SUSPECT ASBESTOS-CONTAINING MATERIAL DESIGNATION AND SAMPLE RECORD FORM

 15974 N. 77th Street
 Scottsdale, AZ 85260
 (602) 277-7877
 (602) 277-8288 fax

Project No.: 08-085 Project Name: AHERA Compliance Inspection Owner: Kyrene School District No. 28
 Building No.: Portable 7172 Address: 14841 S. 41st place
 Campus Name: Kyrene de la Esperanza Phoenix, AZ 85044

Material Code: M-APL-09 Damaged: Yes No Friable Non-Friable
 General Description: ACOUSTICAL CEILING PANEL Size: 2'x4'

Matrix/Primary Color: GRAY Texture/Pattern: PINHOLES AND FISSURES Cover/Secondary Color: WHITE
 Quantity of Material: 2000 Estimated By: Drawing Field Measure

Homogeneous Material Location: Ceiling Floor Wall Other

Manner of Sampling: Random Convenience N/A

Sample ID	Sample Location	Points of Origin	East/West Direction	North/South Direction	Height A.F.F.	Surface
A		NW Corner	ES'	S 4'	8'	F / W / C / O
B		NE Corner	WG'	S 8'	8'	F / W / C / O
C		NW Corner	E 10'	S 10'	8'	F / W / C / O
D		Corner				F / W / C / O
E		Corner				F / W / C / O
F		Corner				F / W / C / O
G		Corner				F / W / C / O

Comments: _____

Inspector: Dane Thompson Inspector: Michael Richter
 AHERA Certificate No.: D9953 State License: EPA AHERA Certificate No.: D10790 State License: EPA
 Signature: [Signature] Date: 03/06/08 Signature: [Signature] Date: 03/06/08

Asbestos-Containing Material: No Yes

SUSPECT ASBESTOS-CONTAINING MATERIAL DESIGNATION AND SAMPLE RECORD FORM



15974 N. 77th Street
 Scottsdale, AZ 85260
 (602) 277-7877
 (602) 277-5288 fax

Project No.: 08-085 Project Name: AHERA Compliance Inspection Owner: Kyrene School District No. 28
 Building No.: Portable 71/72 Address: 14841 S. 41st place
 Campus Name: Kyrene de la Esperanza Phoenix, AZ 85044

Material Code: S-SAT-10 Damaged: Yes No Friable Non-Friable
 General Description: SPRAY-APPLIED TEXTURE Size: N/A

Matrix/Primary Color: WHITE Texture/Pattern: CRACKLY Cover/Secondary Color: N/A
 Quantity of Material: 1500 Estimated By: Drawing Field Measure Sampled Assumed

Homogeneous Material Location: Ceiling Floor Wall Other
 Manner of Sampling: Random Convenience N/A

Sample ID	Sample Location	Points of Origin	East/West Direction	North/South Direction	Height A.F.F.	Surface
A		Corner				F / W / C / O
B		Corner				F / W / C / O
C		Corner				F / W / C / O
D		Corner				F / W / C / O
E		Corner				F / W / C / O
F		Corner				F / W / C / O
G		Corner				F / W / C / O

Comments: _____

Inspector: Dane Thompson Inspector: Michael Richter
 AHERA Certificate No.: D9953 State License: EPA AHERA Certificate No.: D10790 State License: EPA
 Signature: [Signature] Date: 03/06/08 Signature: [Signature] Date: 03/06/08

Asbestos-Containing Material: No Yes ASSUMED

SUSPECT ASBESTOS-CONTAINING MATERIAL DESIGNATION AND SAMPLE RECORD FORM



15974 N. 77th Street
 Scottsdale, AZ 85260
 (602) 277-7877
 (602) 277-8288 fax

Project No.: 08-085 Project Name: AHERA Compliance Inspection Owner: Kyrene School District No. 28
 Building No.: Portable 7172 Address: 14841 S. 41st place
 Campus Name: Kyrene de la Esperanza Phoenix, AZ 85044

Material Code: M.GWB.11 Damaged: Yes No Friable Non-Friable
 Visible Covered SAT Size: N/A

General Description: Gypsum Wall Board Texture/Pattern: Chalky Cover/Secondary Color: N/A
 Matrix/Primary Color: White Estimated By: Drawing Field Measure
 Quantity of Material: 1500 LF / EA Sampling Assumed

Homogeneous Material Location: Ceiling Floor Wall Other
 Manner of Sampling: Random Convenience N/A

Sample ID	Sample Location	Points of Origin	East/West Direction	North/South Direction	Height A.F.F.	Surface
A		Corner				F / W / C / O
B		Corner				F / W / C / O
C		Corner				F / W / C / O
D		Corner				F / W / C / O
E		Corner				F / W / C / O
F		Corner				F / W / C / O
G		Corner				F / W / C / O

Comments: ASSOCIATED WITH S.SAT.10

Inspector: Dane Thompson Michael Richter
 AHERA Certificate No.: D9953 State License: EPA D19790
 Signature: [Signature] Date: 03/06/08

Asbestos-Containing Material: No Yes ASSUMED

SUSPECT ASBESTOS-CONTAINING MATERIAL DESIGNATION AND SAMPLE RECORD FORM

15974 N. 77th Street
 Scottsdale, AZ 85260
 (602) 277-7877
 (602) 277-8288 fax



Project No.: 08-085 Project Name: AHERA Compliance Inspection Owner: Kyrene School District No. 28
 Building No.: Portable 71/72 Address: 14841 S. 41st place
 Campus Name: Kyrene de la Esperanza Phoenix, AZ 85044

Material Code: S-JTC-12 Damaged: Yes No Friable Non-Friable
 General Description: JOINT COMPOUND Visible Covered SAT Size: N/A

Matrix/Primary Color: WHITE Texture/Pattern: CHALKY Cover/Secondary Color: N/A
 Quantity of Material: 150 Estimated By: Drawing Field Measure
 Homogeneous Material Location: Ceiling Floor Wall Other

Manner of Sampling: Random Convenience N/A

Sample ID	Sample Location	Points of Origin	East/West Direction	North/South Direction	Height A.F.F.	Surface
A		Corner				F / W / C / O
B		Corner				F / W / C / O
C		Corner				F / W / C / O
D		Corner				F / W / C / O
E		Corner				F / W / C / O
F		Corner				F / W / C / O
G		Corner				F / W / C / O

Comments: ASSOCIATED WITH M-GWB-11

Inspector: Dane Thompson Inspector: Michael Richter
 AHERA Certificate No.: D9953 State License: EPA AHERA Certificate No.: D10790 State License: EPA
 Signature: [Signature] Date: 03/06/08 Signature: [Signature] Date: 03/06/08

Asbestos-Containing Material: No Yes ASSUMED

SUSPECT ASBESTOS-CONTAINING MATERIAL DESIGNATION AND SAMPLE RECORD FORM



15974 N. 77th Street
 Scottsdale, AZ 85260
 (602) 277-7877
 (602) 277-8288 fax

Project No.: 08-085 Project Name: AHERA Compliance Inspection Owner: Kyrene School District No. 28
 Building No.: Portable 71/72 Address: 14841 S. 41st place
 Campus Name: Kyrene de la Esperanza Phoenix, AZ 85044

Material Code: M.THP.13 Damaged: Yes No Friable Non-Friable
 Visible Covered Size: N/A

General Description: SACKABLE WALL PANEL Cover/Secondary Color: VINYL COVER
 Matrix/Primary Color: BROWN Texture/Pattern: FIBROUS Estimated By: Drawing Field Measure
 Quantity of Material: 1300 SF / LF / EA Drawing Field Measure

Homogeneous Material Location: Ceiling Floor Wall Other
 Manner of Sampling: Random Convenience N/A

Sample ID	Sample Location	Points of Origin	East/West Direction	North/South Direction	Height A.F.F.	Surface
A		Corner				F / W / C / O
B		Corner				F / W / C / O
C		Corner				F / W / C / O
D		Corner				F / W / C / O
E		Corner				F / W / C / O
F		Corner				F / W / C / O
G		Corner				F / W / C / O

Comments: _____

Inspector: Dane Thompson Inspector: Michael Richter
 AHERA Certificate No.: D9953 State License: EPA AHERA Certificate No.: D10790 State License: EPA
 Signature: [Signature] Date: 03/06/08 Signature: [Signature] Date: 03/06/08

Asbestos-Containing Material: No Yes ASSUMED

SUSPECT ASBESTOS-CONTAINING MATERIAL DESIGNATION AND SAMPLE RECORD FORM



15974 N. 77th Street
 Scottsdale, AZ 85260
 (602) 277-7877
 (602) 277-8288 fax

Project No.: 08-085 Project Name: AHERA Compliance Inspection Owner: Kyrene School District No. 28
 Building No.: Portable 71/72 Address: 14841 S. 41st place
 Campus Name: Kyrene de la Esperanza Phoenix, AZ 85044

Material Code: M-SK-14 Damaged: Yes No Friable Non-Friable
 Visible Covered Size: N/A

General Description: SINK ACOUSTICAL CONTAINING Cover/Secondary Color: N/A
 Matrix/Primary Color: BLACK Texture/Pattern: ROUGH Estimated By: Drawing Field Measure
 Quantity of Material: 2 LF / EA Sampling Assumed

Homogeneous Material Location: Ceiling Floor Wall Other
 Manner of Sampling: Random Convenience N/A

Sample ID	Sample Location	Points of Origin	East/West Direction	North/South Direction	Height A.F.F.	Surface
A		Corner				F / W / C / O
B		Corner				F / W / C / O
C		Corner				F / W / C / O
D		Corner				F / W / C / O
E		Corner				F / W / C / O
F		Corner				F / W / C / O
G		Corner				F / W / C / O

Comments: _____

Inspector: Dane Thompson Inspector: Michael Richter
 AHERA Certificate No.: D9953 State License: EPA AHERA Certificate No.: D10790 State License: EPA
 Signature: [Signature] Date: 03/06/08 Signature: [Signature] Date: 03/06/08

Asbestos-Containing Material: No Yes ASSUMED

SUSPECT ASBESTOS-CONTAINING MATERIAL DESIGNATION AND SAMPLE RECORD FORM



15974 N. 77th Street
 Scottsdale, AZ 85260
 (602) 277-7877
 (602) 277-8288 fax

Project No.: 08-085 Project Name: AHERA Compliance Inspection Owner: Kyrene School District No. 28
 Building No.: Portable 71/72 Address: 14841 S. 41st place
 Campus Name: Kyrene de la Esperanza Phoenix, AZ 85044

Material Code: M-SAC-15 Damaged: Yes No Friable Non-Friable
 General Description: SINK ACOUSTICAL COATINGS Size: N/A

Matrix/Primary Color: GRAY Texture/Pattern: ROUGH Cover/Secondary Color: N/A
 Quantity of Material: 2 Estimated By: Drawing Field Measure

Homogeneous Material Location: Ceiling Floor Wall Other

Manner of Sampling: Random Convenience N/A

Sample ID	Sample Location	Points of Origin	East/West Direction	North/South Direction	Height A.F.F.	Surface
A		Corner				F / W / C / O
B		Corner				F / W / C / O
C		Corner				F / W / C / O
D		Corner				F / W / C / O
E		Corner				F / W / C / O
F		Corner				F / W / C / O
G		Corner				F / W / C / O

Comments: _____

Inspector: Dane Thompson Inspector: Michael Richter
 AHERA Certificate No.: D9953 State License: EPA AHERA Certificate No.: D10790 State License: EPA
 Signature: [Signature] Date: 03/06/08 Signature: [Signature] Date: 03/06/08

Asbestos-Containing Material: No Yes ASSUMED

SUSPECT ASBESTOS-CONTAINING MATERIAL DESIGNATION AND SAMPLE RECORD FORM



15974 N. 77th Street
 Scottsdale, AZ 85260
 (602) 277-7877
 (602) 277-8288 fax

Project No.: 08-085 Project Name: AHERA Compliance Inspection Owner: Kyrene School District No. 28
 Building No.: Portable 71/72 Address: 14841 S. 41st place
 Campus Name: Kyrene de la Esperanza Phoenix, AZ 85044

Material Code: M-WAB-10 Damaged: Yes No Friable Non-Friable
 Visible Covered Size: 4"

General Description: WALBASE (COVERED) Texture/Pattern: VINYL-LIKE Cover/Secondary Color: N/A
 Matrix/Primary Color: BLACK Estimated By: Drawing Field Measure
 Quantity of Material: 60 SE / LF / EA Drawing Assumed

Homogeneous Material Location: Ceiling Floor Wall Other
 Manner of Sampling: Random Convenience N/A

Sample ID	Sample Location	Points of Origin	East/West Direction	North/South Direction	Height A.F.F.	Surface
A		Corner				F / W / C / O
B		Corner				F / W / C / O
C		Corner				F / W / C / O
D		Corner				F / W / C / O
E		Corner				F / W / C / O
F		Corner				F / W / C / O
G		Corner				F / W / C / O

Comments: _____

Inspector: Dane Thompson Inspector: Michael Richter
 AHERA Certificate No.: D9953 State License: EPA AHERA Certificate No.: D10790 State License: EPA
 Signature: [Signature] Date: 03/06/08 Signature: [Signature] Date: 03/06/08

Asbestos-Containing Material: No Yes ASSUMED

SUSPECT ASBESTOS-CONTAINING MATERIAL DESIGNATION AND SAMPLE RECORD FORM



15974 N. 77th Street
 Scottsdale, AZ 85260
 (602) 277-7877
 (602) 277-8288 fax

Project No.: 08-085 Project Name: AHERA Compliance Inspection Owner: Kyrene School District No. 28
 Building No.: Portable 71/72 Address: 14841 S. 41st place
 Campus Name: Kyrene de la Esperanza Phoenix, AZ 85044

Material Code: MCADH.17 Damaged: Yes No Friable Non-Friable
 Visible Covered WAS Size: N/A

General Description: ADHESIVE Cover/Secondary Color: N/A
 Matrix/Primary Color: CREAM Texture/Pattern: FLAKE Estimated By: Drawing Field Measure
 Quantity of Material: 60 SF / LF / EA

Homogeneous Material Location: Ceiling Floor Wall Other
 Manner of Sampling: Random Convenience N/A

Sample ID	Sample Location	Points of Origin	East/West Direction	North/South Direction	Height A.F.F.	Surface
A		Corner				F / W / C / O
B		Corner				F / W / C / O
C		Corner				F / W / C / O
D		Corner				F / W / C / O
E		Corner				F / W / C / O
F		Corner				F / W / C / O
G		Corner				F / W / C / O

Comments: ASSOCIATED WITH W-WAIB-16

Inspector: Dane Thompson Inspector: Michael Richter
 AHERA Certificate No.: D9953 State License: EPA AHERA Certificate No.: D10790 State License: EPA
 Signature: [Signature] Date: 03/06/08 Signature: [Signature] Date: 03/06/08

Asbestos-Containing Material: No Yes ASSUMED

SUSPECT ASBESTOS-CONTAINING MATERIAL DESIGNATION AND SAMPLE RECORD FORM



15974 N. 77th Street
 Scottsdale, AZ 85260
 (602) 277-7877
 (602) 277-6288 fax

Project No.: 08-085 Project Name: AHERA Compliance Inspection Owner: Kyrene School District No. 28
 Building No.: Portable 71/72 Address: 14841 S. 41st place
 Campus Name: Kyrene de la Esperanza Phoenix, AZ 85044

Material Code: M-CF-18 Damaged: Yes No Friable Non-Friable
 General Description: CARPET Visible Covered: Size: N/A

Matrix/Primary Color: BLUE Texture/Pattern: FIBROUS Cover/Secondary Color: MULTICOLORED
 Quantity of Material: 2000 Estimated By: Drawing Field Measure Sampled Assumed

Homogeneous Material Location: Ceiling Floor Wall Other
 Manner of Sampling: Random Convenience N/A

Sample ID	Sample Location	Points of Origin	East/West Direction	North/South Direction	Height A.F.F.	Surface
A		Corner				F / W / C / O
B		Corner				F / W / C / O
C		Corner				F / W / C / O
D		Corner				F / W / C / O
E		Corner				F / W / C / O
F		Corner				F / W / C / O
G		Corner				F / W / C / O

Comments: _____

Inspector: Dane Thompson Inspector: Michael Richter
 AHERA Certificate No.: D9953 State License: EPA AHERA Certificate No.: D10790 State License: EPA
 Signature: [Signature] Date: 03/06/08 Signature: [Signature] Date: 03/06/08

Asbestos-Containing Material: No Yes ASSUMED

SUSPECT ASBESTOS-CONTAINING MATERIAL DESIGNATION AND SAMPLE RECORD FORM



15974 N. 77th Street
 Scottsdale, AZ 85260
 (602) 271-7877
 (602) 277-9288 fax

FM GROUP/forms/SuspACMDesignRecord.ornf

Project No.: 08-085 Project Name: AHERA Compliance Inspection Owner: Kyrene School District No. 28
 Building No.: Portable 7172 Address: 14841 S. 41st place
 Campus Name: Kyrene de la Esperanza Phoenix, AZ 85044

Material Code: M-NAS-19 Visible Covered CA
 Damaged: Yes No Friable Non-Friable
 General Description: WASDC Size: N/A

Matrix/Primary Color: YELLOW Texture/Pattern: TACKY Cover/Secondary Color: N/A
 Quantity of Material: 2000 Estimated By: Drawing Field Measure Sampled Assumed

Homogeneous Material Location: Ceiling Floor Wall Other
 Manner of Sampling: Random Convenience N/A

Sample ID	Sample Location	Points of Origin	East/West Direction	North/South Direction	Height A.F.F.	Surface
A		Corner				F / W / C / O
B		Corner				F / W / C / O
C		Corner				F / W / C / O
D		Corner				F / W / C / O
E		Corner				F / W / C / O
F		Corner				F / W / C / O
G		Corner				F / W / C / O

Comments: _____

Inspector: Dane Thompson Inspector: Michael Richter
 AHERA Certificate No.: D9953 State License: EPA AHERA Certificate No.: D40790 State License: EPA
 Signature: [Signature] Date: 03/06/08 Signature: [Signature] Date: 03/06/08

Asbestos-Containing Material: No Yes ASSUMED

SUSPECT ASBESTOS-CONTAINING MATERIAL DESIGNATION AND SAMPLE RECORD FORM



15974 N. 77th Street
 Scottsdale, AZ 85260
 (602) 277-7877
 (602) 277-8288 fax

Project No.: 08-085 Project Name: AHIERA Compliance Inspection Owner: Kyrene School District No. 28
 Building No.: Portable 71/72 Address: 14841 S. 41st place
 Campus Name: Kyrene de la Esperanza Phoenix, AZ 85044

Material Code: M.DSY.20 Damaged: Yes No Friable Non-Friable
 General Description: DUCT SEAM TAPE Size: 4"

Matrix/Primary Color: WHITE Texture/Pattern: Canvas-Like Cover/Secondary Color: N/A
 Quantity of Material: 10 Estimated By: Drawing Field Measure

Homogeneous Material Location: Ceiling Floor Wall Other
 Manner of Sampling: Random Convenience N/A

Sample ID	Sample Location	Points of Origin	East/West Direction	North/South Direction	Height A.F.F.	Surface
A		Corner				F / W / C / O
B		Corner				F / W / C / O
C		Corner				F / W / C / O
D		Corner				F / W / C / O
E		Corner				F / W / C / O
F		Corner				F / W / C / O
G		Corner				F / W / C / O

Comments: _____

Inspector: Dane Thompson Inspector: Michael Richter
 AHIERA Certificate No.: D9953 State License: EPA AHIERA Certificate No.: D40790 State License: EPA
 Signature: [Signature] Date: 03/06/08 Signature: [Signature] Date: 03/06/08

Asbestos-Containing Material: No Yes ASSUMED

SUSPECT ASBESTOS-CONTAINING MATERIAL DESIGNATION AND SAMPLE RECORD FORM



15974 N. 77th Street
 Scottsdale, AZ 85260
 (602) 277-7877
 (602) 277-8288 fax

FM GROUP/forms/SuspACMDesigRecord.0mf

Project No.: 08-085 Project Name: AHERA Compliance Inspection Owner: Kyrene School District No. 28
 Building No.: Portable 73/74 Address: 14841 S. 41st place
 Campus Name: Kyrene de la Esperanza Phoenix, AZ 85044

Material Code: M-LMM-01 Damaged: Yes No Friable Non-Friable
 General Description: CONCRETE MASONRY UNIT Visible Covered Size: 8" x 16"

Matrix/Primary Color: GRAY Texture/Pattern: CEMENTITIOUS Cover/Secondary Color: N/A
 Quantity of Material: 400 Estimated By: Drawing Sampled
 Field Measure Assumed

Homogeneous Material Location: Ceiling Floor Wall Other
 Manner of Sampling: Random Convenience N/A

Sample ID	Sample Location	Points of Origin	East/West Direction	North/South Direction	Height A.F.F.	Surface
A		Corner				F / W / C / O
B		Corner				F / W / C / O
C		Corner				F / W / C / O
D		Corner				F / W / C / O
E		Corner				F / W / C / O
F		Corner				F / W / C / O
G		Corner				F / W / C / O

Comments:

Inspector: Dane Thompson State License: EPA
 AHERA Certificate No.: D9953 State License: EPA
 Signature: [Signature] Date: 03/06/08
 Inspector: Michael Richter State License: EPA
 AHERA Certificate No.: D10790 State License: EPA
 Signature: [Signature] Date: 03/06/08

Asbestos-Containing Material: No Yes ASSUMED

SUSPECT ASBESTOS-CONTAINING MATERIAL DESIGNATION AND SAMPLE RECORD FORM

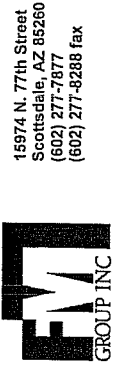

Project No.: 08-085 Project Name: AHERA Compliance Inspection Owner: Kyrene School District No. 28
 Building No.: Portable 73/74 Address: 14841 S. 41st place
 Campus Name: Kyrene de la Esperanza Phoenix, AZ 85044

Material Code: M-MRST-02 Damaged: Yes No Friable Non-Friable
 General Description: ROOFING Size: N/A

Matrix/Primary Color: GRAY Cover/Secondary Color: N/A
 Quantity of Material: 40 Estimated By: Drawing Sampled Assumed
 Homogeneous Material Location: Ceiling Floor Wall Other

Manner of Sampling: Random Convenience N/A

Sample ID	Sample Location	Points of Origin	East/West Direction	North/South Direction	Height A.F.F.	Surface
A		Corner				F / W / C / O
B		Corner				F / W / C / O
C		Corner				F / W / C / O
D		Corner				F / W / C / O
E		Corner				F / W / C / O
F		Corner				F / W / C / O
G		Corner				F / W / C / O

Comments: ASSOCIATED WITH M.C.MULLOY

Inspector: Dane Thompson Inspector: Michael Richter
 AHERA Certificate No.: D9953 State License: EPA AHERA Certificate No.: D10790 State License: EPA
 Signature: [Signature] Date: 03/06/08 Signature: [Signature] Date: 03/06/08

Asbestos-Containing Material: No Yes ASSUMED

SUSPECT ASBESTOS-CONTAINING MATERIAL DESIGNATION AND SAMPLE RECORD FORM

16974 N. 77th Street
 Scottsdale, AZ 85260
 (602) 277-7877
 (602) 277-8288 fax

FM GROUP INC

Project No.: 08-085 Project Name: AHERA Compliance Inspection Owner: Kyrene School District No. 28
 Building No.: Portable 73174 Address: 14841 S. 41st place
 Campus Name: Kyrene de la Esperanza Phoenix, AZ 85044

Material Code: M-CON-03 Damaged: Yes No Friable Non-Friable
 General Description: CONCRETE (ENTRIES) Visible Covered: Size: N/A

Matrix/Primary Color: GRAY Texture/Pattern: CEMENTATIONOUS Cover/Secondary Color: N/A
 Quantity of Material: 800 Estimated By: Drawing Field Measure Sampled Assumed

Homogeneous Material Location: Ceiling Floor Wall Other

Manner of Sampling: Random Convenience N/A

Sample ID	Sample Location	Points of Origin	East/West Direction	North/South Direction	Height A.F.F.	Surface
A		Corner				F / W / C / O
B		Corner				F / W / C / O
C		Corner				F / W / C / O
D		Corner				F / W / C / O
E		Corner				F / W / C / O
F		Corner				F / W / C / O
G		Corner				F / W / C / O

Comments: _____

Inspector: Dane Thompson Inspector: Michael Richter
 AHERA Certificate No.: D9953 State License: EPA AHERA Certificate No.: D10790 State License: EPA
 Signature: [Signature] Date: 03/06/08 Signature: [Signature] Date: 03/06/08

Asbestos-Containing Material: No Yes ASSUMED

SUSPECT ASBESTOS-CONTAINING MATERIAL DESIGNATION AND SAMPLE RECORD FORM



15974 N. 77th Street
 Scottsdale, AZ 85260
 (602) 277-7877
 (602) 277-8288 fax

FM GROUP/forms/SuspACMDesigRecord.ornf

Project No.: 08-085 Project Name: AHERA Compliance Inspection Owner: Kyrene School District No. 28
 Building No.: Portable 73174 Address: 14841 S. 41st place
 Campus Name: Kyrene de la Esperanza Phoenix, AZ 85044

Material Code: MBUR-04 Damaged: Yes No Friable Non-Friable
 Visible Covered Size: N/A

General Description: Built-up Roofing
 Matrix/Primary Color: Black Texture/Pattern: Asphaltic Cover/Secondary Color: Gray Mineral Cap
 Quantity of Material: 2000 Estimated By: Drawing Field Measure
 Homogeneous Material Location: Ceiling Floor Wall Other

Manner of Sampling: Random Convenience N/A

Sample ID	Sample Location	Points of Origin	East/West Direction	North/South Direction	Height A.F.F.	Surface
A		Corner				F / W / C / O
B		Corner				F / W / C / O
C		Corner				F / W / C / O
D		Corner				F / W / C / O
E		Corner				F / W / C / O
F		Corner				F / W / C / O
G		Corner				F / W / C / O

Comments:

Inspector: Dane Thompson State License: EPA AHERA Certificate No.: D9953 State License: EPA
 Signature: [Signature] Date: 03/06/08
 Inspector: Michael Richter State License: EPA AHERA Certificate No.: D0790 State License: EPA
 Signature: [Signature] Date: 03/06/08

Asbestos-Containing Material: No Yes Assumed

SUSPECT ASBESTOS-CONTAINING MATERIAL DESIGNATION AND SAMPLE RECORD FORM

15974 N. 77th Street
 Scottsdale, AZ 85260
 (602) 277-7877
 (602) 277-8288 fax

FM GROUP INC

FM GROUP/forms/SuspACMDesigRecord1.pdf

Project No.: 08-085 Project Name: AHERA Compliance Inspection Owner: Kyrene School District No. 28
 Building No.: Portable 73/74 Address: 14841 S. 41st place
 Campus Name: Kyrene de la Esperanza Phoenix, AZ 85044

Material Code: M.M.A.S.O.S Damaged: Yes No Friable Non-Friable
 General Description: MASTIC (PENETRATIONS AND FLASHINGS) Size: N/A

Matrix/Primary Color: BLACK Texture/Pattern: TAR-LIKE Cover/Secondary Color: N/A
 Quantity of Material: 10 Estimated By: Drawing Field Measure Sampled Assumed

Homogeneous Material Location: Ceiling Floor Wall Other

Manner of Sampling: Random Convenience N/A

Sample ID	Sample Location	Points of Origin	East/West Direction	North/South Direction	Height A.F.F.	Surface
A		Corner				F / W / C / O
B		Corner				F / W / C / O
C		Corner				F / W / C / O
D		Corner				F / W / C / O
E		Corner				F / W / C / O
F		Corner				F / W / C / O
G		Corner				F / W / C / O

Comments:

Inspector: Dane Thompson Inspector: Michael Richter
 AHERA Certificate No.: D9953 State License: EPA AHERA Certificate No.: D10790 State License: EPA
 Signature: *[Signature]* Signature: *[Signature]* Date: 03/06/08 Date: 03/06/08

Asbestos-Containing Material: No Yes ASSUMED

SUSPECT ASBESTOS-CONTAINING MATERIAL DESIGNATION AND SAMPLE RECORD FORM



15974 N. 77th Street
 Scottsdale, AZ 85260
 (602) 277-7877
 (602) 277-8288 fax

Project No.: 08-085 Project Name: AHERA Compliance Inspection Owner: Kyrene School District No. 28
 Building No.: Portable 73/74 Address: 14841 S. 41st place
 Campus Name: Kyrene de la Esperanza Phoenix, AZ 85044

Material Code: M-SLT-06 Damaged: Yes No Friable Non-Friable
 General Description: SEALANT (WINDOWS) Size: n/a
 Matrix/Primary Color: BLACK Texture/Pattern: PLASQUE Cover/Secondary Color: n/a
 Quantity of Material: 6 Estimated By: Drawing Sampled Assumed
 Homogeneous Material Location: Ceiling Floor Wall Other
 Random Convenience N/A

Sample ID	Sample Location	Points of Origin	East/West Direction	North/South Direction	Height A.F.F.	Surface
A		Corner				F / W / C / O
B		Corner				F / W / C / O
C		Corner				F / W / C / O
D		Corner				F / W / C / O
E		Corner				F / W / C / O
F		Corner				F / W / C / O
G		Corner				F / W / C / O

Comments:

Inspector: Dane Thompson State License: EPA AHERA Certificate No.: D9953 Date: 03/06/08
 Inspector: Michael Richter State License: EPA AHERA Certificate No.: D10790 Date: 03/06/08
 Signature: [Signature] Signature: [Signature]

Asbestos-Containing Material: No Yes ASSUMED

SUSPECT ASBESTOS-CONTAINING MATERIAL DESIGNATION AND SAMPLE RECORD FORM

15974 N. 77th Street
 Scottsdale, AZ 85260
 (602) 271-7877
 (602) 277-8288 fax



Project No.: 08-085 Project Name: AHERA Compliance Inspection Owner: Kyrene School District No. 28
 Building No.: Portable 73174 Address: 14841 S. 41st place
 Campus Name: Kyrene de la Esperanza Phoenix, AZ 85044

Material Code: M.SLT.07 Damaged: Yes No Friable Non-Friable
 General Description: SEALANT (DOORS, MILL WORK) Size: N/A

Matrix/Primary Color: WHITE Texture/Pattern: PLIABLE Cover/Secondary Color: N/A
 Quantity of Material: 6 Estimated By: Drawing Sampled Assumed
 Visible Covered No

Homogeneous Material Location: Ceiling Floor Wall Other

Manner of Sampling: Random Convenience N/A

Sample ID	Sample Location	Points of Origin	East/West Direction	North/South Direction	Height A.F.F.	Surface
A		Corner				F / W / C / O
B		Corner				F / W / C / O
C		Corner				F / W / C / O
D		Corner				F / W / C / O
E		Corner				F / W / C / O
F		Corner				F / W / C / O
G		Corner				F / W / C / O

Comments: _____

Inspector: Dane Thompson Inspector: Michael Richter
 AHERA Certificate No.: D9953 State License: EPA AHERA Certificate No.: D10790 State License: EPA
 Signature: [Signature] Date: 03/06/08 Signature: [Signature] Date: 03/06/08

Asbestos-Containing Material: No Yes ASSUMED

SUSPECT ASBESTOS-CONTAINING MATERIAL DESIGNATION AND SAMPLE RECORD FORM



15974 N. 77th Street
 Scottsdale, AZ 85260
 (602) 277-7877
 (602) 277-8288 fax

Project No.: 08-085 Project Name: AHERA Compliance Inspection Owner: Kyrene School District No. 28
 Building No.: Portable 73/74 Address: 14841 S. 41st place
 Campus Name: Kyrene de la Esperanza Phoenix, AZ 85044

Material Code: M.FD1-08 Damaged: Yes No Friable Non-Friable
 General Description: FIRE DOOR INSULATION Size: N/A

Matrix/Primary Color: N/A Texture/Pattern: METAL CLADDING Cover/Secondary Color: N/A
 Quantity of Material: 841 Estimated By: Drawing Field Measure
 Sampled Assumed

Homogeneous Material Location: Ceiling Floor Wall Other
 Manner of Sampling: Random Convenience N/A

Sample ID	Sample Location	Points of Origin	East/West Direction	North/South Direction	Height A.F.F.	Surface
A		Corner				F / W / C / O
B		Corner				F / W / C / O
C		Corner				F / W / C / O
D		Corner				F / W / C / O
E		Corner				F / W / C / O
F		Corner				F / W / C / O
G		Corner				F / W / C / O

Comments: _____

Inspector: Dane Thompson Inspector: Michael Richter
 AHERA Certificate No.: D9953 State License: EPA AHERA Certificate No.: D10790 State License: EPA
 Signature: [Signature] Date: 03/06/08 Signature: [Signature] Date: 03/06/08

Asbestos-Containing Material: No Yes ASSUMED

SUSPECT ASBESTOS-CONTAINING MATERIAL DESIGNATION AND SAMPLE RECORD FORM



15974 N. 77th Street
 Scottsdale, AZ 85260
 (602) 277-7877
 (602) 277-8288 fax

FM GROUP/forms/SuspACMDesignRecord1.mtf

Project No.: 08-085 Project Name: AHERA Compliance Inspection Owner: Kyrene School District No. 28
 Building No.: Portable 73/74 Address: 14841 S. 41st place
 Campus Name: Kyrene de la Esperanza Phoenix, AZ 85044

Material Code: MARL09 Damaged: Yes No Friable Non-Friable
 General Description: ACOUSTICAL CEILING PANEL Size: 2'x4'

Matrix/Primary Color: GRAY Texture/Pattern: PISHOLES AND FISSURES Cover/Secondary Color: WHITE
 Quantity of Material: 2000 Estimated By: Drawing Sampled
 Field Measure

Homogeneous Material Location: Ceiling Floor Wall Other
 Manner of Sampling: Random Convenience N/A

Sample ID	Sample Location	Points of Origin	East/West Direction	North/South Direction	Height A.F.F.	Surface
A		NW Corner	E 5'	S 5'	8'	F/W/C/O
B		NW Corner	E 8'	S 12'	8'	F/W/C/O
C		NE Corner	W 10'	S 8'	8'	F/W/C/O
D		Corner				F/W/C/O
E		Corner				F/W/C/O
F		Corner				F/W/C/O
G		Corner				F/W/C/O

Comments: _____

Inspector: Dane Thompson Inspector: Michael Richter
 AHERA Certificate No.: D9953 State License: EPA AHERA Certificate No.: D10Z90 State License: EPA
 Signature: [Signature] Date: 03/06/08 Signature: [Signature] Date: 03/06/08

Asbestos-Containing Material: No Yes

SUSPECT ASBESTOS-CONTAINING MATERIAL DESIGNATION AND SAMPLE RECORD FORM

 16974 N. 77th Street
 Scottsdale, AZ 85260
 (602) 277-7877
 (602) 277-9288 fax

FM GROUP/forms/SuspACMDesigRecord.oft

Project No.: 08-085 Project Name: AHERA Compliance Inspection Owner: Kyrene School District No. 28
 Building No.: Portable 73/74 Address: 14841 S. 41st place
 Campus Name: Kyrene de la Esperanza Phoenix, AZ 85044

Material Code: S-SAG-10 Damaged: Yes No Friable Non-Friable
 General Description: SPRAY-APPLIED TEXTURE Size: N/A

Matrix/Primary Color: WHITE Texture/Pattern: CRACKLY Cover/Secondary Color: N/A
 Quantity of Material: 1500 Estimated By: Drawing Sampled Assumed
 Homogeneous Material Location: Ceiling Floor Wall Other

Manner of Sampling: Random Convenience N/A

Sample ID	Sample Location	Points of Origin	East/West Direction	North/South Direction	Height A.F.F.	Surface
A		Corner				F / W / C / O
B		Corner				F / W / C / O
C		Corner				F / W / C / O
D		Corner				F / W / C / O
E		Corner				F / W / C / O
F		Corner				F / W / C / O
G		Corner				F / W / C / O

Comments:

Inspector: Dane Thompson Inspector: Michael Richter
 AHERA Certificate No.: D9953 State License: EPA AHERA Certificate No.: D10790 State License: EPA
 Signature: [Signature] Date: 03/06/08 Signature: [Signature] Date: 03/06/08

Asbestos-Containing Material: No Yes ASSUMED

SUSPECT ASBESTOS-CONTAINING MATERIAL DESIGNATION AND SAMPLE RECORD FORM

15974 N. 77th Street
 Scottsdale, AZ 85260
 (602) 277-7877
 (602) 277-8288 fax

FM GROUP INC.

Project No.: 08-085 Project Name: AHERA Compliance Inspection Owner: Kyrene School District No. 28
 Building No.: Portable 73/74 Address: 14841 S. 41st place
 Campus Name: Kyrene de la Esperanza Phoenix, AZ 85044

Material Code: M-GWB-11 Damaged: Yes No Friable Non-Friable
 General Description: Gypsum Wall Board Size: N/A
 Visible Covered SAF

Matrix/Primary Color: White Texture/Pattern: GYALKY Cover/Secondary Color: N/A
 Quantity of Material: 1500 Estimated By: Drawing Field Measure
 SF / LF / EA Drawing Field Measure
 Sampling Random Convenience N/A

Sample ID	Sample Location	Points of Origin	East/West Direction	North/South Direction	Height A.F.F.	Surface
A		Corner				F / W / C / O
B		Corner				F / W / C / O
C		Corner				F / W / C / O
D		Corner				F / W / C / O
E		Corner				F / W / C / O
F		Corner				F / W / C / O
G		Corner				F / W / C / O

Comments: ASSOCIATED WITH SUSPENDED

Inspector: Dane Thompson Inspector: Michael Richter
 AHERA Certificate No.: D9953 State License: EPA AHERA Certificate No.: D10790 State License: EPA
 Signature: [Signature] Date: 03/06/08 Signature: [Signature] Date: 03/06/08

Asbestos-Containing Material: No Yes ASSUMED

SUSPECT ASBESTOS-CONTAINING MATERIAL DESIGNATION AND SAMPLE RECORD FORM

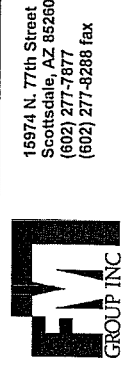

16974 N. 77th Street
 Scottsdale, AZ 85260
 (602) 277-7877
 (602) 277-9288 fax

Project No.: 08-085 Project Name: AHERA Compliance Inspection Owner: Kyrene School District No. 28
 Building No.: Portable 73/74 Address: 14841 S. 41st place
 Campus Name: Kyrene de la Esperanza Phoenix, AZ 85044

Material Code: S.S.C. 12 Damaged: Yes No Friable Non-Friable
 Visible Covered SAT Size: N/A

General Description: JOINT COMPOUND Cover/Secondary Color: N/A
 Matrix/Primary Color: WHITE Texture/Pattern: CHALKY Estimated By: Drawing Field Measure
 Quantity of Material: 150 SF / LF / EA Sampling

Homogeneous Material Location: Ceiling Floor Wall Other
 Manner of Sampling: Random Convenience N/A

Sample ID	Sample Location	Points of Origin	East/West Direction	North/South Direction	Height A.F.F.	Surface
A		Corner				F / W / C / O
B		Corner				F / W / C / O
C		Corner				F / W / C / O
D		Corner				F / W / C / O
E		Corner				F / W / C / O
F		Corner				F / W / C / O
G		Corner				F / W / C / O

Comments: ASSOCIATED WITH M. GUTS. 11

Inspector: Dane Thompson Inspector: Michael Richter
 AHERA Certificate No.: D9953 State License: EPA AHERA Certificate No.: D40790 State License: EPA
 Signature: [Signature] Date: 03/06/08 Signature: [Signature] Date: 03/06/08

Asbestos-Containing Material: No Yes ASSUMED

SUSPECT ASBESTOS-CONTAINING MATERIAL DESIGNATION AND SAMPLE RECORD FORM



15974 N. 77th Street
 Scottsdale, AZ 85260
 (602) 277-7877
 (602) 277-8288 fax

Project No.: 08-085 Project Name: AHERA Compliance Inspection Owner: Kyrene School District No. 28
 Building No.: Portable 73/74 Address: 14841 S. 41st place
 Campus Name: Kyrene de la Esperanza Phoenix, AZ 85044

Material Code: M.TWP-13 Damaged: Yes No Friable Non-Friable
 General Description: TACKABLE WALL PANEL Size: N/A

Matrix/Primary Color: BROWN Texture/Pattern: FIBROUS Cover/Secondary Color: VINYL COVER
 Quantity of Material: 1300 Estimated By: Drawing Sampled
 Field Measure

Homogeneous Material Location: Ceiling Floor Wall Other
 Manner of Sampling: Random Convenience N/A

Sample ID	Sample Location	Points of Origin	East/West Direction	North/South Direction	Height A.F.F.	Surface
A		Corner				F / W / C / O
B		Corner				F / W / C / O
C		Corner				F / W / C / O
D		Corner				F / W / C / O
E		Corner				F / W / C / O
F		Corner				F / W / C / O
G		Corner				F / W / C / O

Comments:

Inspector: Dane Thompson Inspector: Michael Richter
 AHERA Certificate No.: D9953 State License: EPA AHERA Certificate No.: D10790 State License: EPA
 Signature: [Signature] Date: 03/06/08 Signature: [Signature] Date: 03/06/08

Asbestos-Containing Material: No Yes ASSUMED

SUSPECT ASBESTOS-CONTAINING MATERIAL DESIGNATION AND SAMPLE RECORD FORM



15974 N. 77th Street
 Scottsdale, AZ 85260
 (602) 277-7877
 (602) 277-8288 fax

Project No.: 08-085 Project Name: AHERA Compliance Inspection Owner: Kyrene School District No. 28
 Building No.: Portable 73/74 Address: 14841 S. 41st place
 Campus Name: Kyrene de la Esperanza Phoenix, AZ 85044

Material Code: M5AC14 Damaged: Yes No Friable Non-Friable
 General Description: SINK ACOUSTICAL COATING Size: N/A

Matrix/Primary Color: BLACK Texture/Pattern: Rough Cover/Secondary Color: N/A
 Quantity of Material: 2 Estimated By: Drawing Field Measure
 Sampled Assumed

Homogeneous Material Location: Ceiling Floor Wall Other
 Manner of Sampling: Random Convenience N/A

Sample ID	Sample Location	Points of Origin	East/West Direction	North/South Direction	Height A.F.F.	Surface
A		Corner				F / W / C / O
B		Corner				F / W / C / O
C		Corner				F / W / C / O
D		Corner				F / W / C / O
E		Corner				F / W / C / O
F		Corner				F / W / C / O
G		Corner				F / W / C / O

Comments:

Inspector: Dane Thompson State License: EPA AHERA Certificate No.: D9953 Date: 03/06/08
 Inspector: Michael Richter State License: EPA AHERA Certificate No.: D10790 Date: 03/06/08
 Signature: [Signature] Signature: [Signature]

Asbestos-Containing Material: No Yes ASSUMED

SUSPECT ASBESTOS-CONTAINING MATERIAL DESIGNATION AND SAMPLE RECORD FORM

15974 N. 77th Street
 Scottsdale, AZ 85260
 (602) 277-7877
 (602) 277-8288 fax



Project No.: 08-085 Project Name: AHERA Compliance Inspection Owner: Kyrene School District No. 28
 Building No.: Portable 73/74 Address: 14841 S. 41st place
 Campus Name: Kyrene de la Esperanza Phoenix, AZ 85044

Material Code: MWAB-16 Damaged: Yes No Friable Non-Friable
 General Description: WALL BASE (COVERED) Visible Covered Size: 4"

Matrix/Primary Color: BROWN Texture/Pattern: VINYL-LIKE Cover/Secondary Color: N/A
 Quantity of Material: 60 Estimated By: Drawing Field Measure Sampled Assumed

Homogeneous Material Location: Ceiling Floor Wall Other
 Manner of Sampling: Random Convenience N/A

Sample ID	Sample Location	Points of Origin	East/West Direction	North/South Direction	Height A.F.F.	Surface
A		Corner				F / W / C / O
B		Corner				F / W / C / O
C		Corner				F / W / C / O
D		Corner				F / W / C / O
E		Corner				F / W / C / O
F		Corner				F / W / C / O
G		Corner				F / W / C / O

Comments:

Inspector: Dane Thompson Inspector: Michael Richter
 AHERA Certificate No.: D9953 State License: EPA AHERA Certificate No.: D10790 State License: EPA
 Signature: [Signature] Date: 03/06/08 Signature: [Signature] Date: 03/06/08

Asbestos-Containing Material: No Yes ASSUMED

SUSPECT ASBESTOS-CONTAINING MATERIAL DESIGNATION AND SAMPLE RECORD FORM



18974 N. 77th Street
 Scottsdale, AZ 85260
 (602) 277-7877
 (602) 277-8288 fax

FM GROUP/forms/SuspAC/MSigRecord.oft

Project No.: 08-085 Project Name: AHERA Compliance Inspection Owner: Kyrene School District No. 28
 Building No.: Portable 73/74 Address: 14841 S. 41st place
 Campus Name: Kyrene de la Esperanza Phoenix, AZ 85044

Material Code: MADH-17 Damaged: Yes No Friable Non-Friable
 General Description: ADHESIVE Size: N/A

Matrix/Primary Color: CREAM Texture/Pattern: FRIABLE Cover/Secondary Color: N/A
 Quantity of Material: 60 Estimated By: Drawing Field Measure
 Sampled Assumed

Homogeneous Material Location: Ceiling Floor Wall Other
 Manner of Sampling: Random Convenience N/A

Sample ID	Sample Location	Points of Origin	East/West Direction	North/South Direction	Height A.F.F.	Surface
A		Corner				F / W / C / O
B		Corner				F / W / C / O
C		Corner				F / W / C / O
D		Corner				F / W / C / O
E		Corner				F / W / C / O
F		Corner				F / W / C / O
G		Corner				F / W / C / O

Comments: ASSOCIATED WITH M.WAS.24

Inspector: Dane Thompson Inspector: Michael Richter
 AHERA Certificate No.: D9953 State License: EPA AHERA Certificate No.: D10790 State License: EPA
 Signature: [Signature] Date: 03/06/08 Signature: [Signature] Date: 03/06/08

Asbestos-Containing Material: No Yes ASSUMED

SUSPECT ASBESTOS-CONTAINING MATERIAL DESIGNATION AND SAMPLE RECORD FORM



15974 N. 77th Street
 Scottsdale, AZ 85260
 (602) 277-7877
 (602) 277-8288 fax

Project No.: 08-085 Project Name: AHERA Compliance Inspection Owner: Kyrene School District No. 28
 Building No.: Portable 7374 Address: 14841 S. 41st place
 Campus Name: Kyrene de la Esperanza Phoenix, AZ 85044

Material Code: M.C.P.V. 18 Damaged: Yes No Friable Non-Friable
 General Description: CARPET Size: N/A

Matrix/Primary Color: BLUE Texture/Pattern: FIBROUS Cover/Secondary Color: MULTI COLORED
 Quantity of Material: 1500 Estimated By: Drawing Sampled
 Field Measure Assumed

Homogeneous Material Location: Ceiling Floor Wall Other
 Manner of Sampling: Random Convenience N/A

Sample ID	Sample Location	Points of Origin	East/West Direction	North/South Direction	Height A.F.F.	Surface
A		Corner				F / W / C / O
B		Corner				F / W / C / O
C		Corner				F / W / C / O
D		Corner				F / W / C / O
E		Corner				F / W / C / O
F		Corner				F / W / C / O
G		Corner				F / W / C / O

Comments:

Inspector: Dane Thompson Inspector: Michael Richter
 AHERA Certificate No.: D9953 State License: EPA AHERA Certificate No.: D10790 State License: EPA
 Signature: [Signature] Date: 03/06/08 Signature: [Signature] Date: 03/06/08

Asbestos-Containing Material: No Yes ASSUMED

SUSPECT ASBESTOS-CONTAINING MATERIAL DESIGNATION AND SAMPLE RECORD FORM

15974 N. 77th Street
 Scottsdale, AZ 85260
 (602) 277-7877
 (602) 277-8288 fax



FM GROUP/forms/SuspACMDesignRecord1.mxf

Project No.: 08-085 Project Name: AHIERA Compliance Inspection Owner: Kyrene School District No. 28
 Building No.: Portable 73/74 Address: 14841 S. 41st place
 Campus Name: Kyrene de la Esperanza Phoenix, AZ 85044

Material Code: M.MAS.19 Damaged: Yes No Friable Non-Friable
 General Description: MASSTIC Visible Covered CR Size: N/A

Matrix/Primary Color: YELLOW Texture/Pattern: TACKY Cover/Secondary Color: N/A
 Quantity of Material: 1500 Estimated By: Drawing Sampled
 Assumed

Homogeneous Material Location: Ceiling Floor Wall Other
 Manner of Sampling: Random Convenience N/A

Sample ID	Sample Location	Points of Origin	East/West Direction	North/South Direction	Height A.F.F.	Surface
A		Corner				F / W / C / O
B		Corner				F / W / C / O
C		Corner				F / W / C / O
D		Corner				F / W / C / O
E		Corner				F / W / C / O
F		Corner				F / W / C / O
G		Corner				F / W / C / O

Comments: ASSOCIATED WITH M.C.P. 18

Inspector: Dane Thompson Inspector: Michael Richter
 AHRA Certificate No.: D9953 State License: EPA AHRA Certificate No.: D10790 State License: EPA
 Signature: CR Date: 03/06/08 Signature: [Signature] Date: 03/06/08

Asbestos-Containing Material: No Yes ASSUMED

SUSPECT ASBESTOS-CONTAINING MATERIAL DESIGNATION AND SAMPLE RECORD FORM

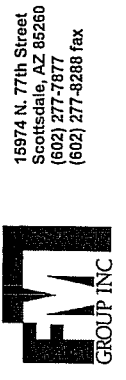

15974 N. 77th Street
 Scottsdale, AZ 85260
 (602) 277-7877
 (602) 277-8288 fax

Project No.: 08-085 Project Name: AHERA Compliance Inspection Owner: Kyrene School District No. 28
 Building No.: Portable 73/74 Address: 14841 S. 41st place
 Campus Name: Kyrene de la Esperanza Phoenix, AZ 85044

Material Code: M.DSF.20 Damaged: Yes No Friable Non-Friable
 General Description: DUCT TAPE Size: N/A

Matrix/Primary Color: WHITE Texture/Pattern: CARBON-LIKE Cover/Secondary Color: N/A
 Quantity of Material: 10 Estimated By: Drawing Sampled
 Field Measure Assumed

Homogeneous Material Location: Ceiling Floor Wall Other
 Manner of Sampling: Random Convenience N/A

Sample ID	Sample Location	Points of Origin	East/West Direction	North/South Direction	Height A.F.F.	Surface
A		Corner				F / W / C / O
B		Corner				F / W / C / O
C		Corner				F / W / C / O
D		Corner				F / W / C / O
E		Corner				F / W / C / O
F		Corner				F / W / C / O
G		Corner				F / W / C / O

Comments:

Inspector: Dane Thompson Inspector: Michael Richter
 AHERA Certificate No.: D9953 State License: EPA AHERA Certificate No.: D10790 State License: EPA
 Signature: CR Date: 03/06/08 Signature: [Signature] Date: 03/06/08

Asbestos-Containing Material: No Yes ASSUMED

SUSPECT ASBESTOS-CONTAINING MATERIAL DESIGNATION AND SAMPLE RECORD FORM



15974 N. 77th Street
 Scottsdale, AZ 85260
 (602) 277-7877
 (602) 277-8288 fax

Project No.: 08-085 Project Name: AHERA Compliance Inspection Owner: Kyrene School District No. 28
 Building No.: Portable 7374 Address: 14841 S. 41st place
 Campus Name: Kyrene de la Esperanza Phoenix, AZ 85044

Material Code: M-VCS-21 Damaged: Yes No Friable Non-Friable
 General Description: VINYL COMPOSITION TILE Size: 12"x12"

Matrix/Primary Color: OFF WHITE Texture/Pattern: SMOOTH Cover/Secondary Color: WHITE MATILES
 Quantity of Material: 250 Estimated By: Drawing Sampled Assumed
 Field Measure

Homogeneous Material Location: Ceiling Floor Wall Other

Manner of Sampling: Random Convenience N/A

Sample ID	Sample Location	Points of Origin	East/West Direction	North/South Direction	Height A.F.F.	Surface
A		Corner				F / W / C / O
B		Corner				F / W / C / O
C		Corner				F / W / C / O
D		Corner				F / W / C / O
E		Corner				F / W / C / O
F		Corner				F / W / C / O
G		Corner				F / W / C / O

Comments:

Inspector: Dane Thompson Inspector: Michael Richter
 AHERA Certificate No.: D9953 State License: EPA AHERA Certificate No.: D10790 State License: EPA
 Signature: [Signature] Date: 03/06/08 Signature: [Signature] Date: 03/06/08

Asbestos-Containing Material: No Yes ASSUMED

SUSPECT ASBESTOS-CONTAINING MATERIAL DESIGNATION AND SAMPLE RECORD FORM



15974 N. 77th Street
 Scottsdale, AZ 85260
 (602) 277-7877
 (602) 277-9288 fax

Project No.: 08-085 Project Name: AHERA Compliance Inspection Owner: Kyrene School District No. 28
 Building No.: Portable 73/74 Address: 14841 S. 41st place
 Campus Name: Kyrene de la Esperanza Phoenix, AZ 85044

Material Code: M.VCS-22 Damaged: Yes No Friable Non-Friable
 General Description: VINYL COMPOSITION TILE Size: 12" x 12"

Matrix/Primary Color: TAN Cover/Secondary Color: TAN MOTILES
 Quantity of Material: 250 Estimated By: Drawing Field Measure
 Homogeneous Material Location: Ceiling Floor Wall Other

Manner of Sampling: Random Convenience N/A

Sample ID	Sample Location	Points of Origin	East/West Direction	North/South Direction	Height A.F.F.	Surface
A		Corner				F / W / C / O
B		Corner				F / W / C / O
C		Corner				F / W / C / O
D		Corner				F / W / C / O
E		Corner				F / W / C / O
F		Corner				F / W / C / O
G		Corner				F / W / C / O

Comments:

Inspector: Dane Thompson State License: EPA AHERA Certificate No.: D9953 Date: 03/06/08
 Inspector: Michael Richter State License: EPA AHERA Certificate No.: D10790 Date: 03/06/08
 Signature: [Signature] Signature: [Signature]

Asbestos-Containing Material: No Yes ASSUMED

SUSPECT ASBESTOS-CONTAINING MATERIAL DESIGNATION AND SAMPLE RECORD FORM



15974 N. 77th Street
 Scottsdale, AZ 85260
 (602) 277-7877
 (602) 277-8288 fax

Project No.: 08-085 Project Name: AHERA Compliance Inspection Owner: Kyrene School District No. 28
 Building No.: Portable 73/74 Address: 14841 S. 41st place
 Campus Name: Kyrene de la Esperanza Phoenix, AZ 85044

Material Code: M.MAS.23 Damaged: Yes No Friable Non-Friable
 General Description: MASTIC Visible Covered Size: N/A

Matrix/Primary Color: YELLOW Texture/Pattern: JACKY Cover/Secondary Color: N/A
 Quantity of Material: 500 Estimated By: Drawing Field Measure
 Homogeneous Material Location: Ceiling Floor Wall Other

Manner of Sampling: Random Convenience N/A

Sample ID	Sample Location	Points of Origin	East/West Direction	North/South Direction	Height A.F.F.	Surface
A		Corner				F / W / C / O
B		Corner				F / W / C / O
C		Corner				F / W / C / O
D		Corner				F / W / C / O
E		Corner				F / W / C / O
F		Corner				F / W / C / O
G		Corner				F / W / C / O

Comments: ASSOCIATED WITH M.V.C.T. 21, M.V.C.T. 22

Inspector: Dane Thompson Inspector: Michael Richter
 AHERA Certificate No.: D9953 State License: EPA AHERA Certificate No.: D10790 State License: EPA
 Signature: [Signature] Date: 03/06/08 Signature: [Signature] Date: 03/06/08

Asbestos-Containing Material: No Yes ASSUMED

SUSPECT ASBESTOS-CONTAINING MATERIAL DESIGNATION AND SAMPLE RECORD FORM



15974 N. 77th Street
 Scottsdale, AZ 85260
 (602) 277-7877
 (602) 277-8288 fax

APPENDIX B

Bulk-Material Sample Documents

- **Chain-of-Custody**
- **Laboratory Analysis**



15974 N. 77th Street
 Scottsdale, AZ 85260
 (602) 277-7877
 (602) 277-8288 fax

chain of custody

1

Date: 03/06/08
 Project No: 08-085
 Initials: MICHAEL RICHTER
 Page: 1 of 3

Job: KURENE DE LA ESPERANZA
 Client: KSD
 Address: 14841 S. 41st PLACE

Test: PLM IS-30
 Rush: Normal: Extended:
 Stop at 1st Positive: WAO
 Read all samples:
 Call with results:
 Fax results:

MAIN BLDG

MATERIAL CODE	MATERIAL DESCRIPTION	MATERIAL SAMPLE NO.	LAYERS**
M.CMU.01	CONCRETE MASONRY UNIT	A-C	S
M.CMU.02	↓		
M.CMU.03	↓		
M.CMU.04	↓		
M.MRT.05	MORTAR		
M.SLT.06	SEALANT		
M.MRT.08	MORTAR		
M.SLT.09	SEALANT		
M.CON.12	CONCRETE		
M.CON.13	↓		
M.CMU.15	CONCRETE MASONRY UNIT		
M.CMU.16	↓		
M.MRT.17	MORTAR		
S.TOT.20	TROWELLED ON TEXTURE	2A	
M.GWB.21	GYPHUM WALL BOARD	2A	
S.JTC.22	JOINT COMPOUND	2A	
M.VCT.23	VINYL COMPOSITION TILE		
M.MAS.24	MASTIC		
M.WAB.25	WALLBASE		
M.ADH.26	ADHESIVE		
S.SAT.29	SPRAC APPLIED TEXTURE	2A	
M.GWB.30	GYPHUM WALL BOARD	2A	

**Sample Layers - M-MULTIPLE, S-SINGLE

RELINQUISHED BY:	DATE:	RECEIVED BY:	DATE:
<u>Michael Richter</u>	<u>3/6/08</u>	<u>K. Lawrence</u>	<u>12:51 3.6.08</u>



15974 N. 77th Street
 Scottsdale, AZ 85260
 (602) 277-7877
 (602) 277-8288 fax

chain of custody

Date: 03/06/08
 Project No: 08-085
 Initials: MICHAEL RICHTER
 Page: 2 of 3

Job: KURENE DE LA ESPERANZA
 Client: KSD
 Address: 14841 S. 41st PLACE

Test: PLM 15-30
 Rush: Normal: Extended: X
 Stop at 1st Positive: X WAD
 Read all samples:
 Call with results:
 Fax results:

MAIN BUDG

MATERIAL CODE	MATERIAL DESCRIPTION	MATERIAL SAMPLE NO.		LAYERS**
S-JTC-31	JOINT COMPOUND	A-C	RA	S
M-SLT-32	SEALANT			
M-CPT-33	CARPET			
M-APL-35	ACOUSTICAL CEILING PANEL		RA	
S-SAT-36	SPRAY APPLIED TEXTURE		RA	
M-GWB-37	GYP SUM WALL BOARD		RA	
S-JTC-38	JOINT COMPOUND		RA	
S-SAT-39	SPRAY APPLIED TEXTURE		RA	
M-GWB-40	GYP SUM WALL BOARD		RA	
S-JTC-41	JOINT COMPOUND		RA	
M-SAC-42	SINK ACOUSTICAL COATING			
M-SLT-43	SEALANT			
M-TWP-45	TACKABLE WALL PANEL			
M-VCT-46	VINYL COMPOSITION TILE			
M-MAS-47	MASTIC			
M-VCT-48	VINYL COMPOSITION TILE			
M-SLT-49	SEALANT			
M-DST-50	DUCT SEAM TAPE		RA	
M-VCT-60	VINYL COMPOSITION TILE			
M-VCT-61	I			
M-VCT-62	I			
M-VCT-63	I			

**Sample Layers - M-MULTIPLE, S-SINGLE

RELINQUISHED BY:	DATE:	RECEIVED BY:	DATE:
<u>Michael Richter</u>	<u>3/6/08</u>	<u>T. Lowman</u>	<u>3-6-08</u>



15974 N. 77th Street
Scottsdale, AZ 85260
(602) 277-7877
(602) 277-8288 fax

chain of custody

Date: 03 / 06 / 08
Project No: 08-085
Initials: MICHAEL RICHTER
Page: 3 of 3

Job: KURENE DE LA ESPERANZA
Client: KSD
Address: 14841 S. 41st PLACE

Test: PLM 15-33
Rush: Normal: Extended:
Stop at 1st Positive: UJO
Read all samples:
Call with results:
Fax results:

MAIN BLDG

MATERIAL CODE	MATERIAL DESCRIPTION	MATERIAL SAMPLE NO.	LAYERS**
M-VCT-04	VINYL COMPOSITION TILE	A-C	S
M-APL-05	ACOUSTICAL CEILING PANEL	I PA	I

**Sample Layers - M-MULTIPLE, S-SINGLE

RELINQUISHED BY:	DATE:	RECEIVED BY:	DATE:
	3/6/08	K Townsend 1251	3-6-08



Polarized Light Microscope (PLM) Analysis for Asbestos

Job Number: 200802110

Client: FM GROUP INC

15974 N 77TH ST

SCOTTSDALE, AZ 85260-0000

Office Phone: (602) 277-7877

FAX: (602) 277-8288

Samples: 138 **PLM Rec:** 3/6/2008 **Method:** EPA 600/R-93/116

PLM analysis for asbestos in bulk smp

Client Job: 08-085/Kyrene De La Esperanza

PO Number: 08-085

Report Date: 4/4/2008

Date Analyzed: 4/3/2008

Routing Number: Michael Richter

Method and Analysis Information: Fiberquant Internal SOP: PLMn

Each bulk sample is first dissected under a 7-30x magnification stereo-microscope. This examination is used to determine the general type of sample, how many and what type of layers it has, and initial estimates of fiber types and quantities. Second, liquid media mounts are made of each layer - such mounts may be of selected fibers (used solely for identification purposes) or may be representative of the layer as a whole (used for quantitation purposes). The mounts may be made in a synthetic Canadian balsam, one of several solvents, or in refractive index oils (media of known refractive index). Generally, a variety of different mounts are made: some optimized for fiber visibility, some optimized for fiber identification, and some optimized for fiber quantitation. The mounted slides are then examined at 50-400x magnification on a Nikon Labphot-pol microscope. Optical characteristics are used to identify each observed fiber type; the optical data are contained for each sample on its detail analysis sheet, attached.

Current EPA, NESHAP and OSHA regulations designate a result of $\leq 1\%$ asbestos as "negative" and $> 1\%$ asbestos as "positive". Samples containing layers that have been determined to be "positive" may have to be handled differently during a renovation or demolition than samples whose layers have been determined to be "negative."

The method of fiber analysis and identification is the EPA Method 600/R-93/116. The method of fiber quantitation is an estimation technique in which the analysts quantitation is routinely calibrated by reference quantitation standards, and which has been shown to be equivalent in precision and accuracy to point counting. Friability is estimated for the purposes of deciding when to point count. Friabilities determined in the field take precedence over those determined in the laboratory. Those sample layers which are friable and estimated by the analyst to contain $\leq 1\%$ asbestos are point counted using 400 points. Such point counting is required by NESHAP (National Emission Standards for Hazardous Air Pollutants, Nov. 1990) in order to rely on analytical results that are $\leq 1\%$. The coefficient of variation for the estimation quantitation technique is 100% in the range 0-5%. This means that PLM analysis is not capable of conclusively determining whether a layer containing close to 1% asbestos is actually "positive" or "negative". For this reason, Fiberquant refers to results where asbestos was detected but $\leq 1\%$ as "borderline negative", and results where asbestos was $> 1\%$ but $\leq 2\%$ as "borderline positive" to indicate the uncertainty in assigning a "positive" or "negative" label. In the sample summary, "ND" means that no asbestos was detected during the analysis. A "Tr" or "Trace" of asbestos reported is defined for our purposes as the detection of several asbestos fibers during the analysis; this level would be right at the limit of detection for the method. Trace is only reported on the analysis detail - in the summary a trace would be reported as $\leq 1\%$. The limit of detection (the smallest % of asbestos that can be detected) varies greatly depending on the matrix in which the asbestos is found. As little as 0.001% asbestos can be detected in favorable samples, while detection in unfavorable samples may approach the detection limit of 1% stated in the method. During the analysis, the analyst, for Fiberquant identification purposes only, determines the "apparent sample type" and "apparent layer types." It must be emphasized that these types are only what is apparent. Often, different materials appear similar or identical after sampling, so the analyst may assign a type other than what was sampled.

Floor tiles present a special problem for PLM asbestos analysis. Floor tile can contain chrysotile fibers so thin that they cannot be resolved by optical methods. In such a case, we may observe a percentage of asbestos which is lower than the actual percentage, or not observe asbestos at all when some is present. For this reason, floor tiles reported as negative should be confirmed to be negative using transmission electron microscope (TEM) analysis. Likewise, vermiculite insulation materials containing traces of asbestiform asbestos present a problem for routine PLM analysis - the amphiboles are sometimes present in trace amounts inhomogeneously distributed. We recommend a hydro-separation technique for such samples.

Vermiculite-containing samples may contain trace amounts of asbestiform amphibole that may or may not be detected during routine PLM analysis. For this reason, loose vermiculite samples reported as negative should be confirmed to contain no amphibole using hydroseparation techniques.

The samples were analyzed under the following ongoing quality assurance program: Blank samples are routinely analyzed to maintain contamination-free materials. Each analyst has at least a bachelor's degree in physical science, and has also completed extensive training specific to asbestos analysis for 1-3 months before being allowed to analyze client samples. Qualitative reference samples are routinely analyzed to assure that analysts can identify asbestos and asbestos-look-alike fibers. Quantitative reference samples are routinely analyzed to calibrate and characterize the estimation procedure. Microscope alignment is checked each day. Refractive index oils are calibrated at least quarterly. At least 10% of client samples are re-analyzed from scratch by a different analyst than the original, and any discrepancies are resolved for the sample and similar sample types before the results are reported. All quality checks performed for these samples were in control except as detailed in the "Analytical Notes" below. All analysts participate in interlab round robins and proficiency testing to assure competence. Fiberquant is accredited by NVLAP (#101031) for the analysis of bulk samples for asbestos using PLM. Accreditation does not imply endorsement by the EPA, any other United States governmental agency or any private agency or association. Each lab analysis refers only to the sample tested, and may not, due to the sampling process, be

representative of the material sampled. This report may not be reproduced except in full, without the approval of Fiberquant Analytical Services.

Some results may have been calculated using client supplied data, such as volume or area sampled, for which Fiberquant assumes no liability for accuracy.

Job Analysis Notes:

Single layer sample and "Analyze Until Positive Found" criteria were followed where requested by the client on the chain of custody.

PLM Analysis Summary:

Job Number: 200802110

08-085/Kyrene De La Esperanza

Sample Number		Lab Number	Apparent Sample Type *	Positive Layer Yes or No
Layer	Color	Apparent Layer Type *	Asbestos Results	
Sample #	M-CMU-01A	2008-02110- 1	Cementitious	Positive Layer? No
Layer # 1	Gray	block	<i>no asbestos detected</i>	
Sample #	M-CMU-01B	2008-02110- 2	Cementitious	Positive Layer? No
Layer # 1	Gray	block	<i>no asbestos detected</i>	
Sample #	M-CMU-01C	2008-02110- 3	Cementitious	Positive Layer? No
Layer # 1	Gray	block	<i>no asbestos detected</i>	
Sample #	M-CMU-02A	2008-02110- 4	Cementitious	Positive Layer? No
Layer # 1	Red	block	<i>no asbestos detected</i>	
Sample #	M-CMU-02B	2008-02110- 5	Cementitious	Positive Layer? No
Layer # 1	Red	block	<i>no asbestos detected</i>	
Sample #	M-CMU-02C	2008-02110- 6	Cementitious	Positive Layer? No
Layer # 1	Red	block	<i>no asbestos detected</i>	
Sample #	M-CMU-03A	2008-02110- 7	Cementitious	Positive Layer? No
Layer # 1	Gray	block	<i>no asbestos detected</i>	
Sample #	M-CMU-03B	2008-02110- 8	Cementitious	Positive Layer? No
Layer # 1	Gray	block	<i>no asbestos detected</i>	
Sample #	M-CMU-03C	2008-02110- 9	Cementitious	Positive Layer? No
Layer # 1	Gray	block	<i>no asbestos detected</i>	
Sample #	M-CMU-04A	2008-02110- 10	Cementitious	Positive Layer? No
Layer # 1	Gray	block	<i>no asbestos detected</i>	
Sample #	M-CMU-04B	2008-02110- 11	Cementitious	Positive Layer? No
Layer # 1	Gray	block	<i>no asbestos detected</i>	
Sample #	M-CMU-04C	2008-02110- 12	Cementitious	Positive Layer? No
Layer # 1	Gray	block	<i>no asbestos detected</i>	
Sample #	M-MRT-05A	2008-02110- 13	Cementitious	Positive Layer? No
Layer # 1	Gray	mortar	<i>no asbestos detected</i>	
Sample #	M-MRT-05B	2008-02110- 14	Cementitious	Positive Layer? No
Layer # 1	Gray	mortar	<i>no asbestos detected</i>	
Sample #	M-MRT-05C	2008-02110- 15	Cementitious	Positive Layer? No
Layer # 1	Gray	mortar	<i>no asbestos detected</i>	
Sample #	M-SLT-06A	2008-02110- 16	Adhesive/caulk	Positive Layer? No
Layer # 1	Gray	sealant	<i>no asbestos detected</i>	
Sample #	M-SLT-06B	2008-02110- 17	Adhesive/caulk	Positive Layer? No
Layer # 1	Gray	sealant	<i>no asbestos detected</i>	
Sample #	M-SLT-06C	2008-02110- 18	Adhesive/caulk	Positive Layer? No
Layer # 1	Gray	sealant	<i>no asbestos detected</i>	
Sample #	M-MRT-08A	2008-02110- 19	Cementitious	Positive Layer? No
Layer # 1	White	mortar	<i>no asbestos detected</i>	
Sample #	M-MRT-08B	2008-02110- 20	Cementitious	Positive Layer? No
Layer # 1	White	mortar	<i>no asbestos detected</i>	
Sample #	M-MRT-08C	2008-02110- 21	Cementitious	Positive Layer? No
Layer # 1	White	mortar	<i>no asbestos detected</i>	
Sample #	M-SLT-09A	2008-02110- 22	Adhesive/caulk	Positive Layer? No
Layer # 1	White	sealant	<i>no asbestos detected</i>	
Sample #	M-SLT-09B	2008-02110- 23	Adhesive/caulk	Positive Layer? No
Layer # 1	White	sealant	<i>no asbestos detected</i>	
Sample #	M-SLT-09C	2008-02110- 24	Adhesive/caulk	Positive Layer? No
Layer # 1	White	sealant	<i>no asbestos detected</i>	
Sample #	M-CON-12A	2008-02110- 25	Cementitious	Positive Layer? No
Layer # 1	gray	concrete	<i>no asbestos detected</i>	
Sample #	M-CON-12B	2008-02110- 26	Cementitious	Positive Layer? No
Layer # 1	gray	concrete	<i>no asbestos detected</i>	
Sample #	M-CON-12C	2008-02110- 27	Cementitious	Positive Layer? No
Layer # 1	gray	concrete	<i>no asbestos detected</i>	
Sample #	M-CON-13A	2008-02110- 28	Cementitious	Positive Layer? No
Layer # 1	gray	concrete	<i>no asbestos detected</i>	
Sample #	M-CON-13B	2008-02110- 29	Cementitious	Positive Layer? No
Layer # 1	gray	concrete	<i>no asbestos detected</i>	
Sample #	M-CON-13C	2008-02110- 30	Cementitious	Positive Layer? No
Layer # 1	gray	concrete	<i>no asbestos detected</i>	

Sample #	M-CMU-15A	2008-02110- 31	Cementitious	Positive Layer? No
Layer # 1	Gray	block	<i>no asbestos detected</i>	
Sample #	M-CMU-15B	2008-02110- 32	Cementitious	Positive Layer? No
Layer # 1	Gray	block	<i>no asbestos detected</i>	
Sample #	M-CMU-15C	2008-02110- 33	Cementitious	Positive Layer? No
Layer # 1	Gray	block	<i>no asbestos detected</i>	
Sample #	M-CMU-16A	2008-02110- 34	Cementitious	Positive Layer? No
Layer # 1	Gray	block	<i>no asbestos detected</i>	
Sample #	M-CMU-16B	2008-02110- 35	Cementitious	Positive Layer? No
Layer # 1	Gray	block	<i>no asbestos detected</i>	
Sample #	M-CMU-16C	2008-02110- 36	Cementitious	Positive Layer? No
Layer # 1	Gray	block	<i>no asbestos detected</i>	
Sample #	M-MRT-17A	2008-02110- 37	Cementitious	Positive Layer? No
Layer # 1	Gray	mortar	<i>no asbestos detected</i>	
Sample #	M-MRT-17B	2008-02110- 38	Cementitious	Positive Layer? No
Layer # 1	Gray	mortar	<i>no asbestos detected</i>	
Sample #	M-MRT-17C	2008-02110- 39	Cementitious	Positive Layer? No
Layer # 1	Gray	mortar	<i>no asbestos detected</i>	
Sample #	S-TOT-20A	2008-02110- 40	Wall System	Positive Layer? No
Layer # 1	white	texture/joint compound	<i>no asbestos detected</i>	
Sample #	S-TOT-20B	2008-02110- 41	Wall System	Positive Layer? No
Layer # 1	white	texture/joint compound	<i>no asbestos detected</i>	
Sample #	S-TOT-20C	2008-02110- 42	Wall System	Positive Layer? No
Layer # 1	white	texture/joint compound	<i>no asbestos detected</i>	
Sample #	M-GWB-21A	2008-02110- 43	Wall System	Positive Layer? No
Layer # 1	white	drywall core	<i>no asbestos detected</i>	
Sample #	M-GWB-21B	2008-02110- 44	Wall System	Positive Layer? No
Layer # 1	white	drywall core	<i>no asbestos detected</i>	
Sample #	M-GWB-21C	2008-02110- 45	Wall System	Positive Layer? No
Layer # 1	white	drywall core	<i>no asbestos detected</i>	
Sample #	S-JTC-22A	2008-02110- 46	Wall System	Positive Layer? No
Layer # 1	white	texture/joint compound	<i>no asbestos detected</i>	
Sample #	S-JTC-22B	2008-02110- 47	Wall System	Positive Layer? No
Layer # 1	white	texture/joint compound	<i>no asbestos detected</i>	
Sample #	S-JTC-22C	2008-02110- 48	Wall System	Positive Layer? No
Layer # 1	white	texture/joint compound	<i>no asbestos detected</i>	
Sample #	M-VCT-23A	2008-02110- 49	Flooring	Positive Layer? No
Layer # 1	off-white	floor tile	<i>no asbestos detected</i>	
Sample #	M-VCT-23B	2008-02110- 50	Flooring	Positive Layer? No
Layer # 1	off-white	floor tile	<i>no asbestos detected</i>	
Sample #	M-VCT-23C	2008-02110- 51	Flooring	Positive Layer? No
Layer # 1	off-white	floor tile	<i>no asbestos detected</i>	
Sample #	M-MAS-24A	2008-02110- 52	Adhesive/caulk	Positive Layer? No
Layer # 1	tan	mastic	<i>no asbestos detected</i>	
Sample #	M-MAS-24B	2008-02110- 53	Adhesive/caulk	Positive Layer? No
Layer # 1	tan	mastic	<i>no asbestos detected</i>	
Sample #	M-MAS-24C	2008-02110- 54	Adhesive/caulk	Positive Layer? No
Layer # 1	tan	mastic	<i>no asbestos detected</i>	
Sample #	M-WAB-25A	2008-02110- 55	Miscellaneous	Positive Layer? No
Layer # 1	Blue	base cove	<i>no asbestos detected</i>	
Sample #	M-WAB-25B	2008-02110- 56	Miscellaneous	Positive Layer? No
Layer # 1	Blue	base cove	<i>no asbestos detected</i>	
Sample #	M-WAB-25C	2008-02110- 57	Miscellaneous	Positive Layer? No
Layer # 1	Blue	base cove	<i>no asbestos detected</i>	
Sample #	M-ADH-26A	2008-02110- 58	Adhesive/caulk	Positive Layer? No
Layer # 1	Off-white	mastic	<i>no asbestos detected</i>	
Sample #	M-ADH-26B	2008-02110- 59	Adhesive/caulk	Positive Layer? No
Layer # 1	Off-white	mastic	<i>no asbestos detected</i>	
Sample #	M-ADH-26C	2008-02110- 60	Adhesive/caulk	Positive Layer? No
Layer # 1	Off-white	mastic	<i>no asbestos detected</i>	
Sample #	S-SAT-29A	2008-02110- 61	Wall System	Positive Layer? No
Layer # 1	white	texture/joint compound	<i>no asbestos detected</i>	
Sample #	S-SAT-29B	2008-02110- 62	Wall System	Positive Layer? No
Layer # 1	white	texture/joint compound	<i>no asbestos detected</i>	
Sample #	S-SAT-29C	2008-02110- 63	Wall System	Positive Layer? No
Layer # 1	white	texture/joint compound	<i>no asbestos detected</i>	
Sample #	M-GWB-30A	2008-02110- 64	Wall System	Positive Layer? No
Layer # 1	Tan	drywall core	<i>no asbestos detected</i>	
Sample #	M-GWB-30B	2008-02110- 65	Wall System	Positive Layer? No
Layer # 1	Tan	drywall core	<i>no asbestos detected</i>	
Sample #	M-GWB-30C	2008-02110- 66	Wall System	Positive Layer? No
Layer # 1	Tan	drywall core	<i>no asbestos detected</i>	
Sample #	S-JTC-31A	2008-02110- 67	Wall System	Positive Layer? No
Layer # 1	white	texture/joint compound	<i>no asbestos detected</i>	

Sample # S-JTC-31B Layer # 1 white	2008-02110- 68	Wall System texture/joint compound	<i>no asbestos detected</i>	Positive Layer? No
Sample # S-JTC-31C Layer # 1 white	2008-02110- 69	Wall System texture/joint compound	<i>no asbestos detected</i>	Positive Layer? No
Sample # M-SLT-32A Layer # 1 white	2008-02110- 70	Adhesive/caulk caulk	<i>no asbestos detected</i>	Positive Layer? No
Sample # M-SLT-32B Layer # 1 white	2008-02110- 71	Adhesive/caulk caulk	<i>no asbestos detected</i>	Positive Layer? No
Sample # M-SLT-32C Layer # 1 white	2008-02110- 72	Adhesive/caulk caulk	<i>no asbestos detected</i>	Positive Layer? No
Sample # M-CPT-33A Layer # 1 various	2008-02110- 73	Carpet carpet	<i>no asbestos detected</i>	Positive Layer? No
Sample # M-CPT-33B Layer # 1 various	2008-02110- 74	Carpet carpet	<i>no asbestos detected</i>	Positive Layer? No
Sample # M-CPT-33C Layer # 1 various	2008-02110- 75	Carpet carpet	<i>no asbestos detected</i>	Positive Layer? No
Sample # M-APL-35A Layer # 1 Tan	2008-02110- 76	Ceiling Tile ceiling tile	<i>no asbestos detected</i>	Positive Layer? No
Sample # M-APL-35B Layer # 1 Tan	2008-02110- 77	Ceiling Tile ceiling tile	<i>no asbestos detected</i>	Positive Layer? No
Sample # M-APL-35C Layer # 1 Tan	2008-02110- 78	Ceiling Tile ceiling tile	<i>no asbestos detected</i>	Positive Layer? No
Sample # S-SAT-36A Layer # 1 white	2008-02110- 79	Wall System texture/joint compound	<i>no asbestos detected</i>	Positive Layer? No
Sample # S-SAT-36B Layer # 1 white	2008-02110- 80	Wall System texture/joint compound	<i>no asbestos detected</i>	Positive Layer? No
Sample # S-SAT-36C Layer # 1 white	2008-02110- 81	Wall System texture/joint compound	<i>no asbestos detected</i>	Positive Layer? No
Sample # M-GWB-37A Layer # 1 white	2008-02110- 82	Wall System drywall core	<i>no asbestos detected</i>	Positive Layer? No
Sample # M-GWB-37B Layer # 1 white	2008-02110- 83	Wall System drywall core	<i>no asbestos detected</i>	Positive Layer? No
Sample # M-GWB-37C Layer # 1 white	2008-02110- 84	Wall System drywall core	<i>no asbestos detected</i>	Positive Layer? No
Sample # S-JTC-38A Layer # 1 white	2008-02110- 85	Wall System texture/joint compound	<i>no asbestos detected</i>	Positive Layer? No
Sample # S-JTC-38B Layer # 1 white	2008-02110- 86	Wall System texture/joint compound	<i>no asbestos detected</i>	Positive Layer? No
Sample # S-JTC-38C Layer # 1 white	2008-02110- 87	Wall System texture/joint compound	<i>no asbestos detected</i>	Positive Layer? No
Sample # S-SAT-39A Layer # 1 white	2008-02110- 88	Wall System texture/joint compound	<i>no asbestos detected</i>	Positive Layer? No
Sample # S-SAT-39B Layer # 1 white	2008-02110- 89	Wall System texture/joint compound	<i>no asbestos detected</i>	Positive Layer? No
Sample # S-SAT-39C Layer # 1 white	2008-02110- 90	Wall System texture/joint compound	<i>no asbestos detected</i>	Positive Layer? No
Sample # M-GWB-40A Layer # 1 white	2008-02110- 91	Wall System drywall core	<i>no asbestos detected</i>	Positive Layer? No
Sample # M-GWB-40B Layer # 1 white	2008-02110- 92	Wall System drywall core	<i>no asbestos detected</i>	Positive Layer? No
Sample # M-GWB-40C Layer # 1 white	2008-02110- 93	Wall System drywall core	<i>no asbestos detected</i>	Positive Layer? No
Sample # S-JTC-41A Layer # 1 white	2008-02110- 94	Wall System texture/joint compound	<i>no asbestos detected</i>	Positive Layer? No
Sample # S-JTC-41B Layer # 1 white	2008-02110- 95	Wall System texture/joint compound	<i>no asbestos detected</i>	Positive Layer? No
Sample # S-JTC-41C Layer # 1 white	2008-02110- 96	Wall System texture/joint compound	<i>no asbestos detected</i>	Positive Layer? No
Sample # M-SAC-42A Layer # 1 Gray	2008-02110- 97	Miscellaneous coating	<i>no asbestos detected</i>	Positive Layer? No
Sample # M-SAC-42B Layer # 1 Gray	2008-02110- 98	Miscellaneous coating	<i>no asbestos detected</i>	Positive Layer? No
Sample # M-SAC-42C Layer # 1 Gray	2008-02110- 99	Miscellaneous coating	<i>no asbestos detected</i>	Positive Layer? No
Sample # M-SLT-43A Layer # 1 Black Layer # 2 Yellow	2008-02110- 100	Adhesive/caulk sealant sealant	<i>no asbestos detected</i> <i>no asbestos detected</i>	Positive Layer? No
Sample # M-SLT-43B Layer # 1 Black	2008-02110- 101	Adhesive/caulk sealant	<i>no asbestos detected</i>	Positive Layer? No
Sample # M-SLT-43C Layer # 1 Black	2008-02110- 102	Adhesive/caulk sealant	<i>no asbestos detected</i>	Positive Layer? No
Sample # M-TWP-45A Layer # 1 Tan	2008-02110- 103	Acoustic Tile panel	<i>no asbestos detected</i>	Positive Layer? No
Sample # M-TWP-45B Layer # 1 Tan	2008-02110- 104	Acoustic Tile panel	<i>no asbestos detected</i>	Positive Layer? No

Sample # M-TWP-45C Layer # 1 Tan	panel	2008-02110- 105 Acoustic Tile <i>no asbestos detected</i>	Positive Layer? No
Sample # M-VCT-46A Layer # 1 Blue	floor tile	2008-02110- 106 Flooring <i>no asbestos detected</i>	Positive Layer? No
Sample # M-VCT-46B Layer # 1 Blue	floor tile	2008-02110- 107 Flooring <i>no asbestos detected</i>	Positive Layer? No
Sample # M-VCT-46C Layer # 1 Blue	floor tile	2008-02110- 108 Flooring <i>no asbestos detected</i>	Positive Layer? No
Sample # M-MAS-47A Layer # 1 Off-white	mastic	2008-02110- 109 Adhesive/caulk <i>no asbestos detected</i>	Positive Layer? No
Sample # M-MAS-47B Layer # 1 Off-white	mastic	2008-02110- 110 Adhesive/caulk <i>no asbestos detected</i>	Positive Layer? No
Sample # M-MAS-47C Layer # 1 Off-white	mastic	2008-02110- 111 Adhesive/caulk <i>no asbestos detected</i>	Positive Layer? No
Sample # M-VCT-48A Layer # 1 Pink	floor tile	2008-02110- 112 Flooring <i>no asbestos detected</i>	Positive Layer? No
Sample # M-VCT-48B Layer # 1 Pink	floor tile	2008-02110- 113 Flooring <i>no asbestos detected</i>	Positive Layer? No
Sample # M-VCT-48C Layer # 1 Pink	floor tile	2008-02110- 114 Flooring <i>no asbestos detected</i>	Positive Layer? No
Sample # M-SLT-49A Layer # 1 white	caulk	2008-02110- 115 Adhesive/caulk <i>no asbestos detected</i>	Positive Layer? No
Sample # M-SLT-49B Layer # 1 white	caulk	2008-02110- 116 Adhesive/caulk <i>no asbestos detected</i>	Positive Layer? No
Sample # M-SLT-49C Layer # 1 white	caulk	2008-02110- 117 Adhesive/caulk <i>no asbestos detected</i>	Positive Layer? No
Sample # M-DST-50A Layer # 1 White	duct tape	2008-02110- 118 TSI <i>no asbestos detected</i>	Positive Layer? No
Sample # M-DST-50B Layer # 1 White	duct tape	2008-02110- 119 TSI <i>no asbestos detected</i>	Positive Layer? No
Sample # M-DST-50C Layer # 1 White	duct tape	2008-02110- 120 TSI <i>no asbestos detected</i>	Positive Layer? No
Sample # M-VCT-60A Layer # 1 Orange	floor tile	2008-02110- 121 Flooring <i>no asbestos detected</i>	Positive Layer? No
Sample # M-VCT-60B Layer # 1 Orange	floor tile	2008-02110- 122 Flooring <i>no asbestos detected</i>	Positive Layer? No
Sample # M-VCT-60C Layer # 1 Orange	floor tile	2008-02110- 123 Flooring <i>no asbestos detected</i>	Positive Layer? No
Sample # M-VCT-61A Layer # 1 Blue	floor tile	2008-02110- 124 Flooring <i>no asbestos detected</i>	Positive Layer? No
Sample # M-VCT-61B Layer # 1 Blue	floor tile	2008-02110- 125 Flooring <i>no asbestos detected</i>	Positive Layer? No
Sample # M-VCT-61C Layer # 1 Blue	floor tile	2008-02110- 126 Flooring <i>no asbestos detected</i>	Positive Layer? No
Sample # M-VCT-62A Layer # 1 Various	floor tile	2008-02110- 127 Flooring <i>no asbestos detected</i>	Positive Layer? No
Sample # M-VCT-62B Layer # 1 Various	floor tile	2008-02110- 128 Flooring <i>no asbestos detected</i>	Positive Layer? No
Sample # M-VCT-62C Layer # 1 Various	floor tile	2008-02110- 129 Flooring <i>no asbestos detected</i>	Positive Layer? No
Sample # M-VCT-63A Layer # 1 Various	floor tile	2008-02110- 130 Flooring <i>no asbestos detected</i>	Positive Layer? No
Sample # M-VCT-63B Layer # 1 Various	floor tile	2008-02110- 131 Flooring <i>no asbestos detected</i>	Positive Layer? No
Sample # M-VCT-63C Layer # 1 Various	floor tile	2008-02110- 132 Flooring <i>no asbestos detected</i>	Positive Layer? No
Sample # M-VCT-64A Layer # 1 Various	floor tile	2008-02110- 133 Flooring <i>no asbestos detected</i>	Positive Layer? No
Sample # M-VCT-64B Layer # 1 Various	floor tile	2008-02110- 134 Flooring <i>no asbestos detected</i>	Positive Layer? No
Sample # M-VCT-64C Layer # 1 Various	floor tile	2008-02110- 135 Flooring <i>no asbestos detected</i>	Positive Layer? No
Sample # M-APL-65A Layer # 1 White	panel	2008-02110- 136 Acoustic Tile <i>no asbestos detected</i>	Positive Layer? No
Sample # M-APL-65B Layer # 1 White	panel	2008-02110- 137 Acoustic Tile <i>no asbestos detected</i>	Positive Layer? No
Sample # M-APL-65C Layer # 1 White	panel	2008-02110- 138 Acoustic Tile <i>no asbestos detected</i>	Positive Layer? No

* Apparent Sample Types and Apparent Layer Types are as they appeared to the analyst. Since many types of materials appear similar after sampling damage, the apparent type of material may not be the actual type of material.

PLM Analysis Details

Job Number: 200802110

08-085/Kyrene De La Esperanza

Sample M-CMU-01A **Lab Number** 2008-02110-1 **Sampled:** 3/6/2008 **Condition:** acceptable
Analyzed By LSP 4/3/2008 **An?** OK **Apparent Smp Type** Cementitious **Non-fibrous Solid**
Homogeneous Yes **# Layers** 1 **Pos Layer?** No **# Sub-Samples** 3
Non-Fibrous Components (in approx. decreasing order): powder, rock,

Layers					Percents of Each Fiber					
#	Layer Type	%	Color	Friability	Fib 1	Fib 2	Fib 3	Fib 4	Fib 5	Fib 6
1	block	100	Gray	1	n.d.	-	-	-	-	-
Total %		100	Average %		n.d.	-	-	-	-	-
Fiber Identification: none										

Fibers									Refractive Index Determinations				
#	Color	Mrph	Iso	Pleo	Bi	Elg	Ext	Oil	Col Par	Col Per	RI Par	RI Per	
1	none												
2													
3													
4													
5													
6													

Sample Analytical Note

Procedure: tweased apart using forceps. Procedure: dissolution of matrix using dilute HCl acid.

Sample M-CMU-01B **Lab Number** 2008-02110-2 **Sampled:** 3/6/2008 **Condition:** acceptable
Analyzed By LSP 4/3/2008 **An?** OK **Apparent Smp Type** Cementitious **Non-fibrous Solid**
Homogeneous Yes **# Layers** 1 **Pos Layer?** No **# Sub-Samples** 3
Non-Fibrous Components (in approx. decreasing order): powder, rock,

Layers					Percents of Each Fiber					
#	Layer Type	%	Color	Friability	Fib 1	Fib 2	Fib 3	Fib 4	Fib 5	Fib 6
1	block	100	Gray	1	n.d.	-	-	-	-	-
Total %		100	Average %		n.d.	-	-	-	-	-
Fiber Identification: none										

Fibers									Refractive Index Determinations				
#	Color	Mrph	Iso	Pleo	Bi	Elg	Ext	Oil	Col Par	Col Per	RI Par	RI Per	
1	none												
2													
3													
4													
5													
6													

Sample Analytical Note

Procedure: tweased apart using forceps. Procedure: dissolution of matrix using dilute HCl acid.

Sample M-CMU-01C **Lab Number** 2008-02110-3 **Sampled:** 3/6/2008 **Condition:** acceptable
Analyzed By LSP 4/3/2008 **An?** OK **Apparent Smp Type** Cementitious **Non-fibrous Solid**
Homogeneous Yes **# Layers** 1 **Pos Layer?** No **# Sub-Samples** 3
Non-Fibrous Components (in approx. decreasing order): powder, rock,

Layers					Percents of Each Fiber					
#	Layer Type	%	Color	Friability	Fib 1	Fib 2	Fib 3	Fib 4	Fib 5	Fib 6
1	block	100	Gray	1	n.d.	-	-	-	-	-
Total %		100	Average %		n.d.	-	-	-	-	-
Fiber Identification: none										

Fibers									Refractive Index Determinations				
#	Color	Mrph	Iso	Pleo	Bi	Elg	Ext	Oil	Col Par	Col Per	RI Par	RI Per	
1	none												
2													
3													
4													
5													
6													

Sample Analytical Note

Procedure: tweased apart using forceps. Procedure: dissolution of matrix using dilute HCl acid.

PLM Analysis Details

Job Number: 200802110

08-085/Kyrene De La Esperanza

Sample M-CMU-02A **Lab Number** 2008-02110- 4 **Sampled:** 3/6/2008 **Condition:** acceptable
Analyzed By LSP 4/3/2008 **An?** OK **Apparent Smp Type** Cementitious Non-fibrous Solid
Homogeneous Yes **# Layers** 1 **Pos Layer?** No **# Sub-Samples** 3
Non-Fibrous Components (in approx. decreasing order): powder, rock,

Layers					Percents of Each Fiber					
#	Layer Type	%	Color	Friability	Fib 1	Fib 2	Fib 3	Fib 4	Fib 5	Fib 6
1	block	100	Red	1	n.d.	-	-	-	-	-
Total %		100	Average %		n.d.	-	-	-	-	-
Fiber Identification:					none					

Fibers									Refractive Index Determinations				
#	Color	Mrph	Iso	Pleo	Bi	Elg	Ext	Oil	Col Par	Col Per	RI Par	RI Per	
1	none												
2													
3													
4													
5													
6													

Sample Analytical Note
 Procedure: tweased apart using forceps. Procedure: dissolution of matrix using dilute HCl acid.

Sample M-CMU-02B **Lab Number** 2008-02110- 5 **Sampled:** 3/6/2008 **Condition:** acceptable
Analyzed By LSP 4/3/2008 **An?** OK **Apparent Smp Type** Cementitious Non-fibrous Solid
Homogeneous Yes **# Layers** 1 **Pos Layer?** No **# Sub-Samples** 3
Non-Fibrous Components (in approx. decreasing order): powder, rock,

Layers					Percents of Each Fiber					
#	Layer Type	%	Color	Friability	Fib 1	Fib 2	Fib 3	Fib 4	Fib 5	Fib 6
1	block	100	Red	1	n.d.	-	-	-	-	-
Total %		100	Average %		n.d.	-	-	-	-	-
Fiber Identification:					none					

Fibers									Refractive Index Determinations				
#	Color	Mrph	Iso	Pleo	Bi	Elg	Ext	Oil	Col Par	Col Per	RI Par	RI Per	
1	none												
2													
3													
4													
5													
6													

Sample Analytical Note
 Procedure: tweased apart using forceps. Procedure: dissolution of matrix using dilute HCl acid.

Sample M-CMU-02C **Lab Number** 2008-02110- 6 **Sampled:** 3/6/2008 **Condition:** acceptable
Analyzed By LSP 4/3/2008 **An?** OK **Apparent Smp Type** Cementitious Non-fibrous Solid
Homogeneous Yes **# Layers** 1 **Pos Layer?** No **# Sub-Samples** 3
Non-Fibrous Components (in approx. decreasing order): powder, rock,

Layers					Percents of Each Fiber					
#	Layer Type	%	Color	Friability	Fib 1	Fib 2	Fib 3	Fib 4	Fib 5	Fib 6
1	block	100	Red	1	n.d.	-	-	-	-	-
Total %		100	Average %		n.d.	-	-	-	-	-
Fiber Identification:					none					

Fibers									Refractive Index Determinations				
#	Color	Mrph	Iso	Pleo	Bi	Elg	Ext	Oil	Col Par	Col Per	RI Par	RI Per	
1	none												
2													
3													
4													
5													
6													

Sample Analytical Note
 Procedure: tweased apart using forceps. Procedure: dissolution of matrix using dilute HCl acid.

PLM Analysis Details

Job Number: 200802110

08-085/Kyrene De La Esperanza

Sample M-CMU-03A **Lab Number** 2008-02110- 7 **Sampled:** 3/6/2008 **Condition:** acceptable
Analyzed By LSP 4/3/2008 **An?** OK **Apparent Smp Type** Cementitious Non-fibrous Solid
Homogeneous Yes **# Layers** 1 **Pos Layer?** No **# Sub-Samples** 3
Non-Fibrous Components (in approx. decreasing order): powder, rock,

Layers					Percents of Each Fiber					
#	Layer Type	%	Color	Friability	Fib 1	Fib 2	Fib 3	Fib 4	Fib 5	Fib 6
1	block	100	Gray	1	n.d.	-	-	-	-	-
Total %		100	Average %		n.d.	-	-	-	-	-
Fiber Identification: none										

Fibers									Refractive Index Determinations				
#	Color	Mrph	Iso	Pleo	Bi	Elg	Ext	Oil	Col Par	Col Per	RI Par	RI Per	
1	none												
2													
3													
4													
5													
6													

Sample Analytical Note
 Procedure: tweased apart using forceps. Procedure: dissolution of matrix using dilute HCl acid.

Sample M-CMU-03B **Lab Number** 2008-02110- 8 **Sampled:** 3/6/2008 **Condition:** acceptable
Analyzed By LSP 4/3/2008 **An?** OK **Apparent Smp Type** Cementitious Non-fibrous Solid
Homogeneous Yes **# Layers** 1 **Pos Layer?** No **# Sub-Samples** 3
Non-Fibrous Components (in approx. decreasing order): powder, rock,

Layers					Percents of Each Fiber					
#	Layer Type	%	Color	Friability	Fib 1	Fib 2	Fib 3	Fib 4	Fib 5	Fib 6
1	block	100	Gray	1	n.d.	-	-	-	-	-
Total %		100	Average %		n.d.	-	-	-	-	-
Fiber Identification: none										

Fibers									Refractive Index Determinations				
#	Color	Mrph	Iso	Pleo	Bi	Elg	Ext	Oil	Col Par	Col Per	RI Par	RI Per	
1	none												
2													
3													
4													
5													
6													

Sample Analytical Note
 Procedure: tweased apart using forceps. Procedure: dissolution of matrix using dilute HCl acid.

Sample M-CMU-03C **Lab Number** 2008-02110- 9 **Sampled:** 3/6/2008 **Condition:** acceptable
Analyzed By LSP 4/3/2008 **An?** OK **Apparent Smp Type** Cementitious Non-fibrous Solid
Homogeneous Yes **# Layers** 1 **Pos Layer?** No **# Sub-Samples** 3
Non-Fibrous Components (in approx. decreasing order): powder, rock,

Layers					Percents of Each Fiber					
#	Layer Type	%	Color	Friability	Fib 1	Fib 2	Fib 3	Fib 4	Fib 5	Fib 6
1	block	100	Gray	1	n.d.	-	-	-	-	-
Total %		100	Average %		n.d.	-	-	-	-	-
Fiber Identification: none										

Fibers									Refractive Index Determinations				
#	Color	Mrph	Iso	Pleo	Bi	Elg	Ext	Oil	Col Par	Col Per	RI Par	RI Per	
1	none												
2													
3													
4													
5													
6													

Sample Analytical Note
 Procedure: tweased apart using forceps. Procedure: dissolution of matrix using dilute HCl acid.

PLM Analysis Details

Job Number: 200802110 08-085/Kyrene De La Esperanza

Sample M-CMU-04A **Lab Number** 2008-02110- 10 **Sampled:** 3/6/2008 **Condition:** acceptable
Analyzed By LSP 4/3/2008 **An?** OK **Apparent Smp Type** Cementitious Non-fibrous Solid
Homogeneous Yes **# Layers** 1 **Pos Layer?** No **# Sub-Samples** 3
Non-Fibrous Components (in approx. decreasing order): powder, rock,

Layers					Percents of Each Fiber					
#	Layer Type	%	Color	Friability	Fib 1	Fib 2	Fib 3	Fib 4	Fib 5	Fib 6
1	block	100	Gray	1	n.d.	-	-	-	-	-
Total %		100	Average %		n.d.	-	-	-	-	-
Fiber Identification: none										

Fibers									Refractive Index Determinations				
#	Color	Mrph	Iso	Pleo	Bi	Elg	Ext	Oil	Col Par	Col Per	RI Par	RI Per	
1	none												
2													
3													
4													
5													
6													

Sample Analytical Note
 Procedure: teased apart using forceps. Procedure: dissolution of matrix using dilute HCl acid.

Sample M-CMU-04B **Lab Number** 2008-02110- 11 **Sampled:** 3/6/2008 **Condition:** acceptable
Analyzed By LSP 4/3/2008 **An?** OK **Apparent Smp Type** Cementitious Non-fibrous Solid
Homogeneous Yes **# Layers** 1 **Pos Layer?** No **# Sub-Samples** 3
Non-Fibrous Components (in approx. decreasing order): powder, rock,

Layers					Percents of Each Fiber					
#	Layer Type	%	Color	Friability	Fib 1	Fib 2	Fib 3	Fib 4	Fib 5	Fib 6
1	block	100	Gray	1	n.d.	-	-	-	-	-
Total %		100	Average %		n.d.	-	-	-	-	-
Fiber Identification: none										

Fibers									Refractive Index Determinations				
#	Color	Mrph	Iso	Pleo	Bi	Elg	Ext	Oil	Col Par	Col Per	RI Par	RI Per	
1	none												
2													
3													
4													
5													
6													

Sample Analytical Note
 Procedure: teased apart using forceps. Procedure: dissolution of matrix using dilute HCl acid.

Sample M-CMU-04C **Lab Number** 2008-02110- 12 **Sampled:** 3/6/2008 **Condition:** acceptable
Analyzed By LSP 4/3/2008 **An?** OK **Apparent Smp Type** Cementitious Non-fibrous Solid
Homogeneous Yes **# Layers** 1 **Pos Layer?** No **# Sub-Samples** 3
Non-Fibrous Components (in approx. decreasing order): powder, rock,

Layers					Percents of Each Fiber					
#	Layer Type	%	Color	Friability	Fib 1	Fib 2	Fib 3	Fib 4	Fib 5	Fib 6
1	block	100	Gray	1	n.d.	-	-	-	-	-
Total %		100	Average %		n.d.	-	-	-	-	-
Fiber Identification: none										

Fibers									Refractive Index Determinations				
#	Color	Mrph	Iso	Pleo	Bi	Elg	Ext	Oil	Col Par	Col Per	RI Par	RI Per	
1	none												
2													
3													
4													
5													
6													

Sample Analytical Note
 Procedure: teased apart using forceps. Procedure: dissolution of matrix using dilute HCl acid.

PLM Analysis Details

Job Number: 200802110 08-085/Kyrene De La Esperanza

Sample M-MRT-05A **Lab Number** 2008-02110- 13 **Sampled:** 3/6/2008 **Condition:** acceptable
Analyzed By LSP 4/3/2008 **An?** OK **Apparent Smp Type** Cementitious Non-fibrous Solid
Homogeneous Yes **# Layers** 1 **Pos Layer?** No **# Sub-Samples** 3
Non-Fibrous Components (in approx. decreasing order): powder, rock,

Layers					Percents of Each Fiber					
#	Layer Type	%	Color	Friability	Fib 1	Fib 2	Fib 3	Fib 4	Fib 5	Fib 6
1	mortar	100	Gray	2	n.d.	-	-	-	-	-
Total %		100	Average %			n.d.	-	-	-	-
Fiber Identification: none										

Fibers									Refractive Index Determinations				
#	Color	Mrph	Iso	Pleo	Bi	Elg	Ext	Oil	Col Par	Col Per	RI Par	RI Per	
1	none												
2													
3													
4													
5													
6													

Sample Analytical Note
 Procedure: tweased apart using forceps. Procedure: dissolution of matrix using dilute HCl acid.

Sample M-MRT-05B **Lab Number** 2008-02110- 14 **Sampled:** 3/6/2008 **Condition:** acceptable
Analyzed By LSP 4/3/2008 **An?** OK **Apparent Smp Type** Cementitious Non-fibrous Solid
Homogeneous Yes **# Layers** 1 **Pos Layer?** No **# Sub-Samples** 3
Non-Fibrous Components (in approx. decreasing order): powder, rock,

Layers					Percents of Each Fiber					
#	Layer Type	%	Color	Friability	Fib 1	Fib 2	Fib 3	Fib 4	Fib 5	Fib 6
1	mortar	100	Gray	2	n.d.	-	-	-	-	-
Total %		100	Average %			n.d.	-	-	-	-
Fiber Identification: none										

Fibers									Refractive Index Determinations				
#	Color	Mrph	Iso	Pleo	Bi	Elg	Ext	Oil	Col Par	Col Per	RI Par	RI Per	
1	none												
2													
3													
4													
5													
6													

Sample Analytical Note
 Procedure: tweased apart using forceps. Procedure: dissolution of matrix using dilute HCl acid.

Sample M-MRT-05C **Lab Number** 2008-02110- 15 **Sampled:** 3/6/2008 **Condition:** acceptable
Analyzed By LSP 4/3/2008 **An?** OK **Apparent Smp Type** Cementitious Non-fibrous Solid
Homogeneous Yes **# Layers** 1 **Pos Layer?** No **# Sub-Samples** 3
Non-Fibrous Components (in approx. decreasing order): powder, rock,

Layers					Percents of Each Fiber					
#	Layer Type	%	Color	Friability	Fib 1	Fib 2	Fib 3	Fib 4	Fib 5	Fib 6
1	mortar	100	Gray	2	n.d.	-	-	-	-	-
Total %		100	Average %			n.d.	-	-	-	-
Fiber Identification: none										

Fibers									Refractive Index Determinations				
#	Color	Mrph	Iso	Pleo	Bi	Elg	Ext	Oil	Col Par	Col Per	RI Par	RI Per	
1	none												
2													
3													
4													
5													
6													

Sample Analytical Note
 Procedure: tweased apart using forceps. Procedure: dissolution of matrix using dilute HCl acid.

PLM Analysis Details

Job Number: 200802110 08-085/Kyrene De La Esperanza

Sample M-SLT-06A **Lab Number** 2008-02110- 16 **Sampled:** 3/6/2008 **Condition:** acceptable
Analyzed By LSP 4/3/2008 **An?** OK **Apparent Smp Type** Adhesive/caulk **Non-fibrous Solid**
Homogeneous Yes **# Layers** 1 **Pos Layer?** No **# Sub-Samples** 3
Non-Fibrous Components (in approx. decreasing order): filler, binder,

Layers					Percents of Each Fiber					
#	Layer Type	%	Color	Friability	Fib 1	Fib 2	Fib 3	Fib 4	Fib 5	Fib 6
1	sealant	100	Gray	1	n.d.	-	-	-	-	-
Total %		100	Average %		n.d.	-	-	-	-	-
Fiber Identification: none										

Fibers									Refractive Index Determinations				
#	Color	Mrph	Iso	Pleo	Bi	Elg	Ext	Oil	Col Par	Col Per	RI Par	RI Per	
1	none												
2													
3													
4													
5													
6													

Sample Analytical Note
 Procedure: tweased apart using forceps. Procedure: dissolution of matrix using solvent.

Sample M-SLT-06B **Lab Number** 2008-02110- 17 **Sampled:** 3/6/2008 **Condition:** acceptable
Analyzed By LSP 4/3/2008 **An?** OK **Apparent Smp Type** Adhesive/caulk **Non-fibrous Solid**
Homogeneous Yes **# Layers** 1 **Pos Layer?** No **# Sub-Samples** 3
Non-Fibrous Components (in approx. decreasing order): filler, binder,

Layers					Percents of Each Fiber					
#	Layer Type	%	Color	Friability	Fib 1	Fib 2	Fib 3	Fib 4	Fib 5	Fib 6
1	sealant	100	Gray	1	n.d.	-	-	-	-	-
Total %		100	Average %		n.d.	-	-	-	-	-
Fiber Identification: none										

Fibers									Refractive Index Determinations				
#	Color	Mrph	Iso	Pleo	Bi	Elg	Ext	Oil	Col Par	Col Per	RI Par	RI Per	
1	none												
2													
3													
4													
5													
6													

Sample Analytical Note
 Procedure: tweased apart using forceps. Procedure: dissolution of matrix using solvent.

Sample M-SLT-06C **Lab Number** 2008-02110- 18 **Sampled:** 3/6/2008 **Condition:** acceptable
Analyzed By LSP 4/3/2008 **An?** OK **Apparent Smp Type** Adhesive/caulk **Non-fibrous Solid**
Homogeneous Yes **# Layers** 1 **Pos Layer?** No **# Sub-Samples** 3
Non-Fibrous Components (in approx. decreasing order): filler, binder,

Layers					Percents of Each Fiber					
#	Layer Type	%	Color	Friability	Fib 1	Fib 2	Fib 3	Fib 4	Fib 5	Fib 6
1	sealant	100	Gray	1	n.d.	-	-	-	-	-
Total %		100	Average %		n.d.	-	-	-	-	-
Fiber Identification: none										

Fibers									Refractive Index Determinations				
#	Color	Mrph	Iso	Pleo	Bi	Elg	Ext	Oil	Col Par	Col Per	RI Par	RI Per	
1	none												
2													
3													
4													
5													
6													

Sample Analytical Note
 Procedure: tweased apart using forceps. Procedure: dissolution of matrix using solvent.

PLM Analysis Details

Job Number: 200802110 08-085/Kyrene De La Esperanza

Sample M-MRT-08A **Lab Number** 2008-02110- 19 **Sampled:** 3/6/2008 **Condition:** acceptable
Analyzed By LSP 4/3/2008 **An?** OK **Apparent Smp Type** Cementitious Non-fibrous Solid
Homogeneous Yes **# Layers** 1 **Pos Layer?** No **# Sub-Samples** 3
Non-Fibrous Components (in approx. decreasing order): powder, rock,

Layers					Percents of Each Fiber					
#	Layer Type	%	Color	Friability	Fib 1	Fib 2	Fib 3	Fib 4	Fib 5	Fib 6
1	mortar	100	White	2	n.d.	-	-	-	-	-
Total %		100	Average %		n.d.	-	-	-	-	-
Fiber Identification: none										

Fibers									Refractive Index Determinations				
#	Color	Mrph	Iso	Pleo	Bi	Elg	Ext	Oil	Col Par	Col Per	RI Par	RI Per	
1	none												
2													
3													
4													
5													
6													

Sample Analytical Note
 Procedure: teased apart using forceps. Procedure: dissolution of matrix using dilute HCl acid.

Sample M-MRT-08B **Lab Number** 2008-02110- 20 **Sampled:** 3/6/2008 **Condition:** acceptable
Analyzed By LSP 4/3/2008 **An?** OK **Apparent Smp Type** Cementitious Non-fibrous Solid
Homogeneous Yes **# Layers** 1 **Pos Layer?** No **# Sub-Samples** 3
Non-Fibrous Components (in approx. decreasing order): powder, rock,

Layers					Percents of Each Fiber					
#	Layer Type	%	Color	Friability	Fib 1	Fib 2	Fib 3	Fib 4	Fib 5	Fib 6
1	mortar	100	White	2	n.d.	-	-	-	-	-
Total %		100	Average %		n.d.	-	-	-	-	-
Fiber Identification: none										

Fibers									Refractive Index Determinations				
#	Color	Mrph	Iso	Pleo	Bi	Elg	Ext	Oil	Col Par	Col Per	RI Par	RI Per	
1	none												
2													
3													
4													
5													
6													

Sample Analytical Note
 Procedure: teased apart using forceps. Procedure: dissolution of matrix using dilute HCl acid.

Sample M-MRT-08C **Lab Number** 2008-02110- 21 **Sampled:** 3/6/2008 **Condition:** acceptable
Analyzed By LSP 4/3/2008 **An?** OK **Apparent Smp Type** Cementitious Non-fibrous Solid
Homogeneous Yes **# Layers** 1 **Pos Layer?** No **# Sub-Samples** 3
Non-Fibrous Components (in approx. decreasing order): powder, rock,

Layers					Percents of Each Fiber					
#	Layer Type	%	Color	Friability	Fib 1	Fib 2	Fib 3	Fib 4	Fib 5	Fib 6
1	mortar	100	White	2	n.d.	-	-	-	-	-
Total %		100	Average %		n.d.	-	-	-	-	-
Fiber Identification: none										

Fibers									Refractive Index Determinations				
#	Color	Mrph	Iso	Pleo	Bi	Elg	Ext	Oil	Col Par	Col Per	RI Par	RI Per	
1	none												
2													
3													
4													
5													
6													

Sample Analytical Note
 Procedure: teased apart using forceps. Procedure: dissolution of matrix using dilute HCl acid.

PLM Analysis Details

Job Number: 200802110 08-085/Kyrene De La Esperanza

Sample M-SLT-09A **Lab Number** 2008-02110- 22 **Sampled:** 3/6/2008 **Condition:** acceptable
Analyzed By LSP 4/3/2008 **An?** OK **Apparent Smp Type** Adhesive/caulk **Non-fibrous Solid**
Homogeneous Yes **# Layers** 1 **Pos Layer?** No **# Sub-Samples** 3
Non-Fibrous Components (in approx. decreasing order): filler, binder,

Layers					Percents of Each Fiber					
#	Layer Type	%	Color	Friability	Fib 1	Fib 2	Fib 3	Fib 4	Fib 5	Fib 6
1	sealant	100	White	1	n.d.	-	-	-	-	-
Total %		100	Average %		n.d.	-	-	-	-	-
Fiber Identification: none										

Fibers									Refractive Index Determinations				
#	Color	Mrph	Iso	Pleo	Bi	Elg	Ext	Oil	Col Par	Col Per	RI Par	RI Per	
1	none												
2													
3													
4													
5													
6													

Sample Analytical Note
 Procedure: tweased apart using forceps. Procedure: dissolution of matrix using solvent.

Sample M-SLT-09B **Lab Number** 2008-02110- 23 **Sampled:** 3/6/2008 **Condition:** acceptable
Analyzed By LSP 4/3/2008 **An?** OK **Apparent Smp Type** Adhesive/caulk **Non-fibrous Solid**
Homogeneous Yes **# Layers** 1 **Pos Layer?** No **# Sub-Samples** 3
Non-Fibrous Components (in approx. decreasing order): filler, binder,

Layers					Percents of Each Fiber					
#	Layer Type	%	Color	Friability	Fib 1	Fib 2	Fib 3	Fib 4	Fib 5	Fib 6
1	sealant	100	White	1	n.d.	-	-	-	-	-
Total %		100	Average %		n.d.	-	-	-	-	-
Fiber Identification: none										

Fibers									Refractive Index Determinations				
#	Color	Mrph	Iso	Pleo	Bi	Elg	Ext	Oil	Col Par	Col Per	RI Par	RI Per	
1	none												
2													
3													
4													
5													
6													

Sample Analytical Note
 Procedure: tweased apart using forceps. Procedure: dissolution of matrix using solvent.

Sample M-SLT-09C **Lab Number** 2008-02110- 24 **Sampled:** 3/6/2008 **Condition:** acceptable
Analyzed By LSP 4/3/2008 **An?** OK **Apparent Smp Type** Adhesive/caulk **Non-fibrous Solid**
Homogeneous Yes **# Layers** 1 **Pos Layer?** No **# Sub-Samples** 3
Non-Fibrous Components (in approx. decreasing order): filler, binder,

Layers					Percents of Each Fiber					
#	Layer Type	%	Color	Friability	Fib 1	Fib 2	Fib 3	Fib 4	Fib 5	Fib 6
1	sealant	100	White	1	n.d.	-	-	-	-	-
Total %		100	Average %		n.d.	-	-	-	-	-
Fiber Identification: none										

Fibers									Refractive Index Determinations				
#	Color	Mrph	Iso	Pleo	Bi	Elg	Ext	Oil	Col Par	Col Per	RI Par	RI Per	
1	none												
2													
3													
4													
5													
6													

Sample Analytical Note
 Procedure: tweased apart using forceps. Procedure: dissolution of matrix using solvent.

PLM Analysis Details

Job Number: 200802110 08-085/Kyrene De La Esperanza

Sample M-CON-12A **Lab Number** 2008-02110- 25 **Sampled:** 3/6/2008 **Condition:** acceptable
Analyzed By LSP 4/3/2008 **An?** OK **Apparent Smp Type** Cementitious Non-fibrous Solid
Homogeneous Yes **# Layers** 1 **Pos Layer?** No **# Sub-Samples** 3
Non-Fibrous Components (in approx. decreasing order): powder, rock,

Layers					Percents of Each Fiber					
#	Layer Type	%	Color	Friability	Fib 1	Fib 2	Fib 3	Fib 4	Fib 5	Fib 6
1	concrete	100	gray	1	n.d.	-	-	-	-	-
Total %		100	Average %		n.d.	-	-	-	-	-
Fiber Identification: none										

Fibers									Refractive Index Determinations				
#	Color	Mrph	Iso	Pleo	Bi	Elg	Ext	Oil	Col Par	Col Per	RI Par	RI Per	
1	none												
2													
3													
4													
5													
6													

Sample Analytical Note
 Procedure: tweased apart using forceps. Procedure: dissolution of matrix using dilute HCl acid.

Sample M-CON-12B **Lab Number** 2008-02110- 26 **Sampled:** 3/6/2008 **Condition:** acceptable
Analyzed By LSP 4/3/2008 **An?** OK **Apparent Smp Type** Cementitious Non-fibrous Solid
Homogeneous Yes **# Layers** 1 **Pos Layer?** No **# Sub-Samples** 3
Non-Fibrous Components (in approx. decreasing order): powder, rock,

Layers					Percents of Each Fiber					
#	Layer Type	%	Color	Friability	Fib 1	Fib 2	Fib 3	Fib 4	Fib 5	Fib 6
1	concrete	100	gray	1	n.d.	-	-	-	-	-
Total %		100	Average %		n.d.	-	-	-	-	-
Fiber Identification: none										

Fibers									Refractive Index Determinations				
#	Color	Mrph	Iso	Pleo	Bi	Elg	Ext	Oil	Col Par	Col Per	RI Par	RI Per	
1	none												
2													
3													
4													
5													
6													

Sample Analytical Note
 Procedure: tweased apart using forceps. Procedure: dissolution of matrix using dilute HCl acid.

Sample M-CON-12C **Lab Number** 2008-02110- 27 **Sampled:** 3/6/2008 **Condition:** acceptable
Analyzed By LSP 4/3/2008 **An?** OK **Apparent Smp Type** Cementitious Non-fibrous Solid
Homogeneous Yes **# Layers** 1 **Pos Layer?** No **# Sub-Samples** 3
Non-Fibrous Components (in approx. decreasing order): powder, rock,

Layers					Percents of Each Fiber					
#	Layer Type	%	Color	Friability	Fib 1	Fib 2	Fib 3	Fib 4	Fib 5	Fib 6
1	concrete	100	gray	1	n.d.	-	-	-	-	-
Total %		100	Average %		n.d.	-	-	-	-	-
Fiber Identification: none										

Fibers									Refractive Index Determinations				
#	Color	Mrph	Iso	Pleo	Bi	Elg	Ext	Oil	Col Par	Col Per	RI Par	RI Per	
1	none												
2													
3													
4													
5													
6													

Sample Analytical Note
 Procedure: tweased apart using forceps. Procedure: dissolution of matrix using dilute HCl acid.

PLM Analysis Details

Job Number: 200802110 08-085/Kyrene De La Esperanza

Sample M-CON-13A **Lab Number** 2008-02110- 28 **Sampled:** 3/6/2008 **Condition:** acceptable
Analyzed By LSP 4/3/2008 **An?** OK **Apparent Smp Type** Cementitious **Non-fibrous Solid**
Homogeneous Yes **# Layers** 1 **Pos Layer?** No **# Sub-Samples** 3
Non-Fibrous Components (in approx. decreasing order): powder, rock,

Layers					Percents of Each Fiber					
#	Layer Type	%	Color	Friability	Fib 1	Fib 2	Fib 3	Fib 4	Fib 5	Fib 6
1	concrete	100	gray	1	n.d.	-	-	-	-	-
Total %		100	Average %		n.d.	-	-	-	-	-
Fiber Identification:					none					

Fibers									Refractive Index Determinations				
#	Color	Mrph	Iso	Pleo	Bi	Elg	Ext	Oil	Col Par	Col Per	RI Par	RI Per	
1	none												
2													
3													
4													
5													
6													

Sample Analytical Note
 Procedure: tweased apart using forceps. Procedure: dissolution of matrix using dilute HCl acid.

Sample M-CON-13B **Lab Number** 2008-02110- 29 **Sampled:** 3/6/2008 **Condition:** acceptable
Analyzed By LSP 4/3/2008 **An?** OK **Apparent Smp Type** Cementitious **Non-fibrous Solid**
Homogeneous Yes **# Layers** 1 **Pos Layer?** No **# Sub-Samples** 3
Non-Fibrous Components (in approx. decreasing order): powder, rock,

Layers					Percents of Each Fiber					
#	Layer Type	%	Color	Friability	Fib 1	Fib 2	Fib 3	Fib 4	Fib 5	Fib 6
1	concrete	100	gray	1	n.d.	-	-	-	-	-
Total %		100	Average %		n.d.	-	-	-	-	-
Fiber Identification:					none					

Fibers									Refractive Index Determinations				
#	Color	Mrph	Iso	Pleo	Bi	Elg	Ext	Oil	Col Par	Col Per	RI Par	RI Per	
1	none												
2													
3													
4													
5													
6													

Sample Analytical Note
 Procedure: tweased apart using forceps. Procedure: dissolution of matrix using dilute HCl acid.

Sample M-CON-13C **Lab Number** 2008-02110- 30 **Sampled:** 3/6/2008 **Condition:** acceptable
Analyzed By LSP 4/3/2008 **An?** OK **Apparent Smp Type** Cementitious **Non-fibrous Solid**
Homogeneous Yes **# Layers** 1 **Pos Layer?** No **# Sub-Samples** 3
Non-Fibrous Components (in approx. decreasing order): powder, rock,

Layers					Percents of Each Fiber					
#	Layer Type	%	Color	Friability	Fib 1	Fib 2	Fib 3	Fib 4	Fib 5	Fib 6
1	concrete	100	gray	1	n.d.	-	-	-	-	-
Total %		100	Average %		n.d.	-	-	-	-	-
Fiber Identification:					none					

Fibers									Refractive Index Determinations				
#	Color	Mrph	Iso	Pleo	Bi	Elg	Ext	Oil	Col Par	Col Per	RI Par	RI Per	
1	none												
2													
3													
4													
5													
6													

Sample Analytical Note
 Procedure: tweased apart using forceps. Procedure: dissolution of matrix using dilute HCl acid.

PLM Analysis Details

Job Number: 200802110 08-085/Kyrene De La Esperanza

Sample M-CMU-15A **Lab Number** 2008-02110- 31 **Sampled:** 3/6/2008 **Condition:** acceptable
Analyzed By LSP 4/3/2008 **An?** OK **Apparent Smp Type** Cementitious Non-fibrous Solid
Homogeneous Yes **# Layers** 1 **Pos Layer?** No **# Sub-Samples** 3
Non-Fibrous Components (in approx. decreasing order): powder, rock,

Layers					Percents of Each Fiber					
#	Layer Type	%	Color	Friability	Fib 1	Fib 2	Fib 3	Fib 4	Fib 5	Fib 6
1	block	100	Gray	1	n.d.	-	-	-	-	-
Total %		100	Average %		n.d.	-	-	-	-	-
Fiber Identification: none										

Fibers									Refractive Index Determinations				
#	Color	Mrph	Iso	Pleo	Bi	Elg	Ext	Oil	Col Par	Col Per	RI Par	RI Per	
1	none												
2													
3													
4													
5													
6													

Sample Analytical Note
 Procedure: tweased apart using forceps. Procedure: dissolution of matrix using dilute HCl acid.

Sample M-CMU-15B **Lab Number** 2008-02110- 32 **Sampled:** 3/6/2008 **Condition:** acceptable
Analyzed By LSP 4/3/2008 **An?** OK **Apparent Smp Type** Cementitious Non-fibrous Solid
Homogeneous Yes **# Layers** 1 **Pos Layer?** No **# Sub-Samples** 3
Non-Fibrous Components (in approx. decreasing order): powder, rock,

Layers					Percents of Each Fiber					
#	Layer Type	%	Color	Friability	Fib 1	Fib 2	Fib 3	Fib 4	Fib 5	Fib 6
1	block	100	Gray	1	n.d.	-	-	-	-	-
Total %		100	Average %		n.d.	-	-	-	-	-
Fiber Identification: none										

Fibers									Refractive Index Determinations				
#	Color	Mrph	Iso	Pleo	Bi	Elg	Ext	Oil	Col Par	Col Per	RI Par	RI Per	
1	none												
2													
3													
4													
5													
6													

Sample Analytical Note
 Procedure: tweased apart using forceps. Procedure: dissolution of matrix using dilute HCl acid.

Sample M-CMU-15C **Lab Number** 2008-02110- 33 **Sampled:** 3/6/2008 **Condition:** acceptable
Analyzed By LSP 4/3/2008 **An?** OK **Apparent Smp Type** Cementitious Non-fibrous Solid
Homogeneous Yes **# Layers** 1 **Pos Layer?** No **# Sub-Samples** 3
Non-Fibrous Components (in approx. decreasing order): powder, rock,

Layers					Percents of Each Fiber					
#	Layer Type	%	Color	Friability	Fib 1	Fib 2	Fib 3	Fib 4	Fib 5	Fib 6
1	block	100	Gray	1	n.d.	-	-	-	-	-
Total %		100	Average %		n.d.	-	-	-	-	-
Fiber Identification: none										

Fibers									Refractive Index Determinations				
#	Color	Mrph	Iso	Pleo	Bi	Elg	Ext	Oil	Col Par	Col Per	RI Par	RI Per	
1	none												
2													
3													
4													
5													
6													

Sample Analytical Note
 Procedure: tweased apart using forceps. Procedure: dissolution of matrix using dilute HCl acid.

PLM Analysis Details

Job Number: 200802110 08-085/Kyrene De La Esperanza

Sample M-CMU-16A **Lab Number** 2008-02110- 34 **Sampled:** 3/6/2008 **Condition:** acceptable
Analyzed By LSP 4/3/2008 **An?** OK **Apparent Smp Type** Cementitious **Non-fibrous Solid**
Homogeneous Yes **# Layers** 1 **Pos Layer?** No **# Sub-Samples** 3
Non-Fibrous Components (in approx. decreasing order): powder, rock,

Layers					Percents of Each Fiber					
#	Layer Type	%	Color	Friability	Fib 1	Fib 2	Fib 3	Fib 4	Fib 5	Fib 6
1	block	100	Gray	1	n.d.	-	-	-	-	-
Total %		100	Average %		n.d.	-	-	-	-	-
Fiber Identification:					none					

Fibers									Refractive Index Determinations				
#	Color	Mrph	Iso	Pleo	Bi	Elg	Ext	Oil	Col Par	Col Per	RI Par	RI Per	
1	none												
2													
3													
4													
5													
6													

Sample Analytical Note
 Procedure: tweased apart using forceps. Procedure: dissolution of matrix using dilute HCl acid.

Sample M-CMU-16B **Lab Number** 2008-02110- 35 **Sampled:** 3/6/2008 **Condition:** acceptable
Analyzed By LSP 4/3/2008 **An?** OK **Apparent Smp Type** Cementitious **Non-fibrous Solid**
Homogeneous Yes **# Layers** 1 **Pos Layer?** No **# Sub-Samples** 3
Non-Fibrous Components (in approx. decreasing order): powder, rock,

Layers					Percents of Each Fiber					
#	Layer Type	%	Color	Friability	Fib 1	Fib 2	Fib 3	Fib 4	Fib 5	Fib 6
1	block	100	Gray	1	n.d.	-	-	-	-	-
Total %		100	Average %		n.d.	-	-	-	-	-
Fiber Identification:					none					

Fibers									Refractive Index Determinations				
#	Color	Mrph	Iso	Pleo	Bi	Elg	Ext	Oil	Col Par	Col Per	RI Par	RI Per	
1	none												
2													
3													
4													
5													
6													

Sample Analytical Note
 Procedure: tweased apart using forceps. Procedure: dissolution of matrix using dilute HCl acid.

Sample M-CMU-16C **Lab Number** 2008-02110- 36 **Sampled:** 3/6/2008 **Condition:** acceptable
Analyzed By LSP 4/3/2008 **An?** OK **Apparent Smp Type** Cementitious **Non-fibrous Solid**
Homogeneous Yes **# Layers** 1 **Pos Layer?** No **# Sub-Samples** 3
Non-Fibrous Components (in approx. decreasing order): powder, rock,

Layers					Percents of Each Fiber					
#	Layer Type	%	Color	Friability	Fib 1	Fib 2	Fib 3	Fib 4	Fib 5	Fib 6
1	block	100	Gray	1	n.d.	-	-	-	-	-
Total %		100	Average %		n.d.	-	-	-	-	-
Fiber Identification:					none					

Fibers									Refractive Index Determinations				
#	Color	Mrph	Iso	Pleo	Bi	Elg	Ext	Oil	Col Par	Col Per	RI Par	RI Per	
1	none												
2													
3													
4													
5													
6													

Sample Analytical Note
 Procedure: tweased apart using forceps. Procedure: dissolution of matrix using dilute HCl acid.

PLM Analysis Details

Job Number: 200802110 08-085/Kyrene De La Esperanza

Sample M-MRT-17A **Lab Number** 2008-02110- 37 **Sampled:** 3/6/2008 **Condition:** acceptable
Analyzed By LSP 4/3/2008 **An?** OK **Apparent Smp Type** Cementitious Non-fibrous Solid
Homogeneous Yes **# Layers** 1 **Pos Layer?** No **# Sub-Samples** 3
Non-Fibrous Components (in approx. decreasing order): powder, rock,

Layers					Percents of Each Fiber					
#	Layer Type	%	Color	Friability	Fib 1	Fib 2	Fib 3	Fib 4	Fib 5	Fib 6
1	mortar	100	Gray	2	n.d.	-	-	-	-	-
Total %		100	Average %		n.d.	-	-	-	-	-
Fiber Identification:					none					

Fibers									Refractive Index Determinations				
#	Color	Mrph	Iso	Pleo	Bi	Elg	Ext	Oil	Col Par	Col Per	RI Par	RI Per	
1	none												
2													
3													
4													
5													
6													

Sample Analytical Note
 Procedure: teased apart using forceps. Procedure: dissolution of matrix using dilute HCl acid.

Sample M-MRT-17B **Lab Number** 2008-02110- 38 **Sampled:** 3/6/2008 **Condition:** acceptable
Analyzed By LSP 4/3/2008 **An?** OK **Apparent Smp Type** Cementitious Non-fibrous Solid
Homogeneous Yes **# Layers** 1 **Pos Layer?** No **# Sub-Samples** 3
Non-Fibrous Components (in approx. decreasing order): powder, rock,

Layers					Percents of Each Fiber					
#	Layer Type	%	Color	Friability	Fib 1	Fib 2	Fib 3	Fib 4	Fib 5	Fib 6
1	mortar	100	Gray	2	n.d.	-	-	-	-	-
Total %		100	Average %		n.d.	-	-	-	-	-
Fiber Identification:					none					

Fibers									Refractive Index Determinations				
#	Color	Mrph	Iso	Pleo	Bi	Elg	Ext	Oil	Col Par	Col Per	RI Par	RI Per	
1	none												
2													
3													
4													
5													
6													

Sample Analytical Note
 Procedure: teased apart using forceps. Procedure: dissolution of matrix using dilute HCl acid.

Sample M-MRT-17C **Lab Number** 2008-02110- 39 **Sampled:** 3/6/2008 **Condition:** acceptable
Analyzed By LSP 4/3/2008 **An?** OK **Apparent Smp Type** Cementitious Non-fibrous Solid
Homogeneous Yes **# Layers** 1 **Pos Layer?** No **# Sub-Samples** 3
Non-Fibrous Components (in approx. decreasing order): powder, rock,

Layers					Percents of Each Fiber					
#	Layer Type	%	Color	Friability	Fib 1	Fib 2	Fib 3	Fib 4	Fib 5	Fib 6
1	mortar	100	Gray	2	n.d.	-	-	-	-	-
Total %		100	Average %		n.d.	-	-	-	-	-
Fiber Identification:					none					

Fibers									Refractive Index Determinations				
#	Color	Mrph	Iso	Pleo	Bi	Elg	Ext	Oil	Col Par	Col Per	RI Par	RI Per	
1	none												
2													
3													
4													
5													
6													

Sample Analytical Note
 Procedure: teased apart using forceps. Procedure: dissolution of matrix using dilute HCl acid.

PLM Analysis Details

Job Number: 200802110 08-085/Kyrene De La Esperanza

Sample S-TOT-20A **Lab Number** 2008-02110- 40 **Sampled:** 3/6/2008 **Condition:** acceptable
Analyzed By LSP 4/3/2008 **An?** OK **Apparent Smp Type** Wall System **Non-fibrous Solid**
Homogeneous Yes **# Layers** 1 **Pos Layer?** No **# Sub-Samples** 3
Non-Fibrous Components (in approx. decreasing order): powder, ,

Layers					Percents of Each Fiber					
#	Layer Type	%	Color	Friability	Fib 1	Fib 2	Fib 3	Fib 4	Fib 5	Fib 6
1	texture/joint compound	100	white	3	n.d.	-	-	-	-	-
Total %		100	Average %		n.d.	-	-	-	-	-
Fiber Identification: none										

Fibers									Refractive Index Determinations				
#	Color	Mrph	Iso	Pleo	Bi	Elg	Ext	Oil	Col Par	Col Per	RI Par	RI Per	
1	none												
2													
3													
4													
5													
6													

Sample Analytical Note
 Procedure: tweased apart using forceps. Procedure: dissolution of matrix using dilute HCl acid.

Sample S-TOT-20B **Lab Number** 2008-02110- 41 **Sampled:** 3/6/2008 **Condition:** acceptable
Analyzed By LSP 4/3/2008 **An?** OK **Apparent Smp Type** Wall System **Non-fibrous Solid**
Homogeneous Yes **# Layers** 1 **Pos Layer?** No **# Sub-Samples** 3
Non-Fibrous Components (in approx. decreasing order): powder, ,

Layers					Percents of Each Fiber					
#	Layer Type	%	Color	Friability	Fib 1	Fib 2	Fib 3	Fib 4	Fib 5	Fib 6
1	texture/joint compound	100	white	3	n.d.	-	-	-	-	-
Total %		100	Average %		n.d.	-	-	-	-	-
Fiber Identification: none										

Fibers									Refractive Index Determinations				
#	Color	Mrph	Iso	Pleo	Bi	Elg	Ext	Oil	Col Par	Col Per	RI Par	RI Per	
1	none												
2													
3													
4													
5													
6													

Sample Analytical Note
 Procedure: tweased apart using forceps. Procedure: dissolution of matrix using dilute HCl acid.

Sample S-TOT-20C **Lab Number** 2008-02110- 42 **Sampled:** 3/6/2008 **Condition:** acceptable
Analyzed By LSP 4/3/2008 **An?** OK **Apparent Smp Type** Wall System **Non-fibrous Solid**
Homogeneous Yes **# Layers** 1 **Pos Layer?** No **# Sub-Samples** 3
Non-Fibrous Components (in approx. decreasing order): powder, ,

Layers					Percents of Each Fiber					
#	Layer Type	%	Color	Friability	Fib 1	Fib 2	Fib 3	Fib 4	Fib 5	Fib 6
1	texture/joint compound	100	white	3	n.d.	-	-	-	-	-
Total %		100	Average %		n.d.	-	-	-	-	-
Fiber Identification: none										

Fibers									Refractive Index Determinations				
#	Color	Mrph	Iso	Pleo	Bi	Elg	Ext	Oil	Col Par	Col Per	RI Par	RI Per	
1	none												
2													
3													
4													
5													
6													

Sample Analytical Note
 Procedure: tweased apart using forceps. Procedure: dissolution of matrix using dilute HCl acid.

PLM Analysis Details

Job Number: 200802110

08-085/Kyrene De La Esperanza

Sample M-GWB-21A **Lab Number** 2008-02110- 43 **Sampled:** 3/6/2008 **Condition:** acceptable
Analyzed By LSP 4/3/2008 **An?** OK **Apparent Smp Type** Wall System **Fibrous Solid**
Homogeneous Yes **# Layers** 1 **Pos Layer?** No **# Sub-Samples** 3
Non-Fibrous Components (in approx. decreasing order): powder, ,

Layers					Percents of Each Fiber					
#	Layer Type	%	Color	Friability	Fib 1	Fib 2	Fib 3	Fib 4	Fib 5	Fib 6
1	drywall core	100	white	3	<=1%	<=1%	-	-	-	-
Total %		100	Average %		<=1%	<=1%	-	-	-	-
Fiber Identification:					glass fiber	cellulose fiber				

Fibers									Refractive Index Determinations				
#	Layer Type	Color	Mrph	Iso	Pleo	Bi	Elg	Ext	Oil	Col Par	Col Per	RI Par	RI Per
1	glass fiber	CL	D	Y									
2	cellulose fiber	W	F	N	N	H	+	U					
3													
4													
5													
6													

Sample Analytical Note
 Procedure: tweased apart using forceps.

Sample M-GWB-21B **Lab Number** 2008-02110- 44 **Sampled:** 3/6/2008 **Condition:** acceptable
Analyzed By LSP 4/3/2008 **An?** OK **Apparent Smp Type** Wall System **Fibrous Solid**
Homogeneous Yes **# Layers** 1 **Pos Layer?** No **# Sub-Samples** 3
Non-Fibrous Components (in approx. decreasing order): powder, ,

Layers					Percents of Each Fiber					
#	Layer Type	%	Color	Friability	Fib 1	Fib 2	Fib 3	Fib 4	Fib 5	Fib 6
1	drywall core	100	white	3	<=1%	<=1%	-	-	-	-
Total %		100	Average %		<=1%	<=1%	-	-	-	-
Fiber Identification:					glass fiber	cellulose fiber				

Fibers									Refractive Index Determinations				
#	Layer Type	Color	Mrph	Iso	Pleo	Bi	Elg	Ext	Oil	Col Par	Col Per	RI Par	RI Per
1	glass fiber	CL	D	Y									
2	cellulose fiber	W	F	N	N	H	+	U					
3													
4													
5													
6													

Sample Analytical Note
 Procedure: tweased apart using forceps.

Sample M-GWB-21C **Lab Number** 2008-02110- 45 **Sampled:** 3/6/2008 **Condition:** acceptable
Analyzed By LSP 4/3/2008 **An?** OK **Apparent Smp Type** Wall System **Fibrous Solid**
Homogeneous Yes **# Layers** 1 **Pos Layer?** No **# Sub-Samples** 3
Non-Fibrous Components (in approx. decreasing order): powder, ,

Layers					Percents of Each Fiber					
#	Layer Type	%	Color	Friability	Fib 1	Fib 2	Fib 3	Fib 4	Fib 5	Fib 6
1	drywall core	100	white	3	<=1%	<=1%	-	-	-	-
Total %		100	Average %		<=1%	<=1%	-	-	-	-
Fiber Identification:					glass fiber	cellulose fiber				

Fibers									Refractive Index Determinations				
#	Layer Type	Color	Mrph	Iso	Pleo	Bi	Elg	Ext	Oil	Col Par	Col Per	RI Par	RI Per
1	glass fiber	CL	D	Y									
2	cellulose fiber	W	F	N	N	H	+	U					
3													
4													
5													
6													

Sample Analytical Note
 Procedure: tweased apart using forceps.

PLM Analysis Details

Job Number: 200802110 08-085/Kyrene De La Esperanza

Sample S-JTC-22A **Lab Number** 2008-02110- 46 **Sampled:** 3/6/2008 **Condition:** acceptable
Analyzed By LSP 4/3/2008 **An?** OK **Apparent Smp Type** Wall System **Non-fibrous Solid**
Homogeneous Yes **# Layers** 1 **Pos Layer?** No **# Sub-Samples** 3
Non-Fibrous Components (in approx. decreasing order): powder, ,

Layers					Percents of Each Fiber					
#	Layer Type	%	Color	Friability	Fib 1	Fib 2	Fib 3	Fib 4	Fib 5	Fib 6
1	texture/joint compound	100	white	3	n.d.	-	-	-	-	-
Total %		100	Average %		n.d.	-	-	-	-	-
Fiber Identification:					none					

Fibers									Refractive Index Determinations				
#	Color	Mrph	Iso	Pleo	Bi	Elg	Ext	Oil	Col Par	Col Per	RI Par	RI Per	
1	none												
2													
3													
4													
5													
6													

Sample Analytical Note
 Procedure: tweased apart using forceps. Procedure: dissolution of matrix using dilute HCl acid.

Sample S-JTC-22B **Lab Number** 2008-02110- 47 **Sampled:** 3/6/2008 **Condition:** acceptable
Analyzed By LSP 4/3/2008 **An?** OK **Apparent Smp Type** Wall System **Non-fibrous Solid**
Homogeneous Yes **# Layers** 1 **Pos Layer?** No **# Sub-Samples** 3
Non-Fibrous Components (in approx. decreasing order): powder, ,

Layers					Percents of Each Fiber					
#	Layer Type	%	Color	Friability	Fib 1	Fib 2	Fib 3	Fib 4	Fib 5	Fib 6
1	texture/joint compound	100	white	3	n.d.	-	-	-	-	-
Total %		100	Average %		n.d.	-	-	-	-	-
Fiber Identification:					none					

Fibers									Refractive Index Determinations				
#	Color	Mrph	Iso	Pleo	Bi	Elg	Ext	Oil	Col Par	Col Per	RI Par	RI Per	
1	none												
2													
3													
4													
5													
6													

Sample Analytical Note
 Procedure: tweased apart using forceps. Procedure: dissolution of matrix using dilute HCl acid.

Sample S-JTC-22C **Lab Number** 2008-02110- 48 **Sampled:** 3/6/2008 **Condition:** acceptable
Analyzed By LSP 4/3/2008 **An?** OK **Apparent Smp Type** Wall System **Non-fibrous Solid**
Homogeneous Yes **# Layers** 1 **Pos Layer?** No **# Sub-Samples** 3
Non-Fibrous Components (in approx. decreasing order): powder, ,

Layers					Percents of Each Fiber					
#	Layer Type	%	Color	Friability	Fib 1	Fib 2	Fib 3	Fib 4	Fib 5	Fib 6
1	texture/joint compound	100	white	3	n.d.	-	-	-	-	-
Total %		100	Average %		n.d.	-	-	-	-	-
Fiber Identification:					none					

Fibers									Refractive Index Determinations				
#	Color	Mrph	Iso	Pleo	Bi	Elg	Ext	Oil	Col Par	Col Per	RI Par	RI Per	
1	none												
2													
3													
4													
5													
6													

Sample Analytical Note
 Procedure: tweased apart using forceps. Procedure: dissolution of matrix using dilute HCl acid.

PLM Analysis Details

Job Number: 200802110 08-085/Kyrene De La Esperanza

Sample M-VCT-23A **Lab Number** 2008-02110- 49 **Sampled:** 3/6/2008 **Condition:** acceptable
Analyzed By LSP 4/3/2008 **An?** OK **Apparent Smp Type** Flooring **Non-fibrous Solid**
Homogeneous Yes **# Layers** 1 **Pos Layer?** No **# Sub-Samples** 3
Non-Fibrous Components (in approx. decreasing order): filler, binder,

Layers					Percents of Each Fiber					
#	Layer Type	%	Color	Friability	Fib 1	Fib 2	Fib 3	Fib 4	Fib 5	Fib 6
1	floor tile	100	off-white	1	n.d.	-	-	-	-	-
Total %		100	Average %		n.d.	-	-	-	-	-

Fiber Identification: none

Fibers									Refractive Index Determinations				
#	Color	Mrph	Iso	Pleo	Bi	Elg	Ext	Oil	Col Par	Col Per	RI Par	RI Per	
1	none												
2													
3													
4													
5													
6													

Sample Analytical Note
 Procedure: tweased apart using forceps. Procedure: dissolution of matrix using solvent.

Sample M-VCT-23B **Lab Number** 2008-02110- 50 **Sampled:** 3/6/2008 **Condition:** acceptable
Analyzed By LSP 4/3/2008 **An?** OK **Apparent Smp Type** Flooring **Non-fibrous Solid**
Homogeneous Yes **# Layers** 1 **Pos Layer?** No **# Sub-Samples** 3
Non-Fibrous Components (in approx. decreasing order): filler, binder,

Layers					Percents of Each Fiber					
#	Layer Type	%	Color	Friability	Fib 1	Fib 2	Fib 3	Fib 4	Fib 5	Fib 6
1	floor tile	100	off-white	1	n.d.	-	-	-	-	-
Total %		100	Average %		n.d.	-	-	-	-	-

Fiber Identification: none

Fibers									Refractive Index Determinations				
#	Color	Mrph	Iso	Pleo	Bi	Elg	Ext	Oil	Col Par	Col Per	RI Par	RI Per	
1	none												
2													
3													
4													
5													
6													

Sample Analytical Note
 Procedure: tweased apart using forceps. Procedure: dissolution of matrix using solvent.

Sample M-VCT-23C **Lab Number** 2008-02110- 51 **Sampled:** 3/6/2008 **Condition:** acceptable
Analyzed By LSP 4/3/2008 **An?** OK **Apparent Smp Type** Flooring **Non-fibrous Solid**
Homogeneous Yes **# Layers** 1 **Pos Layer?** No **# Sub-Samples** 3
Non-Fibrous Components (in approx. decreasing order): filler, binder,

Layers					Percents of Each Fiber					
#	Layer Type	%	Color	Friability	Fib 1	Fib 2	Fib 3	Fib 4	Fib 5	Fib 6
1	floor tile	100	off-white	1	n.d.	-	-	-	-	-
Total %		100	Average %		n.d.	-	-	-	-	-

Fiber Identification: none

Fibers									Refractive Index Determinations				
#	Color	Mrph	Iso	Pleo	Bi	Elg	Ext	Oil	Col Par	Col Per	RI Par	RI Per	
1	none												
2													
3													
4													
5													
6													

Sample Analytical Note
 Procedure: tweased apart using forceps. Procedure: dissolution of matrix using solvent.

PLM Analysis Details

Job Number: 200802110 08-085/Kyrene De La Esperanza

Sample M-MAS-24A **Lab Number** 2008-02110- 52 **Sampled:** 3/6/2008 **Condition:** acceptable
Analyzed By LSP 4/3/2008 **An?** OK **Apparent Smp Type** Adhesive/caulk **Non-fibrous Solid**
Homogeneous Yes **# Layers** 1 **Pos Layer?** No **# Sub-Samples** 3
Non-Fibrous Components (in approx. decreasing order): filler, polymer,

Layers					Percents of Each Fiber					
#	Layer Type	%	Color	Friability	Fib 1	Fib 2	Fib 3	Fib 4	Fib 5	Fib 6
1	mastic	100	tan	1	n.d.	-	-	-	-	-
Total %		100	Average %		n.d.	-	-	-	-	-
Fiber Identification:					none					

Fibers									Refractive Index Determinations				
#	Color	Mrph	Iso	Pleo	Bi	Elg	Ext	Oil	Col Par	Col Per	RI Par	RI Per	
1	none												
2													
3													
4													
5													
6													

Sample Analytical Note
 Procedure: tweased apart using forceps. Procedure: dissolution of matrix using solvent.

Sample M-MAS-24B **Lab Number** 2008-02110- 53 **Sampled:** 3/6/2008 **Condition:** acceptable
Analyzed By LSP 4/3/2008 **An?** OK **Apparent Smp Type** Adhesive/caulk **Non-fibrous Solid**
Homogeneous Yes **# Layers** 1 **Pos Layer?** No **# Sub-Samples** 3
Non-Fibrous Components (in approx. decreasing order): filler, polymer,

Layers					Percents of Each Fiber					
#	Layer Type	%	Color	Friability	Fib 1	Fib 2	Fib 3	Fib 4	Fib 5	Fib 6
1	mastic	100	tan	1	n.d.	-	-	-	-	-
Total %		100	Average %		n.d.	-	-	-	-	-
Fiber Identification:					none					

Fibers									Refractive Index Determinations				
#	Color	Mrph	Iso	Pleo	Bi	Elg	Ext	Oil	Col Par	Col Per	RI Par	RI Per	
1	none												
2													
3													
4													
5													
6													

Sample Analytical Note
 Procedure: tweased apart using forceps. Procedure: dissolution of matrix using solvent.

Sample M-MAS-24C **Lab Number** 2008-02110- 54 **Sampled:** 3/6/2008 **Condition:** acceptable
Analyzed By LSP 4/3/2008 **An?** OK **Apparent Smp Type** Adhesive/caulk **Non-fibrous Solid**
Homogeneous Yes **# Layers** 1 **Pos Layer?** No **# Sub-Samples** 3
Non-Fibrous Components (in approx. decreasing order): filler, polymer,

Layers					Percents of Each Fiber					
#	Layer Type	%	Color	Friability	Fib 1	Fib 2	Fib 3	Fib 4	Fib 5	Fib 6
1	mastic	100	tan	1	n.d.	-	-	-	-	-
Total %		100	Average %		n.d.	-	-	-	-	-
Fiber Identification:					none					

Fibers									Refractive Index Determinations				
#	Color	Mrph	Iso	Pleo	Bi	Elg	Ext	Oil	Col Par	Col Per	RI Par	RI Per	
1	none												
2													
3													
4													
5													
6													

Sample Analytical Note
 Procedure: tweased apart using forceps. Procedure: dissolution of matrix using solvent.

PLM Analysis Details

Job Number: 200802110

08-085/Kyrene De La Esperanza

Sample M-WAB-25A **Lab Number** 2008-02110- 55 **Sampled:** 3/6/2008 **Condition:** acceptable
Analyzed By LSP 4/3/2008 **An?** OK **Apparent Smp Type** Miscellaneous Non-fibrous Solid
Homogeneous Yes **# Layers** 1 **Pos Layer?** No **# Sub-Samples** 3
Non-Fibrous Components (in approx. decreasing order): polymer, filler,

Layers					Percents of Each Fiber					
#	Layer Type	%	Color	Friability	Fib 1	Fib 2	Fib 3	Fib 4	Fib 5	Fib 6
1	base cov	100	Blue	1	n.d.	-	-	-	-	-
Total %		100	Average %		n.d.	-	-	-	-	-
Fiber Identification:					none					

Fibers									Refractive Index Determinations				
#	Color	Mrph	Iso	Pleo	Bi	Elg	Ext	Oil	Col Par	Col Per	RI Par	RI Per	
1	none												
2													
3													
4													
5													
6													

Sample Analytical Note
 Procedure: tweased apart using forceps. Procedure: dissolution of matrix using solvent.

Sample M-WAB-25B **Lab Number** 2008-02110- 56 **Sampled:** 3/6/2008 **Condition:** acceptable
Analyzed By LSP 4/3/2008 **An?** OK **Apparent Smp Type** Miscellaneous Non-fibrous Solid
Homogeneous Yes **# Layers** 1 **Pos Layer?** No **# Sub-Samples** 3
Non-Fibrous Components (in approx. decreasing order): polymer, filler,

Layers					Percents of Each Fiber					
#	Layer Type	%	Color	Friability	Fib 1	Fib 2	Fib 3	Fib 4	Fib 5	Fib 6
1	base cov	100	Blue	1	n.d.	-	-	-	-	-
Total %		100	Average %		n.d.	-	-	-	-	-
Fiber Identification:					none					

Fibers									Refractive Index Determinations				
#	Color	Mrph	Iso	Pleo	Bi	Elg	Ext	Oil	Col Par	Col Per	RI Par	RI Per	
1	none												
2													
3													
4													
5													
6													

Sample Analytical Note
 Procedure: tweased apart using forceps. Procedure: dissolution of matrix using solvent.

Sample M-WAB-25C **Lab Number** 2008-02110- 57 **Sampled:** 3/6/2008 **Condition:** acceptable
Analyzed By LSP 4/3/2008 **An?** OK **Apparent Smp Type** Miscellaneous Non-fibrous Solid
Homogeneous Yes **# Layers** 1 **Pos Layer?** No **# Sub-Samples** 3
Non-Fibrous Components (in approx. decreasing order): polymer, filler,

Layers					Percents of Each Fiber					
#	Layer Type	%	Color	Friability	Fib 1	Fib 2	Fib 3	Fib 4	Fib 5	Fib 6
1	base cov	100	Blue	1	n.d.	-	-	-	-	-
Total %		100	Average %		n.d.	-	-	-	-	-
Fiber Identification:					none					

Fibers									Refractive Index Determinations				
#	Color	Mrph	Iso	Pleo	Bi	Elg	Ext	Oil	Col Par	Col Per	RI Par	RI Per	
1	none												
2													
3													
4													
5													
6													

Sample Analytical Note
 Procedure: tweased apart using forceps. Procedure: dissolution of matrix using solvent.

PLM Analysis Details

Job Number: 200802110 08-085/Kyrene De La Esperanza

Sample M-ADH-26A **Lab Number** 2008-02110- 58 **Sampled:** 3/6/2008 **Condition:** acceptable
Analyzed By LSP 4/3/2008 **An?** OK **Apparent Smp Type** Adhesive/caulk **Non-fibrous Solid**
Homogeneous Yes **# Layers** 1 **Pos Layer?** No **# Sub-Samples** 3
Non-Fibrous Components (in approx. decreasing order): filler, polymer,

Layers					Percents of Each Fiber					
#	Layer Type	%	Color	Friability	Fib 1	Fib 2	Fib 3	Fib 4	Fib 5	Fib 6
1	mastic	100	Off-white	1	n.d.	-	-	-	-	-
Total %		100	Average %		n.d.	-	-	-	-	-
Fiber Identification:					none					

Fibers									Refractive Index Determinations				
#	Color	Mrph	Iso	Pleo	Bi	Elg	Ext	Oil	Col Par	Col Per	RI Par	RI Per	
1	none												
2													
3													
4													
5													
6													

Sample Analytical Note
 Procedure: tweased apart using forceps. Procedure: dissolution of matrix using solvent.

Sample M-ADH-26B **Lab Number** 2008-02110- 59 **Sampled:** 3/6/2008 **Condition:** acceptable
Analyzed By LSP 4/3/2008 **An?** OK **Apparent Smp Type** Adhesive/caulk **Non-fibrous Solid**
Homogeneous Yes **# Layers** 1 **Pos Layer?** No **# Sub-Samples** 3
Non-Fibrous Components (in approx. decreasing order): filler, polymer,

Layers					Percents of Each Fiber					
#	Layer Type	%	Color	Friability	Fib 1	Fib 2	Fib 3	Fib 4	Fib 5	Fib 6
1	mastic	100	Off-white	1	n.d.	-	-	-	-	-
Total %		100	Average %		n.d.	-	-	-	-	-
Fiber Identification:					none					

Fibers									Refractive Index Determinations				
#	Color	Mrph	Iso	Pleo	Bi	Elg	Ext	Oil	Col Par	Col Per	RI Par	RI Per	
1	none												
2													
3													
4													
5													
6													

Sample Analytical Note
 Procedure: tweased apart using forceps. Procedure: dissolution of matrix using solvent.

Sample M-ADH-26C **Lab Number** 2008-02110- 60 **Sampled:** 3/6/2008 **Condition:** acceptable
Analyzed By LSP 4/3/2008 **An?** OK **Apparent Smp Type** Adhesive/caulk **Non-fibrous Solid**
Homogeneous Yes **# Layers** 1 **Pos Layer?** No **# Sub-Samples** 3
Non-Fibrous Components (in approx. decreasing order): filler, polymer,

Layers					Percents of Each Fiber					
#	Layer Type	%	Color	Friability	Fib 1	Fib 2	Fib 3	Fib 4	Fib 5	Fib 6
1	mastic	100	Off-white	1	n.d.	-	-	-	-	-
Total %		100	Average %		n.d.	-	-	-	-	-
Fiber Identification:					none					

Fibers									Refractive Index Determinations				
#	Color	Mrph	Iso	Pleo	Bi	Elg	Ext	Oil	Col Par	Col Per	RI Par	RI Per	
1	none												
2													
3													
4													
5													
6													

Sample Analytical Note
 Procedure: tweased apart using forceps. Procedure: dissolution of matrix using solvent.

PLM Analysis Details

Job Number: 200802110 08-085/Kyrene De La Esperanza

Sample S-SAT-29A **Lab Number** 2008-02110- 61 **Sampled:** 3/6/2008 **Condition:** acceptable
Analyzed By LSP 4/3/2008 **An?** OK **Apparent Smp Type** Wall System Non-fibrous Solid
Homogeneous Yes **# Layers** 1 **Pos Layer?** No **# Sub-Samples** 3
Non-Fibrous Components (in approx. decreasing order): powder, ,

Layers					Percents of Each Fiber					
#	Layer Type	%	Color	Friability	Fib 1	Fib 2	Fib 3	Fib 4	Fib 5	Fib 6
1	texture/joint compound	100	white	3	n.d.	-	-	-	-	-
Total %		100	Average %		n.d.	-	-	-	-	-
Fiber Identification: none										

Fibers									Refractive Index Determinations				
#	Color	Mrph	Iso	Pleo	Bi	Elg	Ext	Oil	Col Par	Col Per	RI Par	RI Per	
1	none												
2													
3													
4													
5													
6													

Sample Analytical Note
 Procedure: tweased apart using forceps. Procedure: dissolution of matrix using dilute HCl acid. Very thin layer of texture. Sample is mostly paint.

Sample S-SAT-29B **Lab Number** 2008-02110- 62 **Sampled:** 3/6/2008 **Condition:** acceptable
Analyzed By LSP 4/3/2008 **An?** OK **Apparent Smp Type** Wall System Non-fibrous Solid
Homogeneous Yes **# Layers** 1 **Pos Layer?** No **# Sub-Samples** 3
Non-Fibrous Components (in approx. decreasing order): powder, ,

Layers					Percents of Each Fiber					
#	Layer Type	%	Color	Friability	Fib 1	Fib 2	Fib 3	Fib 4	Fib 5	Fib 6
1	texture/joint compound	100	white	3	n.d.	-	-	-	-	-
Total %		100	Average %		n.d.	-	-	-	-	-
Fiber Identification: none										

Fibers									Refractive Index Determinations				
#	Color	Mrph	Iso	Pleo	Bi	Elg	Ext	Oil	Col Par	Col Per	RI Par	RI Per	
1	none												
2													
3													
4													
5													
6													

Sample Analytical Note
 Procedure: tweased apart using forceps. Procedure: dissolution of matrix using dilute HCl acid. Very thin layer of texture. Sample is mostly paint.

Sample S-SAT-29C **Lab Number** 2008-02110- 63 **Sampled:** 3/6/2008 **Condition:** acceptable
Analyzed By LSP 4/3/2008 **An?** OK **Apparent Smp Type** Wall System Non-fibrous Solid
Homogeneous Yes **# Layers** 1 **Pos Layer?** No **# Sub-Samples** 3
Non-Fibrous Components (in approx. decreasing order): powder, ,

Layers					Percents of Each Fiber					
#	Layer Type	%	Color	Friability	Fib 1	Fib 2	Fib 3	Fib 4	Fib 5	Fib 6
1	texture/joint compound	100	white	3	n.d.	-	-	-	-	-
Total %		100	Average %		n.d.	-	-	-	-	-
Fiber Identification: none										

Fibers									Refractive Index Determinations				
#	Color	Mrph	Iso	Pleo	Bi	Elg	Ext	Oil	Col Par	Col Per	RI Par	RI Per	
1	none												
2													
3													
4													
5													
6													

Sample Analytical Note
 Procedure: tweased apart using forceps. Procedure: dissolution of matrix using dilute HCl acid. Very thin layer of texture. Sample is mostly paint.

PLM Analysis Details

Job Number: 200802110 08-085/Kyrene De La Esperanza

Sample M-GWB-30A **Lab Number** 2008-02110- 64 **Sampled:** 3/6/2008 **Condition:** acceptable
Analyzed By LSP 4/3/2008 **An?** OK **Apparent Smp Type** Wall System **Fibrous Solid**
Homogeneous Yes **# Layers** 1 **Pos Layer?** No **# Sub-Samples** 3
Non-Fibrous Components (in approx. decreasing order): powder, ,

Layers					Percents of Each Fiber					
#	Layer Type	%	Color	Friability	Fib 1	Fib 2	Fib 3	Fib 4	Fib 5	Fib 6
1	drywall core	100	Tan	3	<=1%	<=1%	-	-	-	-
Total %		100	Average %		<=1%	<=1%	-	-	-	-
Fiber Identification:					glass fiber	cellulose fiber				

Fibers									Refractive Index Determinations				
#	Color	Mrph	Iso	Pleo	Bi	Elg	Ext		Oil	Col Par	Col Per	RI Par	RI Per
1	CL	D	Y										
2	W	F	N	N	H	+	U						
3													
4													
5													
6													

Sample Analytical Note
 Procedure: tweased apart using forceps.

Sample M-GWB-30B **Lab Number** 2008-02110- 65 **Sampled:** 3/6/2008 **Condition:** acceptable
Analyzed By LSP 4/3/2008 **An?** OK **Apparent Smp Type** Wall System **Fibrous Solid**
Homogeneous Yes **# Layers** 1 **Pos Layer?** No **# Sub-Samples** 3
Non-Fibrous Components (in approx. decreasing order): powder, ,

Layers					Percents of Each Fiber					
#	Layer Type	%	Color	Friability	Fib 1	Fib 2	Fib 3	Fib 4	Fib 5	Fib 6
1	drywall core	100	Tan	3	<=1%	<=1%	-	-	-	-
Total %		100	Average %		<=1%	<=1%	-	-	-	-
Fiber Identification:					glass fiber	cellulose fiber				

Fibers									Refractive Index Determinations				
#	Color	Mrph	Iso	Pleo	Bi	Elg	Ext		Oil	Col Par	Col Per	RI Par	RI Per
1	CL	D	Y										
2	W	F	N	N	H	+	U						
3													
4													
5													
6													

Sample Analytical Note
 Procedure: tweased apart using forceps.

Sample M-GWB-30C **Lab Number** 2008-02110- 66 **Sampled:** 3/6/2008 **Condition:** acceptable
Analyzed By LSP 4/3/2008 **An?** OK **Apparent Smp Type** Wall System **Fibrous Solid**
Homogeneous Yes **# Layers** 1 **Pos Layer?** No **# Sub-Samples** 3
Non-Fibrous Components (in approx. decreasing order): powder, ,

Layers					Percents of Each Fiber					
#	Layer Type	%	Color	Friability	Fib 1	Fib 2	Fib 3	Fib 4	Fib 5	Fib 6
1	drywall core	100	Tan	3	<=1%	<=1%	-	-	-	-
Total %		100	Average %		<=1%	<=1%	-	-	-	-
Fiber Identification:					glass fiber	cellulose fiber				

Fibers									Refractive Index Determinations				
#	Color	Mrph	Iso	Pleo	Bi	Elg	Ext		Oil	Col Par	Col Per	RI Par	RI Per
1	CL	D	Y										
2	W	F	N	N	H	+	U						
3													
4													
5													
6													

Sample Analytical Note
 Procedure: tweased apart using forceps.

PLM Analysis Details

Job Number: 200802110

08-085/Kyrene De La Esperanza

Sample S-JTC-31A **Lab Number** 2008-02110- 67 **Sampled:** 3/6/2008 **Condition:** acceptable
Analyzed By LSP 4/3/2008 **An?** OK **Apparent Smp Type** Wall System Non-fibrous Solid
Homogeneous Yes **# Layers** 1 **Pos Layer?** No **# Sub-Samples** 3
Non-Fibrous Components (in approx. decreasing order): powder, ,

Layers					Percents of Each Fiber					
#	Layer Type	%	Color	Friability	Fib 1	Fib 2	Fib 3	Fib 4	Fib 5	Fib 6
1	texture/joint compound	100	white	3	n.d.	-	-	-	-	-
Total %		100	Average %		n.d.	-	-	-	-	-
Fiber Identification: none										

Fibers									Refractive Index Determinations				
#	Color	Mrph	Iso	Pleo	Bi	Elg	Ext	Oil	Col Par	Col Per	RI Par	RI Per	
1	none												
2													
3													
4													
5													
6													

Sample Analytical Note
 Procedure: teased apart using forceps. Procedure: dissolution of matrix using dilute HCl acid.

Sample S-JTC-31B **Lab Number** 2008-02110- 68 **Sampled:** 3/6/2008 **Condition:** acceptable
Analyzed By LSP 4/3/2008 **An?** OK **Apparent Smp Type** Wall System Non-fibrous Solid
Homogeneous Yes **# Layers** 1 **Pos Layer?** No **# Sub-Samples** 3
Non-Fibrous Components (in approx. decreasing order): powder, ,

Layers					Percents of Each Fiber					
#	Layer Type	%	Color	Friability	Fib 1	Fib 2	Fib 3	Fib 4	Fib 5	Fib 6
1	texture/joint compound	100	white	3	n.d.	-	-	-	-	-
Total %		100	Average %		n.d.	-	-	-	-	-
Fiber Identification: none										

Fibers									Refractive Index Determinations				
#	Color	Mrph	Iso	Pleo	Bi	Elg	Ext	Oil	Col Par	Col Per	RI Par	RI Per	
1	none												
2													
3													
4													
5													
6													

Sample Analytical Note
 Procedure: teased apart using forceps. Procedure: dissolution of matrix using dilute HCl acid.

Sample S-JTC-31C **Lab Number** 2008-02110- 69 **Sampled:** 3/6/2008 **Condition:** acceptable
Analyzed By LSP 4/3/2008 **An?** OK **Apparent Smp Type** Wall System Non-fibrous Solid
Homogeneous Yes **# Layers** 1 **Pos Layer?** No **# Sub-Samples** 3
Non-Fibrous Components (in approx. decreasing order): powder, ,

Layers					Percents of Each Fiber					
#	Layer Type	%	Color	Friability	Fib 1	Fib 2	Fib 3	Fib 4	Fib 5	Fib 6
1	texture/joint compound	100	white	3	n.d.	-	-	-	-	-
Total %		100	Average %		n.d.	-	-	-	-	-
Fiber Identification: none										

Fibers									Refractive Index Determinations				
#	Color	Mrph	Iso	Pleo	Bi	Elg	Ext	Oil	Col Par	Col Per	RI Par	RI Per	
1	none												
2													
3													
4													
5													
6													

Sample Analytical Note
 Procedure: teased apart using forceps. Procedure: dissolution of matrix using dilute HCl acid.

PLM Analysis Details

Job Number: 200802110 08-085/Kyrene De La Esperanza

Sample M-SLT-32A **Lab Number** 2008-02110- 70 **Sampled:** 3/6/2008 **Condition:** acceptable
Analyzed By LSP 4/3/2008 **An?** OK **Apparent Smp Type** Adhesive/caulk **Non-fibrous Solid**
Homogeneous Yes **# Layers** 1 **Pos Layer?** No **# Sub-Samples** 3
Non-Fibrous Components (in approx. decreasing order): filler, binder,

Layers					Percents of Each Fiber					
#	Layer Type	%	Color	Friability	Fib 1	Fib 2	Fib 3	Fib 4	Fib 5	Fib 6
1	caulk	100	white	1	n.d.	-	-	-	-	-
Total %		100	Average %		n.d.	-	-	-	-	-
Fiber Identification:					none					

Fibers									Refractive Index Determinations				
#	Color	Mrph	Iso	Pleo	Bi	Elg	Ext	Oil	Col Par	Col Per	RI Par	RI Per	
1	none												
2													
3													
4													
5													
6													

Sample Analytical Note
 Procedure: teased apart using forceps. Procedure: dissolution of matrix using solvent.

Sample M-SLT-32B **Lab Number** 2008-02110- 71 **Sampled:** 3/6/2008 **Condition:** acceptable
Analyzed By LSP 4/3/2008 **An?** OK **Apparent Smp Type** Adhesive/caulk **Non-fibrous Solid**
Homogeneous Yes **# Layers** 1 **Pos Layer?** No **# Sub-Samples** 3
Non-Fibrous Components (in approx. decreasing order): filler, binder,

Layers					Percents of Each Fiber					
#	Layer Type	%	Color	Friability	Fib 1	Fib 2	Fib 3	Fib 4	Fib 5	Fib 6
1	caulk	100	white	1	n.d.	-	-	-	-	-
Total %		100	Average %		n.d.	-	-	-	-	-
Fiber Identification:					none					

Fibers									Refractive Index Determinations				
#	Color	Mrph	Iso	Pleo	Bi	Elg	Ext	Oil	Col Par	Col Per	RI Par	RI Per	
1	none												
2													
3													
4													
5													
6													

Sample Analytical Note
 Procedure: teased apart using forceps. Procedure: dissolution of matrix using solvent.

Sample M-SLT-32C **Lab Number** 2008-02110- 72 **Sampled:** 3/6/2008 **Condition:** acceptable
Analyzed By LSP 4/3/2008 **An?** OK **Apparent Smp Type** Adhesive/caulk **Non-fibrous Solid**
Homogeneous Yes **# Layers** 1 **Pos Layer?** No **# Sub-Samples** 3
Non-Fibrous Components (in approx. decreasing order): filler, binder,

Layers					Percents of Each Fiber					
#	Layer Type	%	Color	Friability	Fib 1	Fib 2	Fib 3	Fib 4	Fib 5	Fib 6
1	caulk	100	white	1	n.d.	-	-	-	-	-
Total %		100	Average %		n.d.	-	-	-	-	-
Fiber Identification:					none					

Fibers									Refractive Index Determinations				
#	Color	Mrph	Iso	Pleo	Bi	Elg	Ext	Oil	Col Par	Col Per	RI Par	RI Per	
1	none												
2													
3													
4													
5													
6													

Sample Analytical Note
 Procedure: teased apart using forceps. Procedure: dissolution of matrix using solvent.

PLM Analysis Details

Job Number: 200802110 08-085/Kyrene De La Esperanza

Sample M-CPT-33A **Lab Number** 2008-02110- 73 **Sampled:** 3/6/2008 **Condition:** acceptable
Analyzed By LSP 4/3/2008 **An?** OK **Apparent Smp Type** Carpet **Fibrous Mat**
Homogeneous Yes **# Layers** 1 **Pos Layer?** No **# Sub-Samples** 3
Non-Fibrous Components (in approx. decreasing order): filler, powder, binder

Layers					Percents of Each Fiber					
#	Layer Type	%	Color	Friability	Fib 1	Fib 2	Fib 3	Fib 4	Fib 5	Fib 6
1	carpet	100	various	1	50-60%	-	-	-	-	-
Total %		100	Average %		50-60%	-	-	-	-	-
Fiber Identification:					synthetic fiber (extr)					

Fibers									Refractive Index Determinations				
#	Color	Mrph	Iso	Pleo	Bi	Elg	Ext		Oil	Col Par	Col Per	RI Par	RI Per
1	synthetic fiber (extruded)	V	E	N	N	H	+	P					
2													
3													
4													
5													
6													

Sample Analytical Note
 Procedure: tweased apart using forceps.

Sample M-CPT-33B **Lab Number** 2008-02110- 74 **Sampled:** 3/6/2008 **Condition:** acceptable
Analyzed By LSP 4/3/2008 **An?** OK **Apparent Smp Type** Carpet **Fibrous Mat**
Homogeneous Yes **# Layers** 1 **Pos Layer?** No **# Sub-Samples** 3
Non-Fibrous Components (in approx. decreasing order): filler, powder, binder

Layers					Percents of Each Fiber					
#	Layer Type	%	Color	Friability	Fib 1	Fib 2	Fib 3	Fib 4	Fib 5	Fib 6
1	carpet	100	various	1	50-60%	-	-	-	-	-
Total %		100	Average %		50-60%	-	-	-	-	-
Fiber Identification:					synthetic fiber (extr)					

Fibers									Refractive Index Determinations				
#	Color	Mrph	Iso	Pleo	Bi	Elg	Ext		Oil	Col Par	Col Per	RI Par	RI Per
1	synthetic fiber (extruded)	V	E	N	N	H	+	P					
2													
3													
4													
5													
6													

Sample Analytical Note
 Procedure: tweased apart using forceps.

Sample M-CPT-33C **Lab Number** 2008-02110- 75 **Sampled:** 3/6/2008 **Condition:** acceptable
Analyzed By LSP 4/3/2008 **An?** OK **Apparent Smp Type** Carpet **Fibrous Mat**
Homogeneous Yes **# Layers** 1 **Pos Layer?** No **# Sub-Samples** 3
Non-Fibrous Components (in approx. decreasing order): filler, powder, binder

Layers					Percents of Each Fiber					
#	Layer Type	%	Color	Friability	Fib 1	Fib 2	Fib 3	Fib 4	Fib 5	Fib 6
1	carpet	100	various	1	50-60%	-	-	-	-	-
Total %		100	Average %		50-60%	-	-	-	-	-
Fiber Identification:					synthetic fiber (extr)					

Fibers									Refractive Index Determinations				
#	Color	Mrph	Iso	Pleo	Bi	Elg	Ext		Oil	Col Par	Col Per	RI Par	RI Per
1	synthetic fiber (extruded)	V	E	N	N	H	+	P					
2													
3													
4													
5													
6													

Sample Analytical Note
 Procedure: tweased apart using forceps.

PLM Analysis Details

Job Number: 200802110 08-085/Kyrene De La Esperanza

Sample M-APL-35A **Lab Number** 2008-02110- 76 **Sampled:** 3/6/2008 **Condition:** acceptable
Analyzed By LSP 4/3/2008 **An?** OK **Apparent Smp Type** Ceiling Tile **Fibrous Mat**
Homogeneous Yes **# Layers** 1 **Pos Layer?** No **# Sub-Samples** 3
Non-Fibrous Components (in approx. decreasing order): perlite, powder, binder

Layers					Percents of Each Fiber					
#	Layer Type	%	Color	Friability	Fib 1	Fib 2	Fib 3	Fib 4	Fib 5	Fib 6
1	ceiling tile	100	Tan	3	20-30%	2-5%	-	-	-	-
Total %		100	Average %		20-30%	2-5%	-	-	-	-
Fiber Identification:					cellulose fiber	glass fiber				

Fibers									Refractive Index Determinations				
#	Layer Type	Color	Mrph	Iso	Pleo	Bi	Elg	Ext	Oil	Col Par	Col Per	RI Par	RI Per
1	cellulose fiber	W	F	N	N	H	+	U					
2	glass fiber	CL	D	Y									
3													
4													
5													
6													

Sample Analytical Note
 Procedure: tweased apart using forceps. Procedure: dissolution of matrix using acid.

Sample M-APL-35B **Lab Number** 2008-02110- 77 **Sampled:** 3/6/2008 **Condition:** acceptable
Analyzed By LSP 4/3/2008 **An?** OK **Apparent Smp Type** Ceiling Tile **Fibrous Mat**
Homogeneous Yes **# Layers** 1 **Pos Layer?** No **# Sub-Samples** 3
Non-Fibrous Components (in approx. decreasing order): perlite, powder, binder

Layers					Percents of Each Fiber					
#	Layer Type	%	Color	Friability	Fib 1	Fib 2	Fib 3	Fib 4	Fib 5	Fib 6
1	ceiling tile	100	Tan	3	20-30%	2-5%	-	-	-	-
Total %		100	Average %		20-30%	2-5%	-	-	-	-
Fiber Identification:					cellulose fiber	glass fiber				

Fibers									Refractive Index Determinations				
#	Layer Type	Color	Mrph	Iso	Pleo	Bi	Elg	Ext	Oil	Col Par	Col Per	RI Par	RI Per
1	cellulose fiber	W	F	N	N	H	+	U					
2	glass fiber	CL	D	Y									
3													
4													
5													
6													

Sample Analytical Note
 Procedure: tweased apart using forceps. Procedure: dissolution of matrix using acid.

Sample M-APL-35C **Lab Number** 2008-02110- 78 **Sampled:** 3/6/2008 **Condition:** acceptable
Analyzed By LSP 4/3/2008 **An?** OK **Apparent Smp Type** Ceiling Tile **Fibrous Mat**
Homogeneous Yes **# Layers** 1 **Pos Layer?** No **# Sub-Samples** 3
Non-Fibrous Components (in approx. decreasing order): perlite, powder, binder

Layers					Percents of Each Fiber					
#	Layer Type	%	Color	Friability	Fib 1	Fib 2	Fib 3	Fib 4	Fib 5	Fib 6
1	ceiling tile	100	Tan	3	20-30%	2-5%	-	-	-	-
Total %		100	Average %		20-30%	2-5%	-	-	-	-
Fiber Identification:					cellulose fiber	glass fiber				

Fibers									Refractive Index Determinations				
#	Layer Type	Color	Mrph	Iso	Pleo	Bi	Elg	Ext	Oil	Col Par	Col Per	RI Par	RI Per
1	cellulose fiber	W	F	N	N	H	+	U					
2	glass fiber	CL	D	Y									
3													
4													
5													
6													

Sample Analytical Note
 Procedure: tweased apart using forceps. Procedure: dissolution of matrix using acid.

PLM Analysis Details

Job Number: 200802110 08-085/Kyrene De La Esperanza

Sample S-SAT-36A **Lab Number** 2008-02110- 79 **Sampled:** 3/6/2008 **Condition:** acceptable
Analyzed By LSP 4/3/2008 **An?** OK **Apparent Smp Type** Wall System **Non-fibrous Solid**
Homogeneous Yes **# Layers** 1 **Pos Layer?** No **# Sub-Samples** 3
Non-Fibrous Components (in approx. decreasing order): powder, ,

Layers					Percents of Each Fiber					
#	Layer Type	%	Color	Friability	Fib 1	Fib 2	Fib 3	Fib 4	Fib 5	Fib 6
1	texture/joint compound	100	white	3	n.d.	-	-	-	-	-
Total %		100	Average %		n.d.	-	-	-	-	-
Fiber Identification:					none					

Fibers									Refractive Index Determinations				
#	Color	Mrph	Iso	Pleo	Bi	Elg	Ext	Oil	Col Par	Col Per	RI Par	RI Per	
1	none												
2													
3													
4													
5													
6													

Sample Analytical Note
 Procedure: tweased apart using forceps. Procedure: dissolution of matrix using dilute HCl acid. Very thin layer. Note: sample size was too small - analysis may not be representative of whole.

Sample S-SAT-36B **Lab Number** 2008-02110- 80 **Sampled:** 3/6/2008 **Condition:** acceptable
Analyzed By LSP 4/3/2008 **An?** OK **Apparent Smp Type** Wall System **Non-fibrous Solid**
Homogeneous Yes **# Layers** 1 **Pos Layer?** No **# Sub-Samples** 3
Non-Fibrous Components (in approx. decreasing order): powder, ,

Layers					Percents of Each Fiber					
#	Layer Type	%	Color	Friability	Fib 1	Fib 2	Fib 3	Fib 4	Fib 5	Fib 6
1	texture/joint compound	100	white	3	n.d.	-	-	-	-	-
Total %		100	Average %		n.d.	-	-	-	-	-
Fiber Identification:					none					

Fibers									Refractive Index Determinations				
#	Color	Mrph	Iso	Pleo	Bi	Elg	Ext	Oil	Col Par	Col Per	RI Par	RI Per	
1	none												
2													
3													
4													
5													
6													

Sample Analytical Note
 Procedure: tweased apart using forceps. Procedure: dissolution of matrix using dilute HCl acid. Very thin layer. Note: sample size was too small - analysis may not be representative of whole.

Sample S-SAT-36C **Lab Number** 2008-02110- 81 **Sampled:** 3/6/2008 **Condition:** acceptable
Analyzed By LSP 4/3/2008 **An?** OK **Apparent Smp Type** Wall System **Non-fibrous Solid**
Homogeneous Yes **# Layers** 1 **Pos Layer?** No **# Sub-Samples** 3
Non-Fibrous Components (in approx. decreasing order): powder, ,

Layers					Percents of Each Fiber					
#	Layer Type	%	Color	Friability	Fib 1	Fib 2	Fib 3	Fib 4	Fib 5	Fib 6
1	texture/joint compound	100	white	3	n.d.	-	-	-	-	-
Total %		100	Average %		n.d.	-	-	-	-	-
Fiber Identification:					none					

Fibers									Refractive Index Determinations				
#	Color	Mrph	Iso	Pleo	Bi	Elg	Ext	Oil	Col Par	Col Per	RI Par	RI Per	
1	none												
2													
3													
4													
5													
6													

Sample Analytical Note
 Procedure: tweased apart using forceps. Procedure: dissolution of matrix using dilute HCl acid. Very thin layer. Note: sample size was too small - analysis may not be representative of whole.

PLM Analysis Details

Job Number: 200802110

08-085/Kyrene De La Esperanza

Sample M-GWB-37A Lab Number 2008-02110- 82 Sampled: 3/6/2008 Condition: acceptable
Analyzed By LSP 4/3/2008 An? OK Apparent Smp Type Wall System Fibrous Solid
Homogeneous Yes # Layers 1 Pos Layer? No # Sub-Samples 3
Non-Fibrous Components (in approx. decreasing order): powder, ,

Layers table with columns: #, Layer Type, %, Color, Friability, Fib 1-6. Includes Total % and Average % rows.

Fibers table with columns: #, Color, Mrph, Iso, Pleo, Bi, Elg, Ext, and Refractive Index Determinations (Oil, Col Par, Col Per, RI Par, RI Per).

Sample Analytical Note
Procedure: tweased apart using forceps.

Sample M-GWB-37B Lab Number 2008-02110- 83 Sampled: 3/6/2008 Condition: acceptable
Analyzed By LSP 4/3/2008 An? OK Apparent Smp Type Wall System Fibrous Solid
Homogeneous Yes # Layers 1 Pos Layer? No # Sub-Samples 3
Non-Fibrous Components (in approx. decreasing order): powder, ,

Layers table with columns: #, Layer Type, %, Color, Friability, Fib 1-6. Includes Total % and Average % rows.

Fibers table with columns: #, Color, Mrph, Iso, Pleo, Bi, Elg, Ext, and Refractive Index Determinations (Oil, Col Par, Col Per, RI Par, RI Per).

Sample Analytical Note
Procedure: tweased apart using forceps.

Sample M-GWB-37C Lab Number 2008-02110- 84 Sampled: 3/6/2008 Condition: acceptable
Analyzed By LSP 4/3/2008 An? OK Apparent Smp Type Wall System Fibrous Solid
Homogeneous Yes # Layers 1 Pos Layer? No # Sub-Samples 3
Non-Fibrous Components (in approx. decreasing order): powder, ,

Layers table with columns: #, Layer Type, %, Color, Friability, Fib 1-6. Includes Total % and Average % rows.

Fibers table with columns: #, Color, Mrph, Iso, Pleo, Bi, Elg, Ext, and Refractive Index Determinations (Oil, Col Par, Col Per, RI Par, RI Per).

Sample Analytical Note
Procedure: tweased apart using forceps.

PLM Analysis Details

Job Number: 200802110 08-085/Kyrene De La Esperanza

Sample S-JTC-38A **Lab Number** 2008-02110- 85 **Sampled:** 3/6/2008 **Condition:** acceptable
Analyzed By LSP 4/3/2008 **An?** OK **Apparent Smp Type** Wall System **Non-fibrous Solid**
Homogeneous Yes **# Layers** 1 **Pos Layer?** No **# Sub-Samples** 3
Non-Fibrous Components (in approx. decreasing order): powder, ,

Layers					Percents of Each Fiber					
#	Layer Type	%	Color	Friability	Fib 1	Fib 2	Fib 3	Fib 4	Fib 5	Fib 6
1	texture/joint compound	100	white	3	n.d.	-	-	-	-	-
Total %		100	Average %		n.d.	-	-	-	-	-

Fiber Identification: none

Fibers									Refractive Index Determinations				
#	Color	Mrph	Iso	Pleo	Bi	Elg	Ext	Oil	Col Par	Col Per	RI Par	RI Per	
1	none												
2													
3													
4													
5													
6													

Sample Analytical Note

Procedure: tweased apart using forceps. Procedure: dissolution of matrix using dilute HCl acid.

Sample S-JTC-38B **Lab Number** 2008-02110- 86 **Sampled:** 3/6/2008 **Condition:** acceptable
Analyzed By LSP 4/3/2008 **An?** OK **Apparent Smp Type** Wall System **Non-fibrous Solid**
Homogeneous Yes **# Layers** 1 **Pos Layer?** No **# Sub-Samples** 3
Non-Fibrous Components (in approx. decreasing order): powder, ,

Layers					Percents of Each Fiber					
#	Layer Type	%	Color	Friability	Fib 1	Fib 2	Fib 3	Fib 4	Fib 5	Fib 6
1	texture/joint compound	100	white	3	n.d.	-	-	-	-	-
Total %		100	Average %		n.d.	-	-	-	-	-

Fiber Identification: none

Fibers									Refractive Index Determinations				
#	Color	Mrph	Iso	Pleo	Bi	Elg	Ext	Oil	Col Par	Col Per	RI Par	RI Per	
1	none												
2													
3													
4													
5													
6													

Sample Analytical Note

Procedure: tweased apart using forceps. Procedure: dissolution of matrix using dilute HCl acid.

Sample S-JTC-38C **Lab Number** 2008-02110- 87 **Sampled:** 3/6/2008 **Condition:** acceptable
Analyzed By LSP 4/3/2008 **An?** OK **Apparent Smp Type** Wall System **Non-fibrous Solid**
Homogeneous Yes **# Layers** 1 **Pos Layer?** No **# Sub-Samples** 3
Non-Fibrous Components (in approx. decreasing order): powder, ,

Layers					Percents of Each Fiber					
#	Layer Type	%	Color	Friability	Fib 1	Fib 2	Fib 3	Fib 4	Fib 5	Fib 6
1	texture/joint compound	100	white	3	n.d.	-	-	-	-	-
Total %		100	Average %		n.d.	-	-	-	-	-

Fiber Identification: none

Fibers									Refractive Index Determinations				
#	Color	Mrph	Iso	Pleo	Bi	Elg	Ext	Oil	Col Par	Col Per	RI Par	RI Per	
1	none												
2													
3													
4													
5													
6													

Sample Analytical Note

Procedure: tweased apart using forceps. Procedure: dissolution of matrix using dilute HCl acid.

PLM Analysis Details

Job Number: 200802110 08-085/Kyrene De La Esperanza

Sample S-SAT-39A **Lab Number** 2008-02110- 88 **Sampled:** 3/6/2008 **Condition:** acceptable
Analyzed By LSP 4/4/2008 **An?** OK **Apparent Smp Type** Wall System **Non-fibrous Solid**
Homogeneous Yes **# Layers** 1 **Pos Layer?** No **# Sub-Samples** 3
Non-Fibrous Components (in approx. decreasing order): powder, ,

Layers					Percents of Each Fiber					
#	Layer Type	%	Color	Friability	Fib 1	Fib 2	Fib 3	Fib 4	Fib 5	Fib 6
1	texture/joint compound	100	white	3	n.d.	-	-	-	-	-
Total %		100	Average %		n.d.	-	-	-	-	-

Fiber Identification: none

Fibers									Refractive Index Determinations				
#	Color	Mrph	Iso	Pleo	Bi	Elg	Ext	Oil	Col Par	Col Per	RI Par	RI Per	
1	none												
2													
3													
4													
5													
6													

Sample Analytical Note
 Procedure: tweased apart using forceps. Procedure: dissolution of matrix using dilute HCl acid.

Sample S-SAT-39B **Lab Number** 2008-02110- 89 **Sampled:** 3/6/2008 **Condition:** acceptable
Analyzed By LSP 4/4/2008 **An?** OK **Apparent Smp Type** Wall System **Non-fibrous Solid**
Homogeneous Yes **# Layers** 1 **Pos Layer?** No **# Sub-Samples** 3
Non-Fibrous Components (in approx. decreasing order): powder, ,

Layers					Percents of Each Fiber					
#	Layer Type	%	Color	Friability	Fib 1	Fib 2	Fib 3	Fib 4	Fib 5	Fib 6
1	texture/joint compound	100	white	3	n.d.	-	-	-	-	-
Total %		100	Average %		n.d.	-	-	-	-	-

Fiber Identification: none

Fibers									Refractive Index Determinations				
#	Color	Mrph	Iso	Pleo	Bi	Elg	Ext	Oil	Col Par	Col Per	RI Par	RI Per	
1	none												
2													
3													
4													
5													
6													

Sample Analytical Note
 Procedure: tweased apart using forceps. Procedure: dissolution of matrix using dilute HCl acid.

Sample S-SAT-39C **Lab Number** 2008-02110- 90 **Sampled:** 3/6/2008 **Condition:** acceptable
Analyzed By LSP 4/4/2008 **An?** OK **Apparent Smp Type** Wall System **Non-fibrous Solid**
Homogeneous Yes **# Layers** 1 **Pos Layer?** No **# Sub-Samples** 3
Non-Fibrous Components (in approx. decreasing order): powder, ,

Layers					Percents of Each Fiber					
#	Layer Type	%	Color	Friability	Fib 1	Fib 2	Fib 3	Fib 4	Fib 5	Fib 6
1	texture/joint compound	100	white	3	n.d.	-	-	-	-	-
Total %		100	Average %		n.d.	-	-	-	-	-

Fiber Identification: none

Fibers									Refractive Index Determinations				
#	Color	Mrph	Iso	Pleo	Bi	Elg	Ext	Oil	Col Par	Col Per	RI Par	RI Per	
1	none												
2													
3													
4													
5													
6													

Sample Analytical Note
 Procedure: tweased apart using forceps. Procedure: dissolution of matrix using dilute HCl acid.

PLM Analysis Details

Job Number: 200802110

08-085/Kyrene De La Esperanza

Sample M-GWB-40A **Lab Number** 2008-02110- 91 **Sampled:** 3/6/2008 **Condition:** acceptable
Analyzed By LSP 4/4/2008 **An?** OK **Apparent Smp Type** Wall System **Fibrous Solid**
Homogeneous Yes **# Layers** 1 **Pos Layer?** No **# Sub-Samples** 3
Non-Fibrous Components (in approx. decreasing order): powder, ,

Layers					Percents of Each Fiber					
#	Layer Type	%	Color	Friability	Fib 1	Fib 2	Fib 3	Fib 4	Fib 5	Fib 6
1	drywall core	100	white	3	<=1%	<=1%	-	-	-	-
Total %		100	Average %		<=1%	<=1%	-	-	-	-
Fiber Identification:					glass fiber	cellulose fiber				

Fibers									Refractive Index Determinations				
#	Layer Type	Color	Mrph	Iso	Pleo	Bi	Elg	Ext	Oil	Col Par	Col Per	RI Par	RI Per
1	glass fiber	CL	D	Y									
2	cellulose fiber	W	F	N	N	H	+	U					
3													
4													
5													
6													

Sample Analytical Note
 Procedure: tweased apart using forceps.

Sample M-GWB-40B **Lab Number** 2008-02110- 92 **Sampled:** 3/6/2008 **Condition:** acceptable
Analyzed By LSP 4/4/2008 **An?** OK **Apparent Smp Type** Wall System **Fibrous Solid**
Homogeneous Yes **# Layers** 1 **Pos Layer?** No **# Sub-Samples** 3
Non-Fibrous Components (in approx. decreasing order): powder, ,

Layers					Percents of Each Fiber					
#	Layer Type	%	Color	Friability	Fib 1	Fib 2	Fib 3	Fib 4	Fib 5	Fib 6
1	drywall core	100	white	3	<=1%	<=1%	-	-	-	-
Total %		100	Average %		<=1%	<=1%	-	-	-	-
Fiber Identification:					glass fiber	cellulose fiber				

Fibers									Refractive Index Determinations				
#	Layer Type	Color	Mrph	Iso	Pleo	Bi	Elg	Ext	Oil	Col Par	Col Per	RI Par	RI Per
1	glass fiber	CL	D	Y									
2	cellulose fiber	W	F	N	N	H	+	U					
3													
4													
5													
6													

Sample Analytical Note
 Procedure: tweased apart using forceps.

Sample M-GWB-40C **Lab Number** 2008-02110- 93 **Sampled:** 3/6/2008 **Condition:** acceptable
Analyzed By LSP 4/4/2008 **An?** OK **Apparent Smp Type** Wall System **Fibrous Solid**
Homogeneous Yes **# Layers** 1 **Pos Layer?** No **# Sub-Samples** 3
Non-Fibrous Components (in approx. decreasing order): powder, ,

Layers					Percents of Each Fiber					
#	Layer Type	%	Color	Friability	Fib 1	Fib 2	Fib 3	Fib 4	Fib 5	Fib 6
1	drywall core	100	white	3	<=1%	<=1%	-	-	-	-
Total %		100	Average %		<=1%	<=1%	-	-	-	-
Fiber Identification:					glass fiber	cellulose fiber				

Fibers									Refractive Index Determinations				
#	Layer Type	Color	Mrph	Iso	Pleo	Bi	Elg	Ext	Oil	Col Par	Col Per	RI Par	RI Per
1	glass fiber	CL	D	Y									
2	cellulose fiber	W	F	N	N	H	+	U					
3													
4													
5													
6													

Sample Analytical Note
 Procedure: tweased apart using forceps.

PLM Analysis Details

Job Number: 200802110 08-085/Kyrene De La Esperanza

Sample S-JTC-41A **Lab Number** 2008-02110- 94 **Sampled:** 3/6/2008 **Condition:** acceptable
Analyzed By LSP 4/4/2008 **An?** OK **Apparent Smp Type** Wall System **Non-fibrous Solid**
Homogeneous Yes **# Layers** 1 **Pos Layer?** No **# Sub-Samples** 3
Non-Fibrous Components (in approx. decreasing order): powder, ,

Layers					Percents of Each Fiber					
#	Layer Type	%	Color	Friability	Fib 1	Fib 2	Fib 3	Fib 4	Fib 5	Fib 6
1	texture/joint compound	100	white	3	n.d.	-	-	-	-	-
Total %		100	Average %		n.d.	-	-	-	-	-
Fiber Identification: none										

Fibers									Refractive Index Determinations				
#	Color	Mrph	Iso	Pleo	Bi	Elg	Ext	Oil	Col Par	Col Per	RI Par	RI Per	
1	none												
2													
3													
4													
5													
6													

Sample Analytical Note
 Procedure: tweased apart using forceps. Procedure: dissolution of matrix using dilute HCl acid.

Sample S-JTC-41B **Lab Number** 2008-02110- 95 **Sampled:** 3/6/2008 **Condition:** acceptable
Analyzed By LSP 4/4/2008 **An?** OK **Apparent Smp Type** Wall System **Non-fibrous Solid**
Homogeneous Yes **# Layers** 1 **Pos Layer?** No **# Sub-Samples** 3
Non-Fibrous Components (in approx. decreasing order): powder, ,

Layers					Percents of Each Fiber					
#	Layer Type	%	Color	Friability	Fib 1	Fib 2	Fib 3	Fib 4	Fib 5	Fib 6
1	texture/joint compound	100	white	3	n.d.	-	-	-	-	-
Total %		100	Average %		n.d.	-	-	-	-	-
Fiber Identification: none										

Fibers									Refractive Index Determinations				
#	Color	Mrph	Iso	Pleo	Bi	Elg	Ext	Oil	Col Par	Col Per	RI Par	RI Per	
1	none												
2													
3													
4													
5													
6													

Sample Analytical Note
 Procedure: tweased apart using forceps. Procedure: dissolution of matrix using dilute HCl acid.

Sample S-JTC-41C **Lab Number** 2008-02110- 96 **Sampled:** 3/6/2008 **Condition:** acceptable
Analyzed By LSP 4/4/2008 **An?** OK **Apparent Smp Type** Wall System **Non-fibrous Solid**
Homogeneous Yes **# Layers** 1 **Pos Layer?** No **# Sub-Samples** 3
Non-Fibrous Components (in approx. decreasing order): powder, ,

Layers					Percents of Each Fiber					
#	Layer Type	%	Color	Friability	Fib 1	Fib 2	Fib 3	Fib 4	Fib 5	Fib 6
1	texture/joint compound	100	white	3	n.d.	-	-	-	-	-
Total %		100	Average %		n.d.	-	-	-	-	-
Fiber Identification: none										

Fibers									Refractive Index Determinations				
#	Color	Mrph	Iso	Pleo	Bi	Elg	Ext	Oil	Col Par	Col Per	RI Par	RI Per	
1	none												
2													
3													
4													
5													
6													

Sample Analytical Note
 Procedure: tweased apart using forceps. Procedure: dissolution of matrix using dilute HCl acid.

PLM Analysis Details

Job Number: 200802110 08-085/Kyrene De La Esperanza

Sample M-SAC-42A **Lab Number** 2008-02110- 97 **Sampled:** 3/6/2008 **Condition:** acceptable
Analyzed By LSP 4/4/2008 **An?** OK **Apparent Smp Type** Miscellaneous **Fibrous Solid**
Homogeneous Yes **# Layers** 1 **Pos Layer?** No **# Sub-Samples** 3
Non-Fibrous Components (in approx. decreasing order): polymer, filler,

Layers					Percents of Each Fiber					
#	Layer Type	%	Color	Friability	Fib 1	Fib 2	Fib 3	Fib 4	Fib 5	Fib 6
1	coating	100	Gray	1	2-5%	-	-	-	-	-
Total %		100	Average %		2-5%	-	-	-	-	-
Fiber Identification:					cellulose fiber					

Fibers									Refractive Index Determinations				
#	Layer Type	Color	Mrph	Iso	Pleo	Bi	Elg	Ext	Oil	Col Par	Col Per	RI Par	RI Per
1	cellulose fiber	W	F	N	N	H	+	U					
2													
3													
4													
5													
6													

Sample Analytical Note
 Procedure: tweased apart using forceps. Procedure: dissolution of matrix using solvent.

Sample M-SAC-42B **Lab Number** 2008-02110- 98 **Sampled:** 3/6/2008 **Condition:** acceptable
Analyzed By LSP 4/4/2008 **An?** OK **Apparent Smp Type** Miscellaneous **Fibrous Solid**
Homogeneous Yes **# Layers** 1 **Pos Layer?** No **# Sub-Samples** 3
Non-Fibrous Components (in approx. decreasing order): polymer, filler,

Layers					Percents of Each Fiber					
#	Layer Type	%	Color	Friability	Fib 1	Fib 2	Fib 3	Fib 4	Fib 5	Fib 6
1	coating	100	Gray	1	2-5%	-	-	-	-	-
Total %		100	Average %		2-5%	-	-	-	-	-
Fiber Identification:					cellulose fiber					

Fibers									Refractive Index Determinations				
#	Layer Type	Color	Mrph	Iso	Pleo	Bi	Elg	Ext	Oil	Col Par	Col Per	RI Par	RI Per
1	cellulose fiber	W	F	N	N	H	+	U					
2													
3													
4													
5													
6													

Sample Analytical Note
 Procedure: tweased apart using forceps. Procedure: dissolution of matrix using solvent.

Sample M-SAC-42C **Lab Number** 2008-02110- 99 **Sampled:** 3/6/2008 **Condition:** acceptable
Analyzed By LSP 4/4/2008 **An?** OK **Apparent Smp Type** Miscellaneous **Fibrous Solid**
Homogeneous Yes **# Layers** 1 **Pos Layer?** No **# Sub-Samples** 3
Non-Fibrous Components (in approx. decreasing order): polymer, filler,

Layers					Percents of Each Fiber					
#	Layer Type	%	Color	Friability	Fib 1	Fib 2	Fib 3	Fib 4	Fib 5	Fib 6
1	coating	100	Gray	1	2-5%	-	-	-	-	-
Total %		100	Average %		2-5%	-	-	-	-	-
Fiber Identification:					cellulose fiber					

Fibers									Refractive Index Determinations				
#	Layer Type	Color	Mrph	Iso	Pleo	Bi	Elg	Ext	Oil	Col Par	Col Per	RI Par	RI Per
1	cellulose fiber	W	F	N	N	H	+	U					
2													
3													
4													
5													
6													

Sample Analytical Note
 Procedure: tweased apart using forceps. Procedure: dissolution of matrix using solvent.

PLM Analysis Details

Job Number: 200802110

08-085/Kyrene De La Esperanza

Sample M-SLT-43A **Lab Number** 2008-02110- 100 **Sampled:** 3/6/2008 **Condition:** acceptable
Analyzed By LSP 4/4/2008 **An?** OK **Apparent Smp Type** Adhesive/caulk Sticky
Homogeneous No **# Layers** 2 **Pos Layer?** No **# Sub-Samples** 4
Non-Fibrous Components (in approx. decreasing order): filler, polymer,

Layers					Percents of Each Fiber					
#	Layer Type	%	Color	Friability	Fib 1	Fib 2	Fib 3	Fib 4	Fib 5	Fib 6
1	sealant	70	Black	1	n.d.	-	-	-	-	-
2	sealant	30	Yellow	1	>1-2%	-	-	-	-	-
Total %		100	Average %		<=1%	-	-	-	-	-
Fiber Identification:					cellulose fiber					

Fibers									Refractive Index Determinations				
#	Color	Mrph	Iso	Pleo	Bi	Elg	Ext	Oil	Col Par	Col Per	RI Par	RI Per	
1	cellulose fiber	W	F	N	N	H	+	U					
2													
3													
4													
5													
6													

Sample Analytical Note
 Procedure: tweased apart using forceps. Procedure: dissolution of matrix using solvent.

Sample M-SLT-43B **Lab Number** 2008-02110- 101 **Sampled:** 3/6/2008 **Condition:** acceptable
Analyzed By LSP 4/4/2008 **An?** OK **Apparent Smp Type** Adhesive/caulk Sticky
Homogeneous Yes **# Layers** 1 **Pos Layer?** No **# Sub-Samples** 3
Non-Fibrous Components (in approx. decreasing order): filler, polymer,

Layers					Percents of Each Fiber					
#	Layer Type	%	Color	Friability	Fib 1	Fib 2	Fib 3	Fib 4	Fib 5	Fib 6
1	sealant	100	Black	1	n.d.	-	-	-	-	-
Total %		100	Average %		n.d.	-	-	-	-	-
Fiber Identification:					none					

Fibers									Refractive Index Determinations				
#	Color	Mrph	Iso	Pleo	Bi	Elg	Ext	Oil	Col Par	Col Per	RI Par	RI Per	
1	none												
2													
3													
4													
5													
6													

Sample Analytical Note
 Procedure: tweased apart using forceps. Procedure: dissolution of matrix using solvent.

Sample M-SLT-43C **Lab Number** 2008-02110- 102 **Sampled:** 3/6/2008 **Condition:** acceptable
Analyzed By LSP 4/4/2008 **An?** OK **Apparent Smp Type** Adhesive/caulk Sticky
Homogeneous Yes **# Layers** 1 **Pos Layer?** No **# Sub-Samples** 3
Non-Fibrous Components (in approx. decreasing order): filler, polymer,

Layers					Percents of Each Fiber					
#	Layer Type	%	Color	Friability	Fib 1	Fib 2	Fib 3	Fib 4	Fib 5	Fib 6
1	sealant	100	Black	1	n.d.	-	-	-	-	-
Total %		100	Average %		n.d.	-	-	-	-	-
Fiber Identification:					none					

Fibers									Refractive Index Determinations				
#	Color	Mrph	Iso	Pleo	Bi	Elg	Ext	Oil	Col Par	Col Per	RI Par	RI Per	
1	none												
2													
3													
4													
5													
6													

Sample Analytical Note
 Procedure: tweased apart using forceps. Procedure: dissolution of matrix using solvent.

PLM Analysis Details

Job Number: 200802110 08-085/Kyrene De La Esperanza

Sample M-TWP-45A Lab Number 2008-02110- 103 Sampled: 3/6/2008 Condition: acceptable
 Analyzed By LSP 4/4/2008 An? OK Apparent Smp Type Acoustic Tile Fibrous Mat
 Homogeneous Yes # Layers 1 Pos Layer? No # Sub-Samples 3
 Non-Fibrous Components (in approx. decreasing order): polymer, binder,

Layers					Percents of Each Fiber					
#	Layer Type	%	Color	Friability	Fib 1	Fib 2	Fib 3	Fib 4	Fib 5	Fib 6
1	panel	100	Tan	3	90-100%	-	-	-	-	-
Total %		100	Average %		90-100%	-	-	-	-	-
Fiber Identification:					cellulose fiber					

Fibers									Refractive Index Determinations				
#	Color	Mrph	Iso	Pleo	Bi	Elg	Ext		Oil	Col Par	Col Per	RI Par	RI Per
1	W	F	N	N	H	+	U	cellulose fiber					
2													
3													
4													
5													
6													

Sample Analytical Note
 Procedure: teased apart using forceps. Procedure: dissolution of matrix using solvent.

Sample M-TWP-45B Lab Number 2008-02110- 104 Sampled: 3/6/2008 Condition: acceptable
 Analyzed By LSP 4/4/2008 An? OK Apparent Smp Type Acoustic Tile Fibrous Mat
 Homogeneous Yes # Layers 1 Pos Layer? No # Sub-Samples 3
 Non-Fibrous Components (in approx. decreasing order): polymer, binder,

Layers					Percents of Each Fiber					
#	Layer Type	%	Color	Friability	Fib 1	Fib 2	Fib 3	Fib 4	Fib 5	Fib 6
1	panel	100	Tan	3	90-100%	-	-	-	-	-
Total %		100	Average %		90-100%	-	-	-	-	-
Fiber Identification:					cellulose fiber					

Fibers									Refractive Index Determinations				
#	Color	Mrph	Iso	Pleo	Bi	Elg	Ext		Oil	Col Par	Col Per	RI Par	RI Per
1	W	F	N	N	H	+	U	cellulose fiber					
2													
3													
4													
5													
6													

Sample Analytical Note
 Procedure: teased apart using forceps. Procedure: dissolution of matrix using solvent.

Sample M-TWP-45C Lab Number 2008-02110- 105 Sampled: 3/6/2008 Condition: acceptable
 Analyzed By LSP 4/4/2008 An? OK Apparent Smp Type Acoustic Tile Fibrous Mat
 Homogeneous Yes # Layers 1 Pos Layer? No # Sub-Samples 3
 Non-Fibrous Components (in approx. decreasing order): polymer, binder,

Layers					Percents of Each Fiber					
#	Layer Type	%	Color	Friability	Fib 1	Fib 2	Fib 3	Fib 4	Fib 5	Fib 6
1	panel	100	Tan	3	90-100%	-	-	-	-	-
Total %		100	Average %		90-100%	-	-	-	-	-
Fiber Identification:					cellulose fiber					

Fibers									Refractive Index Determinations				
#	Color	Mrph	Iso	Pleo	Bi	Elg	Ext		Oil	Col Par	Col Per	RI Par	RI Per
1	W	F	N	N	H	+	U	cellulose fiber					
2													
3													
4													
5													
6													

Sample Analytical Note
 Procedure: teased apart using forceps. Procedure: dissolution of matrix using solvent.

PLM Analysis Details

Job Number: 200802110 08-085/Kyrene De La Esperanza

Sample M-VCT-46A **Lab Number** 2008-02110- 106 **Sampled:** 3/6/2008 **Condition:** acceptable
Analyzed By LSP 4/4/2008 **An?** OK **Apparent Smp Type** Flooring **Non-fibrous Solid**
Homogeneous Yes **# Layers** 1 **Pos Layer?** No **# Sub-Samples** 3
Non-Fibrous Components (in approx. decreasing order): filler, binder,

Layers					Percents of Each Fiber					
#	Layer Type	%	Color	Friability	Fib 1	Fib 2	Fib 3	Fib 4	Fib 5	Fib 6
1	floor tile	100	Blue	1	n.d.	-	-	-	-	-
Total %		100	Average %		n.d.	-	-	-	-	-

Fiber Identification: none

Fibers									Refractive Index Determinations				
#	Color	Mrph	Iso	Pleo	Bi	Elg	Ext	Oil	Col Par	Col Per	RI Par	RI Per	
1	none												
2													
3													
4													
5													
6													

Sample Analytical Note
 Procedure: tweased apart using forceps. Procedure: dissolution of matrix using solvent. Looks like a rubber baseboard molding.

Sample M-VCT-46B **Lab Number** 2008-02110- 107 **Sampled:** 3/6/2008 **Condition:** acceptable
Analyzed By LSP 4/4/2008 **An?** OK **Apparent Smp Type** Flooring **Non-fibrous Solid**
Homogeneous Yes **# Layers** 1 **Pos Layer?** No **# Sub-Samples** 3
Non-Fibrous Components (in approx. decreasing order): filler, binder,

Layers					Percents of Each Fiber					
#	Layer Type	%	Color	Friability	Fib 1	Fib 2	Fib 3	Fib 4	Fib 5	Fib 6
1	floor tile	100	Blue	1	n.d.	-	-	-	-	-
Total %		100	Average %		n.d.	-	-	-	-	-

Fiber Identification: none

Fibers									Refractive Index Determinations				
#	Color	Mrph	Iso	Pleo	Bi	Elg	Ext	Oil	Col Par	Col Per	RI Par	RI Per	
1	none												
2													
3													
4													
5													
6													

Sample Analytical Note
 Procedure: tweased apart using forceps. Procedure: dissolution of matrix using solvent. Looks like a rubber baseboard molding.

Sample M-VCT-46C **Lab Number** 2008-02110- 108 **Sampled:** 3/6/2008 **Condition:** acceptable
Analyzed By LSP 4/4/2008 **An?** OK **Apparent Smp Type** Flooring **Non-fibrous Solid**
Homogeneous Yes **# Layers** 1 **Pos Layer?** No **# Sub-Samples** 3
Non-Fibrous Components (in approx. decreasing order): filler, binder,

Layers					Percents of Each Fiber					
#	Layer Type	%	Color	Friability	Fib 1	Fib 2	Fib 3	Fib 4	Fib 5	Fib 6
1	floor tile	100	Blue	1	n.d.	-	-	-	-	-
Total %		100	Average %		n.d.	-	-	-	-	-

Fiber Identification: none

Fibers									Refractive Index Determinations				
#	Color	Mrph	Iso	Pleo	Bi	Elg	Ext	Oil	Col Par	Col Per	RI Par	RI Per	
1	none												
2													
3													
4													
5													
6													

Sample Analytical Note
 Procedure: tweased apart using forceps. Procedure: dissolution of matrix using solvent. Looks like a rubber baseboard molding.

PLM Analysis Details

Job Number: 200802110

08-085/Kyrene De La Esperanza

Sample M-MAS-47A **Lab Number** 2008-02110- 109 **Sampled:** 3/6/2008 **Condition:** acceptable
Analyzed By LSP 4/4/2008 **An?** OK **Apparent Smp Type** Adhesive/caulk Non-fibrous Solid
Homogeneous Yes **# Layers** 1 **Pos Layer?** No **# Sub-Samples** 3
Non-Fibrous Components (in approx. decreasing order): filler, polymer,

Layers					Percents of Each Fiber					
#	Layer Type	%	Color	Friability	Fib 1	Fib 2	Fib 3	Fib 4	Fib 5	Fib 6
1	mastic	100	Off-white	1	n.d.	-	-	-	-	-
Total %		100	Average %		n.d.	-	-	-	-	-
Fiber Identification:					none					

Fibers									Refractive Index Determinations				
#	Color	Mrph	Iso	Pleo	Bi	Elg	Ext	Oil	Col Par	Col Per	RI Par	RI Per	
1	none												
2													
3													
4													
5													
6													

Sample Analytical Note
 Procedure: tweased apart using forceps. Procedure: dissolution of matrix using solvent.

Sample M-MAS-47B **Lab Number** 2008-02110- 110 **Sampled:** 3/6/2008 **Condition:** acceptable
Analyzed By LSP 4/4/2008 **An?** OK **Apparent Smp Type** Adhesive/caulk Non-fibrous Solid
Homogeneous Yes **# Layers** 1 **Pos Layer?** No **# Sub-Samples** 3
Non-Fibrous Components (in approx. decreasing order): filler, polymer,

Layers					Percents of Each Fiber					
#	Layer Type	%	Color	Friability	Fib 1	Fib 2	Fib 3	Fib 4	Fib 5	Fib 6
1	mastic	100	Off-white	1	n.d.	-	-	-	-	-
Total %		100	Average %		n.d.	-	-	-	-	-
Fiber Identification:					none					

Fibers									Refractive Index Determinations				
#	Color	Mrph	Iso	Pleo	Bi	Elg	Ext	Oil	Col Par	Col Per	RI Par	RI Per	
1	none												
2													
3													
4													
5													
6													

Sample Analytical Note
 Procedure: tweased apart using forceps. Procedure: dissolution of matrix using solvent.

Sample M-MAS-47C **Lab Number** 2008-02110- 111 **Sampled:** 3/6/2008 **Condition:** acceptable
Analyzed By LSP 4/4/2008 **An?** OK **Apparent Smp Type** Adhesive/caulk Non-fibrous Solid
Homogeneous Yes **# Layers** 1 **Pos Layer?** No **# Sub-Samples** 3
Non-Fibrous Components (in approx. decreasing order): filler, polymer,

Layers					Percents of Each Fiber					
#	Layer Type	%	Color	Friability	Fib 1	Fib 2	Fib 3	Fib 4	Fib 5	Fib 6
1	mastic	100	Off-white	1	n.d.	-	-	-	-	-
Total %		100	Average %		n.d.	-	-	-	-	-
Fiber Identification:					none					

Fibers									Refractive Index Determinations				
#	Color	Mrph	Iso	Pleo	Bi	Elg	Ext	Oil	Col Par	Col Per	RI Par	RI Per	
1	none												
2													
3													
4													
5													
6													

Sample Analytical Note
 Procedure: tweased apart using forceps. Procedure: dissolution of matrix using solvent.

PLM Analysis Details

Job Number: 200802110 08-085/Kyrene De La Esperanza

Sample M-VCT-48A Lab Number 2008-02110- 112 Sampled: 3/6/2008 Condition: acceptable
 Analyzed By LSP 4/4/2008 An? OK Apparent Smp Type Flooring Non-fibrous Solid
 Homogeneous Yes # Layers 1 Pos Layer? No # Sub-Samples 3
 Non-Fibrous Components (in approx. decreasing order): filler, binder,

Layers					Percents of Each Fiber					
#	Layer Type	%	Color	Friability	Fib 1	Fib 2	Fib 3	Fib 4	Fib 5	Fib 6
1	floor tile	100	Pink	1	n.d.	-	-	-	-	-
Total %		100	Average %		n.d.	-	-	-	-	-
Fiber Identification:					none					

Fibers									Refractive Index Determinations				
#	Color	Mrph	Iso	Pleo	Bi	Elg	Ext	Oil	Col Par	Col Per	RI Par	RI Per	
1	none												
2													
3													
4													
5													
6													

Sample Analytical Note
 Procedure: tweased apart using forceps. Procedure: dissolution of matrix using solvent.

Sample M-VCT-48B Lab Number 2008-02110- 113 Sampled: 3/6/2008 Condition: acceptable
 Analyzed By LSP 4/4/2008 An? OK Apparent Smp Type Flooring Non-fibrous Solid
 Homogeneous Yes # Layers 1 Pos Layer? No # Sub-Samples 3
 Non-Fibrous Components (in approx. decreasing order): filler, binder,

Layers					Percents of Each Fiber					
#	Layer Type	%	Color	Friability	Fib 1	Fib 2	Fib 3	Fib 4	Fib 5	Fib 6
1	floor tile	100	Pink	1	n.d.	-	-	-	-	-
Total %		100	Average %		n.d.	-	-	-	-	-
Fiber Identification:					none					

Fibers									Refractive Index Determinations				
#	Color	Mrph	Iso	Pleo	Bi	Elg	Ext	Oil	Col Par	Col Per	RI Par	RI Per	
1	none												
2													
3													
4													
5													
6													

Sample Analytical Note
 Procedure: tweased apart using forceps. Procedure: dissolution of matrix using solvent.

Sample M-VCT-48C Lab Number 2008-02110- 114 Sampled: 3/6/2008 Condition: acceptable
 Analyzed By LSP 4/4/2008 An? OK Apparent Smp Type Flooring Non-fibrous Solid
 Homogeneous Yes # Layers 1 Pos Layer? No # Sub-Samples 3
 Non-Fibrous Components (in approx. decreasing order): filler, binder,

Layers					Percents of Each Fiber					
#	Layer Type	%	Color	Friability	Fib 1	Fib 2	Fib 3	Fib 4	Fib 5	Fib 6
1	floor tile	100	Pink	1	n.d.	-	-	-	-	-
Total %		100	Average %		n.d.	-	-	-	-	-
Fiber Identification:					none					

Fibers									Refractive Index Determinations				
#	Color	Mrph	Iso	Pleo	Bi	Elg	Ext	Oil	Col Par	Col Per	RI Par	RI Per	
1	none												
2													
3													
4													
5													
6													

Sample Analytical Note
 Procedure: tweased apart using forceps. Procedure: dissolution of matrix using solvent.

PLM Analysis Details

Job Number: 200802110 08-085/Kyrene De La Esperanza

Sample M-SLT-49A **Lab Number** 2008-02110- 115 **Sampled:** 3/6/2008 **Condition:** acceptable
Analyzed By LSP 4/4/2008 **An?** OK **Apparent Smp Type** Adhesive/caulk **Non-fibrous Solid**
Homogeneous Yes **# Layers** 1 **Pos Layer?** No **# Sub-Samples** 3
Non-Fibrous Components (in approx. decreasing order): filler, binder,

Layers					Percents of Each Fiber					
#	Layer Type	%	Color	Friability	Fib 1	Fib 2	Fib 3	Fib 4	Fib 5	Fib 6
1	caulk	100	white	1	n.d.	-	-	-	-	-
Total %		100	Average %		n.d.	-	-	-	-	-
Fiber Identification:					none					

Fibers									Refractive Index Determinations				
#	Color	Mrph	Iso	Pleo	Bi	Elg	Ext	Oil	Col Par	Col Per	RI Par	RI Per	
1	none												
2													
3													
4													
5													
6													

Sample Analytical Note
 Procedure: tweased apart using forceps. Procedure: dissolution of matrix using solvent:

Sample M-SLT-49B **Lab Number** 2008-02110- 116 **Sampled:** 3/6/2008 **Condition:** acceptable
Analyzed By LSP 4/4/2008 **An?** OK **Apparent Smp Type** Adhesive/caulk **Non-fibrous Solid**
Homogeneous Yes **# Layers** 1 **Pos Layer?** No **# Sub-Samples** 3
Non-Fibrous Components (in approx. decreasing order): filler, binder,

Layers					Percents of Each Fiber					
#	Layer Type	%	Color	Friability	Fib 1	Fib 2	Fib 3	Fib 4	Fib 5	Fib 6
1	caulk	100	white	1	n.d.	-	-	-	-	-
Total %		100	Average %		n.d.	-	-	-	-	-
Fiber Identification:					none					

Fibers									Refractive Index Determinations				
#	Color	Mrph	Iso	Pleo	Bi	Elg	Ext	Oil	Col Par	Col Per	RI Par	RI Per	
1	none												
2													
3													
4													
5													
6													

Sample Analytical Note
 Procedure: tweased apart using forceps. Procedure: dissolution of matrix using solvent.

Sample M-SLT-49C **Lab Number** 2008-02110- 117 **Sampled:** 3/6/2008 **Condition:** acceptable
Analyzed By LSP 4/4/2008 **An?** OK **Apparent Smp Type** Adhesive/caulk **Non-fibrous Solid**
Homogeneous Yes **# Layers** 1 **Pos Layer?** No **# Sub-Samples** 3
Non-Fibrous Components (in approx. decreasing order): filler, binder,

Layers					Percents of Each Fiber					
#	Layer Type	%	Color	Friability	Fib 1	Fib 2	Fib 3	Fib 4	Fib 5	Fib 6
1	caulk	100	white	1	n.d.	-	-	-	-	-
Total %		100	Average %		n.d.	-	-	-	-	-
Fiber Identification:					none					

Fibers									Refractive Index Determinations				
#	Color	Mrph	Iso	Pleo	Bi	Elg	Ext	Oil	Col Par	Col Per	RI Par	RI Per	
1	none												
2													
3													
4													
5													
6													

Sample Analytical Note
 Procedure: tweased apart using forceps. Procedure: dissolution of matrix using solvent.

PLM Analysis Details

Job Number: 200802110 08-085/Kyrene De La Esperanza

Sample M-DST-50A **Lab Number** 2008-02110- 118 **Sampled:** 3/6/2008 **Condition:** acceptable
Analyzed By LSP 4/4/2008 **An?** OK **Apparent Smp Type** TSI **Fibrous Mat**
Homogeneous Yes **# Layers** 1 **Pos Layer?** No **# Sub-Samples** 3
Non-Fibrous Components (in approx. decreasing order): polymer, filler,

Layers					Percents of Each Fiber					
#	Layer Type	%	Color	Friability	Fib 1	Fib 2	Fib 3	Fib 4	Fib 5	Fib 6
1	duct tape	100	White	3	20-30%	-	-	-	-	-
Total %		100	Average %		20-30%	-	-	-	-	-
Fiber Identification:					cellulose fiber					

Fibers									Refractive Index Determinations				
	Color	Mrph	Iso	Pleo	Bi	Elg	Ext		Oil	Col Par	Col Per	RI Par	RI Per
1	cellulose fiber	W	F	N	N	H	+	U					
2													
3													
4													
5													
6													

Sample Analytical Note
 Procedure: tweased apart using forceps. Procedure: dissolution of matrix using solvent.

Sample M-DST-50B **Lab Number** 2008-02110- 119 **Sampled:** 3/6/2008 **Condition:** acceptable
Analyzed By LSP 4/4/2008 **An?** OK **Apparent Smp Type** TSI **Fibrous Mat**
Homogeneous Yes **# Layers** 1 **Pos Layer?** No **# Sub-Samples** 3
Non-Fibrous Components (in approx. decreasing order): polymer, filler,

Layers					Percents of Each Fiber					
#	Layer Type	%	Color	Friability	Fib 1	Fib 2	Fib 3	Fib 4	Fib 5	Fib 6
1	duct tape	100	White	3	20-30%	-	-	-	-	-
Total %		100	Average %		20-30%	-	-	-	-	-
Fiber Identification:					cellulose fiber					

Fibers									Refractive Index Determinations				
	Color	Mrph	Iso	Pleo	Bi	Elg	Ext		Oil	Col Par	Col Per	RI Par	RI Per
1	cellulose fiber	W	F	N	N	H	+	U					
2													
3													
4													
5													
6													

Sample Analytical Note
 Procedure: tweased apart using forceps. Procedure: dissolution of matrix using solvent.

Sample M-DST-50C **Lab Number** 2008-02110- 120 **Sampled:** 3/6/2008 **Condition:** acceptable
Analyzed By LSP 4/4/2008 **An?** OK **Apparent Smp Type** TSI **Fibrous Mat**
Homogeneous Yes **# Layers** 1 **Pos Layer?** No **# Sub-Samples** 3
Non-Fibrous Components (in approx. decreasing order): polymer, filler,

Layers					Percents of Each Fiber					
#	Layer Type	%	Color	Friability	Fib 1	Fib 2	Fib 3	Fib 4	Fib 5	Fib 6
1	duct tape	100	White	3	20-30%	-	-	-	-	-
Total %		100	Average %		20-30%	-	-	-	-	-
Fiber Identification:					cellulose fiber					

Fibers									Refractive Index Determinations				
	Color	Mrph	Iso	Pleo	Bi	Elg	Ext		Oil	Col Par	Col Per	RI Par	RI Per
1	cellulose fiber	W	F	N	N	H	+	U					
2													
3													
4													
5													
6													

Sample Analytical Note
 Procedure: tweased apart using forceps. Procedure: dissolution of matrix using solvent.

PLM Analysis Details

Job Number: 200802110 08-085/Kyrene De La Esperanza

Sample M-VCT-60A **Lab Number** 2008-02110- 121 **Sampled:** 3/6/2008 **Condition:** acceptable
Analyzed By LSP 4/4/2008 **An?** OK **Apparent Smp Type** Flooring **Non-fibrous Solid**
Homogeneous Yes **# Layers** 1 **Pos Layer?** No **# Sub-Samples** 3
Non-Fibrous Components (in approx. decreasing order): filler, binder,

Layers					Percents of Each Fiber					
#	Layer Type	%	Color	Friability	Fib 1	Fib 2	Fib 3	Fib 4	Fib 5	Fib 6
1	floor tile	100	Orange	1	n.d.	-	-	-	-	-
Total %		100	Average %		n.d.	-	-	-	-	-
Fiber Identification:					none					

Fibers									Refractive Index Determinations				
#	Color	Mrph	Iso	Pleo	Bi	Elg	Ext	Oil	Col Par	Col Per	RI Par	RI Per	
1	none												
2													
3													
4													
5													
6													

Sample Analytical Note
 Procedure: tweased apart using forceps. Procedure: dissolution of matrix using solvent.

Sample M-VCT-60B **Lab Number** 2008-02110- 122 **Sampled:** 3/6/2008 **Condition:** acceptable
Analyzed By LSP 4/4/2008 **An?** OK **Apparent Smp Type** Flooring **Non-fibrous Solid**
Homogeneous Yes **# Layers** 1 **Pos Layer?** No **# Sub-Samples** 3
Non-Fibrous Components (in approx. decreasing order): filler, binder,

Layers					Percents of Each Fiber					
#	Layer Type	%	Color	Friability	Fib 1	Fib 2	Fib 3	Fib 4	Fib 5	Fib 6
1	floor tile	100	Orange	1	n.d.	-	-	-	-	-
Total %		100	Average %		n.d.	-	-	-	-	-
Fiber Identification:					none					

Fibers									Refractive Index Determinations				
#	Color	Mrph	Iso	Pleo	Bi	Elg	Ext	Oil	Col Par	Col Per	RI Par	RI Per	
1	none												
2													
3													
4													
5													
6													

Sample Analytical Note
 Procedure: tweased apart using forceps. Procedure: dissolution of matrix using solvent.

Sample M-VCT-60C **Lab Number** 2008-02110- 123 **Sampled:** 3/6/2008 **Condition:** acceptable
Analyzed By LSP 4/4/2008 **An?** OK **Apparent Smp Type** Flooring **Non-fibrous Solid**
Homogeneous Yes **# Layers** 1 **Pos Layer?** No **# Sub-Samples** 3
Non-Fibrous Components (in approx. decreasing order): filler, binder,

Layers					Percents of Each Fiber					
#	Layer Type	%	Color	Friability	Fib 1	Fib 2	Fib 3	Fib 4	Fib 5	Fib 6
1	floor tile	100	Orange	1	n.d.	-	-	-	-	-
Total %		100	Average %		n.d.	-	-	-	-	-
Fiber Identification:					none					

Fibers									Refractive Index Determinations				
#	Color	Mrph	Iso	Pleo	Bi	Elg	Ext	Oil	Col Par	Col Per	RI Par	RI Per	
1	none												
2													
3													
4													
5													
6													

Sample Analytical Note
 Procedure: tweased apart using forceps. Procedure: dissolution of matrix using solvent.

PLM Analysis Details

Job Number: 200802110 08-085/Kyrene De La Esperanza

Sample M-VCT-61A **Lab Number** 2008-02110- 124 **Sampled:** 3/6/2008 **Condition:** acceptable
Analyzed By LSP 4/4/2008 **An?** OK **Apparent Smp Type** Flooring **Non-fibrous Solid**
Homogeneous Yes **# Layers** 1 **Pos Layer?** No **# Sub-Samples** 3
Non-Fibrous Components (in approx. decreasing order): filler, binder,

Layers					Percents of Each Fiber					
#	Layer Type	%	Color	Friability	Fib 1	Fib 2	Fib 3	Fib 4	Fib 5	Fib 6
1	floor tile	100	Blue	1	n.d.	-	-	-	-	-
Total %		100	Average %		n.d.	-	-	-	-	-
Fiber Identification:					none					

Fibers									Refractive Index Determinations				
#	Color	Mrph	Iso	Pleo	Bi	Elg	Ext	Oil	Col Par	Col Per	RI Par	RI Per	
1	none												
2													
3													
4													
5													
6													

Sample Analytical Note
 Procedure: tweased apart using forceps. Procedure: dissolution of matrix using solvent.

Sample M-VCT-61B **Lab Number** 2008-02110- 125 **Sampled:** 3/6/2008 **Condition:** acceptable
Analyzed By LSP 4/4/2008 **An?** OK **Apparent Smp Type** Flooring **Non-fibrous Solid**
Homogeneous Yes **# Layers** 1 **Pos Layer?** No **# Sub-Samples** 3
Non-Fibrous Components (in approx. decreasing order): filler, binder,

Layers					Percents of Each Fiber					
#	Layer Type	%	Color	Friability	Fib 1	Fib 2	Fib 3	Fib 4	Fib 5	Fib 6
1	floor tile	100	Blue	1	n.d.	-	-	-	-	-
Total %		100	Average %		n.d.	-	-	-	-	-
Fiber Identification:					none					

Fibers									Refractive Index Determinations				
#	Color	Mrph	Iso	Pleo	Bi	Elg	Ext	Oil	Col Par	Col Per	RI Par	RI Per	
1	none												
2													
3													
4													
5													
6													

Sample Analytical Note
 Procedure: tweased apart using forceps. Procedure: dissolution of matrix using solvent.

Sample M-VCT-61C **Lab Number** 2008-02110- 126 **Sampled:** 3/6/2008 **Condition:** acceptable
Analyzed By LSP 4/4/2008 **An?** OK **Apparent Smp Type** Flooring **Non-fibrous Solid**
Homogeneous Yes **# Layers** 1 **Pos Layer?** No **# Sub-Samples** 3
Non-Fibrous Components (in approx. decreasing order): filler, binder,

Layers					Percents of Each Fiber					
#	Layer Type	%	Color	Friability	Fib 1	Fib 2	Fib 3	Fib 4	Fib 5	Fib 6
1	floor tile	100	Blue	1	n.d.	-	-	-	-	-
Total %		100	Average %		n.d.	-	-	-	-	-
Fiber Identification:					none					

Fibers									Refractive Index Determinations				
#	Color	Mrph	Iso	Pleo	Bi	Elg	Ext	Oil	Col Par	Col Per	RI Par	RI Per	
1	none												
2													
3													
4													
5													
6													

Sample Analytical Note
 Procedure: tweased apart using forceps. Procedure: dissolution of matrix using solvent.

PLM Analysis Details

Job Number: 200802110 08-085/Kyrene De La Esperanza

Sample M-VCT-62A **Lab Number** 2008-02110- 127 **Sampled:** 3/6/2008 **Condition:** acceptable
Analyzed By LSP 4/4/2008 **An?** OK **Apparent Smp Type** Flooring **Non-fibrous Solid**
Homogeneous Yes **# Layers** 1 **Pos Layer?** No **# Sub-Samples** 3
Non-Fibrous Components (in approx. decreasing order): filler, binder,

Layers					Percents of Each Fiber					
#	Layer Type	%	Color	Friability	Fib 1	Fib 2	Fib 3	Fib 4	Fib 5	Fib 6
1	floor tile	100	Various	1	n.d.	-	-	-	-	-
Total %		100	Average %		n.d.	-	-	-	-	-
Fiber Identification:					none					

Fibers									Refractive Index Determinations				
#	Color	Mrph	Iso	Pleo	Bi	Elg	Ext	Oil	Col Par	Col Per	RI Par	RI Per	
1	none												
2													
3													
4													
5													
6													

Sample Analytical Note
 Procedure: tweased apart using forceps. Procedure: dissolution of matrix using solvent. Gray and buff colors but identical structure.

Sample M-VCT-62B **Lab Number** 2008-02110- 128 **Sampled:** 3/6/2008 **Condition:** acceptable
Analyzed By LSP 4/4/2008 **An?** OK **Apparent Smp Type** Flooring **Non-fibrous Solid**
Homogeneous Yes **# Layers** 1 **Pos Layer?** No **# Sub-Samples** 3
Non-Fibrous Components (in approx. decreasing order): filler, binder,

Layers					Percents of Each Fiber					
#	Layer Type	%	Color	Friability	Fib 1	Fib 2	Fib 3	Fib 4	Fib 5	Fib 6
1	floor tile	100	Various	1	n.d.	-	-	-	-	-
Total %		100	Average %		n.d.	-	-	-	-	-
Fiber Identification:					none					

Fibers									Refractive Index Determinations				
#	Color	Mrph	Iso	Pleo	Bi	Elg	Ext	Oil	Col Par	Col Per	RI Par	RI Per	
1	none												
2													
3													
4													
5													
6													

Sample Analytical Note
 Procedure: tweased apart using forceps. Procedure: dissolution of matrix using solvent. Gray and buff colors but identical structure.

Sample M-VCT-62C **Lab Number** 2008-02110- 129 **Sampled:** 3/6/2008 **Condition:** acceptable
Analyzed By LSP 4/4/2008 **An?** OK **Apparent Smp Type** Flooring **Non-fibrous Solid**
Homogeneous Yes **# Layers** 1 **Pos Layer?** No **# Sub-Samples** 3
Non-Fibrous Components (in approx. decreasing order): filler, binder,

Layers					Percents of Each Fiber					
#	Layer Type	%	Color	Friability	Fib 1	Fib 2	Fib 3	Fib 4	Fib 5	Fib 6
1	floor tile	100	Various	1	n.d.	-	-	-	-	-
Total %		100	Average %		n.d.	-	-	-	-	-
Fiber Identification:					none					

Fibers									Refractive Index Determinations				
#	Color	Mrph	Iso	Pleo	Bi	Elg	Ext	Oil	Col Par	Col Per	RI Par	RI Per	
1	none												
2													
3													
4													
5													
6													

Sample Analytical Note
 Procedure: tweased apart using forceps. Procedure: dissolution of matrix using solvent. Gray and buff colors but identical structure.

PLM Analysis Details

Job Number: 200802110 08-085/Kyrene De La Esperanza

Sample M-VCT-63A **Lab Number** 2008-02110- 130 **Sampled:** 3/6/2008 **Condition:** acceptable
Analyzed By LSP 4/4/2008 **An?** OK **Apparent Smp Type** Flooring **Non-fibrous Solid**
Homogeneous Yes **# Layers** 1 **Pos Layer?** No **# Sub-Samples** 3
Non-Fibrous Components (in approx. decreasing order): filler, binder,

Layers					Percents of Each Fiber					
#	Layer Type	%	Color	Friability	Fib 1	Fib 2	Fib 3	Fib 4	Fib 5	Fib 6
1	floor tile	100	Various	1	n.d.	-	-	-	-	-
Total %		100	Average %		n.d.	-	-	-	-	-
Fiber Identification:					none					

Fibers									Refractive Index Determinations				
#	Color	Mrph	Iso	Pleo	Bi	Elg	Ext	Oil	Col Par	Col Per	RI Par	RI Per	
1	none												
2													
3													
4													
5													
6													

Sample Analytical Note
 Procedure: tweased apart using forceps. Procedure: dissolution of matrix using solvent. Yellow and buff colors but identical structure.

Sample M-VCT-63B **Lab Number** 2008-02110- 131 **Sampled:** 3/6/2008 **Condition:** acceptable
Analyzed By LSP 4/4/2008 **An?** OK **Apparent Smp Type** Flooring **Non-fibrous Solid**
Homogeneous Yes **# Layers** 1 **Pos Layer?** No **# Sub-Samples** 3
Non-Fibrous Components (in approx. decreasing order): filler, binder,

Layers					Percents of Each Fiber					
#	Layer Type	%	Color	Friability	Fib 1	Fib 2	Fib 3	Fib 4	Fib 5	Fib 6
1	floor tile	100	Various	1	n.d.	-	-	-	-	-
Total %		100	Average %		n.d.	-	-	-	-	-
Fiber Identification:					none					

Fibers									Refractive Index Determinations				
#	Color	Mrph	Iso	Pleo	Bi	Elg	Ext	Oil	Col Par	Col Per	RI Par	RI Per	
1	none												
2													
3													
4													
5													
6													

Sample Analytical Note
 Procedure: tweased apart using forceps. Procedure: dissolution of matrix using solvent. Yellow and buff colors but identical structure.

Sample M-VCT-63C **Lab Number** 2008-02110- 132 **Sampled:** 3/6/2008 **Condition:** acceptable
Analyzed By LSP 4/4/2008 **An?** OK **Apparent Smp Type** Flooring **Non-fibrous Solid**
Homogeneous Yes **# Layers** 1 **Pos Layer?** No **# Sub-Samples** 3
Non-Fibrous Components (in approx. decreasing order): filler, binder,

Layers					Percents of Each Fiber					
#	Layer Type	%	Color	Friability	Fib 1	Fib 2	Fib 3	Fib 4	Fib 5	Fib 6
1	floor tile	100	Various	1	n.d.	-	-	-	-	-
Total %		100	Average %		n.d.	-	-	-	-	-
Fiber Identification:					none					

Fibers									Refractive Index Determinations				
#	Color	Mrph	Iso	Pleo	Bi	Elg	Ext	Oil	Col Par	Col Per	RI Par	RI Per	
1	none												
2													
3													
4													
5													
6													

Sample Analytical Note
 Procedure: tweased apart using forceps. Procedure: dissolution of matrix using solvent. Yellow and buff colors but identical structure.

PLM Analysis Details

Job Number: 200802110

08-085/Kyrene De La Esperanza

Sample M-VCT-64A **Lab Number** 2008-02110- 133 **Sampled:** 3/6/2008 **Condition:** acceptable
Analyzed By LSP 4/4/2008 **An?** OK **Apparent Smp Type** Flooring Non-fibrous Solid
Homogeneous Yes **# Layers** 1 **Pos Layer?** No **# Sub-Samples** 3
Non-Fibrous Components (in approx. decreasing order): filler, binder,

Layers					Percents of Each Fiber					
#	Layer Type	%	Color	Friability	Fib 1	Fib 2	Fib 3	Fib 4	Fib 5	Fib 6
1	floor tile	100	Various	1	n.d.	-	-	-	-	-
Total %		100	Average %		n.d.	-	-	-	-	-
Fiber Identification:					none					

Fibers									Refractive Index Determinations				
#	Color	Mrph	Iso	Pleo	Bi	Elg	Ext	Oil	Col Par	Col Per	RI Par	RI Per	
1	none												
2													
3													
4													
5													
6													

Sample Analytical Note
 Procedure: tweased apart using forceps. Procedure: dissolution of matrix using solvent. Green and buff colors but identical structure.

Sample M-VCT-64B **Lab Number** 2008-02110- 134 **Sampled:** 3/6/2008 **Condition:** acceptable
Analyzed By LSP 4/4/2008 **An?** OK **Apparent Smp Type** Flooring Non-fibrous Solid
Homogeneous Yes **# Layers** 1 **Pos Layer?** No **# Sub-Samples** 3
Non-Fibrous Components (in approx. decreasing order): filler, binder,

Layers					Percents of Each Fiber					
#	Layer Type	%	Color	Friability	Fib 1	Fib 2	Fib 3	Fib 4	Fib 5	Fib 6
1	floor tile	100	Various	1	n.d.	-	-	-	-	-
Total %		100	Average %		n.d.	-	-	-	-	-
Fiber Identification:					none					

Fibers									Refractive Index Determinations				
#	Color	Mrph	Iso	Pleo	Bi	Elg	Ext	Oil	Col Par	Col Per	RI Par	RI Per	
1	none												
2													
3													
4													
5													
6													

Sample Analytical Note
 Procedure: tweased apart using forceps. Procedure: dissolution of matrix using solvent. Green and buff colors but identical structure.

Sample M-VCT-64C **Lab Number** 2008-02110- 135 **Sampled:** 3/6/2008 **Condition:** acceptable
Analyzed By LSP 4/4/2008 **An?** OK **Apparent Smp Type** Flooring Non-fibrous Solid
Homogeneous Yes **# Layers** 1 **Pos Layer?** No **# Sub-Samples** 3
Non-Fibrous Components (in approx. decreasing order): filler, binder,

Layers					Percents of Each Fiber					
#	Layer Type	%	Color	Friability	Fib 1	Fib 2	Fib 3	Fib 4	Fib 5	Fib 6
1	floor tile	100	Various	1	n.d.	-	-	-	-	-
Total %		100	Average %		n.d.	-	-	-	-	-
Fiber Identification:					none					

Fibers									Refractive Index Determinations				
#	Color	Mrph	Iso	Pleo	Bi	Elg	Ext	Oil	Col Par	Col Per	RI Par	RI Per	
1	none												
2													
3													
4													
5													
6													

Sample Analytical Note
 Procedure: tweased apart using forceps. Procedure: dissolution of matrix using solvent. Green and buff colors but identical structure.

PLM Analysis Details

Job Number: 200802110

08-085/Kyrene De La Esperanza

Sample M-APL-65A **Lab Number** 2008-02110- 136 **Sampled:** 3/6/2008 **Condition:** acceptable
Analyzed By LSP 4/4/2008 **An?** OK **Apparent Smp Type** Acoustic Tile **Fibrous Solid**
Homogeneous Yes **# Layers** 1 **Pos Layer?** No **# Sub-Samples** 3
Non-Fibrous Components (in approx. decreasing order): powder, ,

Layers					Percents of Each Fiber					
#	Layer Type	%	Color	Friability	Fib 1	Fib 2	Fib 3	Fib 4	Fib 5	Fib 6
1	panel	100	White	1	<=1%	<=1%	-	-	-	-
Total %		100	Average %		<=1%	<=1%	-	-	-	-
Fiber Identification:					cellulose	glass fiber				

Fibers										Refractive Index Determinations				
	Color	Mrph	Iso	Pleo	Bi	Elg	Ext	Oil	Col Par	Col Per	RI Par	RI Per		
1	cellulose	W	F	N	N	H	+	U						
2	glass fiber	CL	D	Y										
3														
4														
5														
6														

Sample Analytical Note
 Procedure: tweased apart using forceps. Very similar to wallboard.

Sample M-APL-65B **Lab Number** 2008-02110- 137 **Sampled:** 3/6/2008 **Condition:** acceptable
Analyzed By LSP 4/4/2008 **An?** OK **Apparent Smp Type** Acoustic Tile **Fibrous Solid**
Homogeneous Yes **# Layers** 1 **Pos Layer?** No **# Sub-Samples** 3
Non-Fibrous Components (in approx. decreasing order): powder, ,

Layers					Percents of Each Fiber					
#	Layer Type	%	Color	Friability	Fib 1	Fib 2	Fib 3	Fib 4	Fib 5	Fib 6
1	panel	100	White	1	<=1%	<=1%	-	-	-	-
Total %		100	Average %		<=1%	<=1%	-	-	-	-
Fiber Identification:					cellulose	glass fiber				

Fibers										Refractive Index Determinations				
	Color	Mrph	Iso	Pleo	Bi	Elg	Ext	Oil	Col Par	Col Per	RI Par	RI Per		
1	cellulose	W	F	N	N	H	+	U						
2	glass fiber	CL	D	Y										
3														
4														
5														
6														

Sample Analytical Note
 Procedure: tweased apart using forceps. Very similar to wallboard.

Sample M-APL-65C **Lab Number** 2008-02110- 138 **Sampled:** 3/6/2008 **Condition:** acceptable
Analyzed By LSP 4/4/2008 **An?** OK **Apparent Smp Type** Acoustic Tile **Fibrous Solid**
Homogeneous Yes **# Layers** 1 **Pos Layer?** No **# Sub-Samples** 3
Non-Fibrous Components (in approx. decreasing order): powder, ,

Layers					Percents of Each Fiber					
#	Layer Type	%	Color	Friability	Fib 1	Fib 2	Fib 3	Fib 4	Fib 5	Fib 6
1	panel	100	White	1	<=1%	<=1%	-	-	-	-
Total %		100	Average %		<=1%	<=1%	-	-	-	-
Fiber Identification:					cellulose	glass fiber				

Fibers										Refractive Index Determinations				
	Color	Mrph	Iso	Pleo	Bi	Elg	Ext	Oil	Col Par	Col Per	RI Par	RI Per		
1	cellulose	W	F	N	N	H	+	U						
2	glass fiber	CL	D	Y										
3														
4														
5														
6														

Sample Analytical Note
 Procedure: tweased apart using forceps. Very similar to wallboard.

Fr=Friability: 1=very non-friable; 2= non-friable; 3=friable; 4=highly friable
 Colors: B=black; BL=blue; BR=brown; CL=clear; G=Green; GY=gray; OR=orange; OW=off-white; PN=pink; PU=purple; R=red; TN=tan; W=white; Y=yellow; V=various
 Fiber Morphology: A=fine fibers/bundles, white, sinewy, flexible; B=fine fibers/bundles, w-br, straight, broomed ends; C=fine fibers/bundles, blue, straight, broomed ends;
 D=fine to coarse fibers, CL-B, brittle; E=coarse fibers, CL or dyed, striated; F=coarse fibers or splinters, W-BR, ribbon-like; G=lath-like or shards, low aspect ratio, may taper
 Iso=isotropism - may be yes or no; Pleo=pleochroism - may be yes or no; Bi=birefringence - may be None, Low, Medium or High
 Elg=sign of elongation - may be +, - or B (both); Ext=extinction - may be Parallel, Oblique, None or Undulating; Oil=medium used to for dispersion staining
 Col Par=dispersion staining colors parallel to the fiber (fiber/halo): b/w=black/white; dg/py=dark gray/pale yellow; vg/y=violet gray/yellow; db/ly=dark blue/lemon yellow; vb/g= vivid blue/gold; sb/o=sky blue/orange; pb/r=pale blue/red; gb/dr=gray blue/dark red; w/b=white/black. Col Perp=same only perpendicular to fiber.
 RI Par=refractive index parallel to fiber; RI Perp=refractive index perpendicular to fiber

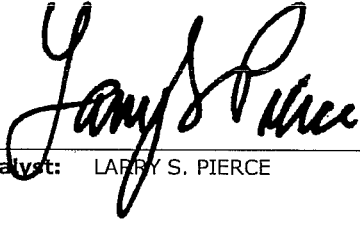

Analyst: LARRY S. PIERCE

Printed: 04-Apr-08

Original Print Date: 04-Apr-08



Larry S. Pierce, Approved Accreditation Signatory



15974 N. 77th Street
 Scottsdale, AZ 85260
 (602) 277-7877
 (602) 277-8288 fax

chain of custody

12

Date: 3/10/08
 Project No: 08088
 Initials: MICHAEL RICHTER
 Page: 1 of 1

Job: KURENE DE LA ESPERANZA
 Client: KSD
 Address: 14841 S. 41ST PLACE

Test: PLM 15-30
 Rush: Normal: Extended:
 Stop at 1st Positive: WNO
 Read all samples:
 Call with results:
 Fax results:

71/72 PORTABLES

MATERIAL CODE	MATERIAL DESCRIPTION	MATERIAL SAMPLE NO.		LAYERS**
M:APL:09	ACOUSTICAL CEILING PANEL	A-C	PA	S

**Sample Layers - M-MULTIPLE, S-SINGLE

RELINQUISHED BY:	DATE:	RECEIVED BY:	DATE:
<u>[Signature]</u>	<u>3/10/08</u>	<u>H. Townsend</u>	<u>3.6.08</u>

Polarized Light Microscope (PLM) Analysis for Asbestos

JobNumber: 200802111

Client:

FM GROUP INC

15974 N 77TH ST

SCOTTSDALE, AZ

85260-0000

Office Phone:

(602) 277-7877

FAX:

(602) 277-8288

Samples: 3 PLM **Rec:** 3/6/2008 **Method:** EPA 600/R-93/116

PLM analysis for asbestos in bulk smp

Client Job: 08-085/Kyrene De La Esperanza

PO Number: 08-085

Report Date: 3/12/2008

Date Analyzed: 3/12/2008

Routing Number: Michael Richter

Method and Analysis Information: Fiberquant Internal SOP: PLMn

Each bulk sample is first dissected under a 7-30x magnification stereo-microscope. This examination is used to determine the general type of sample, how many and what type of layers it has, and initial estimates of fiber types and quantities. Second, liquid media mounts are made of each layer - such mounts may be of selected fibers (used solely for identification purposes) or may be representative of the layer as a whole (used for quantitation purposes). The mounts may be made in a synthetic Canadian balsam, one of several solvents, or in refractive index oils (media of known refractive index). Generally, a variety of different mounts are made: some optimized for fiber visibility, some optimized for fiber identification, and some optimized for fiber quantitation. The mounted slides are then examined at 50-400x magnification on a Nikon Labphot-pol microscope. Optical characteristics are used to identify each observed fiber type; the optical data are contained for each sample on its detail analysis sheet, attached.

Current EPA, NESHAP and OSHA regulations designate a result of $\leq 1\%$ asbestos as "negative" and $> 1\%$ asbestos as "positive". Samples containing layers that have been determined to be "positive" may have to be handled differently during a renovation or demolition than samples whose layers have been determined to be "negative."

The method of fiber analysis and identification is the EPA Method 600/R-93/116. The method of fiber quantitation is an estimation technique in which the analysts quantitation is routinely calibrated by reference quantitation standards, and which has been shown to be equivalent in precision and accuracy to point counting. Friability is estimated for the purposes of deciding when to point count. Friabilities determined in the field take precedence over those determined in the laboratory. Those sample layers which are friable and estimated by the analyst to contain $\leq 1\%$ asbestos are point counted using 400 points. Such point counting is required by NESHAP (National Emission Standards for Hazardous Air Pollutants, Nov. 1990) in order to rely on analytical results that are $\leq 1\%$. The coefficient of variation for the estimation quantitation technique is 100% in the range 0-5%. This means that PLM analysis is not capable of conclusively determining whether a layer containing close to 1% asbestos is actually "positive" or "negative". For this reason, Fiberquant refers to results where asbestos was detected but $\leq 1\%$ as "borderline negative", and results where asbestos was $> 1\%$ but $\leq 2\%$ as "borderline positive" to indicate the uncertainty in assigning a "positive" or "negative" label. In the sample summary, "ND" means that no asbestos was detected during the analysis. A "Tr" or "Trace" of asbestos reported is defined for our purposes as the detection of several asbestos fibers during the analysis; this level would be right at the limit of detection for the method. Trace is only reported on the analysis detail - in the summary a trace would be reported as $\leq 1\%$. The limit of detection (the smallest % of asbestos that can be detected) varies greatly depending on the matrix in which the asbestos is found. As little as 0.001% asbestos can be detected in favorable samples, while detection in unfavorable samples may approach the detection limit of 1% stated in the method. During the analysis, the analyst, for Fiberquant identification purposes only, determines the "apparent sample type" and "apparent layer types." It must be emphasized that these types are only what is apparent. Often, different materials appear similar or identical after sampling, so the analyst may assign a type other than what was sampled.

Floor tiles present a special problem for PLM asbestos analysis. Floor tile can contain chrysotile fibers so thin that they cannot be resolved by optical methods. In such a case, we may observe a percentage of asbestos which is lower than the actual percentage, or not observe asbestos at all when some is present. For this reason, floor tiles reported as negative should be confirmed to be negative using transmission electron microscope (TEM) analysis. Likewise, vermiculite insulation materials containing traces of asbestiform asbestos present a problem for routine PLM analysis - the amphiboles are sometimes present in trace amounts inhomogeneously distributed. We recommend a hydro-separation technique for such samples.

Vermiculite-containing samples may contain trace amounts of asbestiform amphibole that may or may not be detected during routine PLM analysis. For this reason, loose vermiculite samples reported as negative should be confirmed to contain no amphibole using hydroseparation techniques.

The samples were analyzed under the following ongoing quality assurance program: Blank samples are routinely analyzed to maintain contamination-free materials. Each analyst has at least a bachelor's degree in physical science, and has also completed extensive training specific to asbestos analysis for 1-3 months before being allowed to analyze client samples. Qualitative reference samples are routinely analyzed to assure that analysts can identify asbestos and asbestos-look-alike fibers. Quantitative reference samples are routinely analyzed to calibrate and characterize the estimation procedure. Microscope alignment is checked each day. Refractive index oils are calibrated at least quarterly. At least 10% of client samples are re-analyzed from scratch by a different analyst than the original, and any discrepancies are resolved for the sample and similar sample types before the results are reported. All quality checks performed for these samples were in control except as detailed in the "Analytical Notes" below. All analysts participate in interlab round robins and proficiency testing to assure competence. Fiberquant is accredited by NVLAP (#101031) for the analysis of bulk samples for asbestos using PLM. Accreditation does not imply endorsement by the EPA, any other United States governmental agency or any private agency or association. Each lab analysis refers only to the sample tested, and may not, due to the sampling process, be

representative of the material sampled. This report may not be reproduced except in full, without the approval of Fiberquant Analytical Services. Some results may have been calculated using client supplied data, such as volume or area sampled, for which Fiberquant assumes no liability for accuracy.

Job Analysis Notes:

Single layer sample and "Analyze Until Positive Found" criteria were followed where requested by the client on the chain of custody.

PLM Analysis Summary:

Job Number: 200802111 08-085/Kyrene De La Esperanza

Sample Number		Lab Number	Apparent Sample Type *	Positive Layer Yes or No
Layer	Color	Apparent Layer Type *	Asbestos Results	
Sample #	M-APL-09A	2008-02111- 1	Acoustic Tile	Positive Layer? No
Layer # 1	Off-white	acoustical tile	<i>no asbestos detected</i>	
Sample #	M-APL-09B	2008-02111- 2	Acoustic Tile	Positive Layer? No
Layer # 1	Off-white	acoustical tile	<i>no asbestos detected</i>	
Sample #	M-APL-09C	2008-02111- 3	Acoustic Tile	Positive Layer? No
Layer # 1	Off-white	acoustical tile	<i>no asbestos detected</i>	

* Apparent Sample Types and Apparent Layer Types are as they appeared to the analyst. Since many types of materials appear similar after sampling damage, the apparent type of material may not be the actual type of material.

Sample M-APL-09A **Lab Number** 2008-02111- 1 **Sampled:** 3/6/2008 **Condition:** acceptable
Analyzed By DJF 3/12/2008 **An?** OK **Apparent Smp Type** Acoustic Tile **Fibrous Solid**
Homogeneous Yes **# Layers** 1 **Pos Layer?** No **# Sub-Samples** 3
Non-Fibrous Components (in approx. decreasing order): binder, perlite, powder

Layers					Percents of Each Fiber					
#	Layer Type	%	Color	Friability	Fib 1	Fib 2	Fib 3	Fib 4	Fib 5	Fib 6
1	acoustical tile	100	Off-white	3	10-20%	<=1%	-	-	-	-
Total %		100	Average %		10-20%	<=1%	-	-	-	-

Fiber Identification: cellulose fiber glass fiber

Fibers								Refractive Index Determinations					
#	Layer Type	Color	Mrph	Iso	Pleo	Bi	Elg	Ext	Oil	Col Par	Col Per	RI Par	RI Per
1	cellulose fiber	W	F	N	N	H	+	U					
2	glass fiber	CL	D	Y									
3													
4													
5													
6													

Sample Analytical Note

Procedure: tweased apart using forceps. Procedure: dissolution of matrix using dilute HCl acid. Procedure: dissolution of matrix using solvent.

Sample M-APL-09B **Lab Number** 2008-02111- 2 **Sampled:** 3/6/2008 **Condition:** acceptable
Analyzed By DJF 3/12/2008 **An?** OK **Apparent Smp Type** Acoustic Tile **Fibrous Solid**
Homogeneous Yes **# Layers** 1 **Pos Layer?** No **# Sub-Samples** 3
Non-Fibrous Components (in approx. decreasing order): binder, perlite, powder

Layers					Percents of Each Fiber					
#	Layer Type	%	Color	Friability	Fib 1	Fib 2	Fib 3	Fib 4	Fib 5	Fib 6
1	acoustical tile	100	Off-white	3	10-20%	<=1%	-	-	-	-
Total %		100	Average %		10-20%	<=1%	-	-	-	-

Fiber Identification: cellulose fiber glass fiber

Fibers								Refractive Index Determinations					
#	Layer Type	Color	Mrph	Iso	Pleo	Bi	Elg	Ext	Oil	Col Par	Col Per	RI Par	RI Per
1	cellulose fiber	W	F	N	N	H	+	U					
2	glass fiber	CL	D	Y									
3													
4													
5													
6													

Sample Analytical Note

Procedure: tweased apart using forceps. Procedure: dissolution of matrix using dilute HCl acid. Procedure: dissolution of matrix using solvent.

Sample M-APL-09C **Lab Number** 2008-02111- 3 **Sampled:** 3/6/2008 **Condition:** acceptable
Analyzed By DJF 3/12/2008 **An?** OK **Apparent Smp Type** Acoustic Tile **Fibrous Solid**
Homogeneous Yes **# Layers** 1 **Pos Layer?** No **# Sub-Samples** 3
Non-Fibrous Components (in approx. decreasing order): binder, perlite, powder

Layers					Percents of Each Fiber					
#	Layer Type	%	Color	Friability	Fib 1	Fib 2	Fib 3	Fib 4	Fib 5	Fib 6
1	acoustical tile	100	Off-white	3	10-20%	<=1%	-	-	-	-
Total %		100	Average %		10-20%	<=1%	-	-	-	-

Fiber Identification: cellulose fiber glass fiber

Fibers								Refractive Index Determinations					
#	Layer Type	Color	Mrph	Iso	Pleo	Bi	Elg	Ext	Oil	Col Par	Col Per	RI Par	RI Per
1	cellulose fiber	W	F	N	N	H	+	U					
2	glass fiber	CL	D	Y									
3													
4													
5													
6													

Sample Analytical Note

Procedure: tweased apart using forceps. Procedure: dissolution of matrix using dilute HCl acid. Procedure: dissolution of matrix using solvent.

Fr=Friability: 1=very non-friable; 2= non-friable; 3=friable; 4=highly friable

Colors: B=black;BL=blue;BR=brown;CL=clear;G=Green;GY=gray;OR=orange;OW=off-white;PN=pink;PU=purple;R=red;TN=tan;W=white;Y=yellow;V=various

Fiber Morphology: A=fine fibers/bundles, white, sinewy, flexible; B=fine fibers/bundles, w-br, straight, broomed ends; C=fine fibers/bundles, blue, straight, broomed ends; D=fine to coarse fibers, CL-B, brittle; E=coarse fibers,CL or dyed, striated; F=coarse fibers or splinters, W-BR, ribbon-like; G=lath-like or shards, low aspect ratio, may taper

Iso=isotropism - may be yes or no; Pleo=pleochroism - may be yes or no; Bi=birefringence - may be None, Low, Medium or High

Elg=sign of elongation - may be +, - or B (both); Ext=extinction - may be Parallel, Oblique, None or Undulating; Oil=medium used to for dispersion staining

Col Par=dispersion staining colors parallel to the fiber (fiber/halo): b/w=black/white; dg/py=dark gray/pale yellow; vg/y=violet gray/yellow; db/ly=dark blue/lemon yellow; vb/g= vivid blue/gold; sb/o=sky blue/orange; pb/r=pale blue/red; gb/dr=gray blue/dark red; w/b=white/black. Col Perp=same only perpendicular to fiber.

RI Par=refractive index parallel to fiber; RI Perp=refractive index perpendicular to fiber

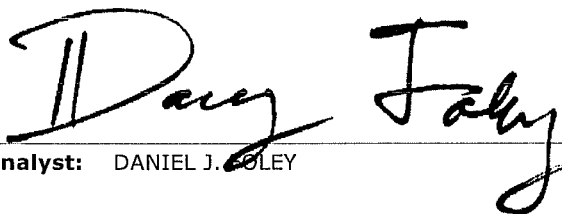

Analyst: DANIEL J. COLEY

Printed: 12-Mar-08

Original Print Date: 12-Mar-08



Larry S. Pierce, Approved Accreditation Signatory



15974 N. 77th Street
Scottsdale, AZ 85260
(602) 277-7877
(602) 277-8288 fax

chain of custody

3

Date: 03/06/08
Project No: 08 085
Initials: MICHAEL RICARTEZ
Page: 1 of 1

Job: VERENE DE LA ESPERANZA
Client: KSD
Address: 14841 S. 41st PLACE

Test: PLM 15-30
Rush: Normal: Extended:
Stop at 1st Positive: X AND
Read all samples:
Call with results:
Fax results:

PORTABLES 73/74

MATERIAL CODE	MATERIAL DESCRIPTION	MATERIAL SAMPLE NO.		LAYERS**
M·APL·09	ACOUSTICAL CEILING PANEL	A-C	BA	S

**Sample Layers - M·MULTIPLE, S·SINGLE

RELINQUISHED BY: 	DATE: <u>3/6/08</u>	RECEIVED BY: <u>K Townsend 17:51</u>	DATE: <u>3-6-08</u>
----------------------	------------------------	---	------------------------



Polarized Light Microscope (PLM) Analysis for Asbestos

JobNumber: 200802112

Client: FM GROUP INC
15974 N 77TH ST

SCOTTSDALE, AZ 85260-0000
Office Phone: (602) 277-7877
FAX: (602) 277-8288

Samples: 3 PLM **Rec:** 3/6/2008 **Method:** EPA 600/R-93/116 PLM analysis for asbestos in bulk smp
Client Job: 08-085/Kyrene De La Esperanza **PO Number:** 08-085
Report Date: 3/12/2008 **Date Analyzed:** 3/12/2008 **Routing Number:** Michael Richter

Method and Analysis Information: Fiberquant Internal SOP: PLMn

Each bulk sample is first dissected under a 7-30x magnification stereo-microscope. This examination is used to determine the general type of sample, how many and what type of layers it has, and initial estimates of fiber types and quantities. Second, liquid media mounts are made of each layer - such mounts may be of selected fibers (used solely for identification purposes) or may be representative of the layer as a whole (used for quantitation purposes). The mounts may be made in a synthetic Canadian balsam, one of several solvents, or in refractive index oils (media of known refractive index). Generally, a variety of different mounts are made: some optimized for fiber visibility, some optimized for fiber identification, and some optimized for fiber quantitation. The mounted slides are then examined at 50-400x magnification on a Nikon Labphot-pol microscope. Optical characteristics are used to identify each observed fiber type; the optical data are contained for each sample on its detail analysis sheet, attached.

Current EPA, NESHAP and OSHA regulations designate a result of $\leq 1\%$ asbestos as "negative" and $> 1\%$ asbestos as "positive". Samples containing layers that have been determined to be "positive" may have to be handled differently during a renovation or demolition than samples whose layers have been determined to be "negative."

The method of fiber analysis and identification is the EPA Method 600/R-93/116. The method of fiber quantitation is an estimation technique in which the analysts quantitation is routinely calibrated by reference quantitation standards, and which has been shown to be equivalent in precision and accuracy to point counting. Friability is estimated for the purposes of deciding when to point count. Friabilities determined in the field take precedence over those determined in the laboratory. Those sample layers which are friable and estimated by the analyst to contain $\leq 1\%$ asbestos are point counted using 400 points. Such point counting is required by NESHAP (National Emission Standards for Hazardous Air Pollutants, Nov. 1990) in order to rely on analytical results that are $\leq 1\%$. The coefficient of variation for the estimation quantitation technique is 100% in the range 0-5%. This means that PLM analysis is not capable of conclusively determining whether a layer containing close to 1% asbestos is actually "positive" or "negative". For this reason, Fiberquant refers to results where asbestos was detected but $\leq 1\%$ as "borderline negative", and results where asbestos was $> 1\%$ but $\leq 2\%$ as "borderline positive" to indicate the uncertainty in assigning a "positive" or "negative" label. In the sample summary, "ND" means that no asbestos was detected during the analysis. A "Tr" or "Trace" of asbestos reported is defined for our purposes as the detection of several asbestos fibers during the analysis; this level would be right at the limit of detection for the method. Trace is only reported on the analysis detail - in the summary a trace would be reported as $\leq 1\%$. The limit of detection (the smallest % of asbestos that can be detected) varies greatly depending on the matrix in which the asbestos is found. As little as 0.001% asbestos can be detected in favorable samples, while detection in unfavorable samples may approach the detection limit of 1% stated in the method. During the analysis, the analyst, for Fiberquant identification purposes only, determines the "apparent sample type" and "apparent layer types." It must be emphasized that these types are only what is apparent. Often, different materials appear similar or identical after sampling, so the analyst may assign a type other than what was sampled.

Floor tiles present a special problem for PLM asbestos analysis. Floor tile can contain chrysotile fibers so thin that they cannot be resolved by optical methods. In such a case, we may observe a percentage of asbestos which is lower than the actual percentage, or not observe asbestos at all when some is present. For this reason, floor tiles reported as negative should be confirmed to be negative using transmission electron microscope (TEM) analysis. Likewise, vermiculite insulation materials containing traces of asbestiform asbestos present a problem for routine PLM analysis - the amphiboles are sometimes present in trace amounts inhomogeneously distributed. We recommend a hydro-separation technique for such samples.

Vermiculite-containing samples may contain trace amounts of asbestiform amphibole that may or may not be detected during routine PLM analysis. For this reason, loose vermiculite samples reported as negative should be confirmed to contain no amphibole using hydroseparation techniques.

The samples were analyzed under the following ongoing quality assurance program: Blank samples are routinely analyzed to maintain contamination-free materials. Each analyst has at least a bachelor's degree in physical science, and has also completed extensive training specific to asbestos analysis for 1-3 months before being allowed to analyze client samples. Qualitative reference samples are routinely analyzed to assure that analysts can identify asbestos and asbestos-look-alike fibers. Quantitative reference samples are routinely analyzed to calibrate and characterize the estimation procedure. Microscope alignment is checked each day. Refractive index oils are calibrated at least quarterly. At least 10% of client samples are re-analyzed from scratch by a different analyst than the original, and any discrepancies are resolved for the sample and similar sample types before the results are reported. All quality checks performed for these samples were in control except as detailed in the "Analytical Notes" below. All analysts participate in interlab round robins and proficiency testing to assure competence. Fiberquant is accredited by NVLAP (#101031) for the analysis of bulk samples for asbestos using PLM. Accreditation does not imply endorsement by the EPA, any other United States governmental agency or any private agency or association. Each lab analysis refers only to the sample tested, and may not, due to the sampling process, be

representative of the material sampled. This report may not be reproduced except in full, without the approval of Fiberquant Analytical Services. Some results may have been calculated using client supplied data, such as volume or area sampled, for which Fiberquant assumes no liability for accuracy.

Job Analysis Notes:

Single layer sample and "Analyze Until Positive Found" criteria were followed where requested by the client on the chain of custody.

PLM Analysis Summary:

Job Number: 200802112 08-085/Kyrene De La Esperanza

Sample Number		Lab Number	Apparent Sample Type *	Positive Layer Yes or No
Layer	Color	Apparent Layer Type *	Asbestos Results	
Sample #	M-APL-09A	2008-02112- 1	Acoustic Tile	Positive Layer? No
Layer # 1	Off-white	acoustical tile	<i>no asbestos detected</i>	
Sample #	M-APL-09B	2008-02112- 2	Acoustic Tile	Positive Layer? No
Layer # 1	Off-white	acoustical tile	<i>no asbestos detected</i>	
Sample #	M-APL-09C	2008-02112- 3	Acoustic Tile	Positive Layer? No
Layer # 1	Off-white	acoustical tile	<i>no asbestos detected</i>	

* Apparent Sample Types and Apparent Layer Types are as they appeared to the analyst. Since many types of materials appear similar after sampling damage, the apparent type of material may not be the actual type of material.

Sample M-APL-09A Lab Number 2008-02112- 1 Sampled: 3/6/2008 Condition: acceptable
 Analyzed By DJF 3/12/2008 An? OK Apparent Smp Type Acoustic Tile Fibrous Mat
 Homogeneous Yes # Layers 1 Pos Layer? No # Sub-Samples 3
 Non-Fibrous Components (in approx. decreasing order): binder, perlite, powder

Layers					Percents of Each Fiber					
#	Layer Type	%	Color	Friability	Fib 1	Fib 2	Fib 3	Fib 4	Fib 5	Fib 6
1	acoustical tile	100	Off-white	3	20-30%	<=1%	-	-	-	-
Total %		100	Average %		20-30%	<=1%	-	-	-	-
Fiber Identification:					cellulose fiber	glass fiber				

Fibers								Refractive Index Determinations				
	Color	Mrph	Iso	Pleo	Bi	Elg	Ext	Oil	Col Par	Col Per	RI Par	RI Per
1	cellulose fiber	W	F	N	N	H	+	U				
2	glass fiber	CL	D	Y								
3												
4												
5												
6												

Sample Analytical Note
 Procedure: tweased apart using forceps. Procedure: dissolution of matrix using acid. Procedure: dissolution of matrix using solvent.

Sample M-APL-09B Lab Number 2008-02112- 2 Sampled: 3/6/2008 Condition: acceptable
 Analyzed By DJF 3/12/2008 An? OK Apparent Smp Type Acoustic Tile Fibrous Mat
 Homogeneous Yes # Layers 1 Pos Layer? No # Sub-Samples 3
 Non-Fibrous Components (in approx. decreasing order): binder, perlite, powder

Layers					Percents of Each Fiber					
#	Layer Type	%	Color	Friability	Fib 1	Fib 2	Fib 3	Fib 4	Fib 5	Fib 6
1	acoustical tile	100	Off-white	3	20-30%	<=1%	-	-	-	-
Total %		100	Average %		20-30%	<=1%	-	-	-	-
Fiber Identification:					cellulose fiber	glass fiber				

Fibers								Refractive Index Determinations				
	Color	Mrph	Iso	Pleo	Bi	Elg	Ext	Oil	Col Par	Col Per	RI Par	RI Per
1	cellulose fiber	W	F	N	N	H	+	U				
2	glass fiber	CL	D	Y								
3												
4												
5												
6												

Sample Analytical Note
 Procedure: tweased apart using forceps. Procedure: dissolution of matrix using acid.

Sample M-APL-09C Lab Number 2008-02112- 3 Sampled: 3/6/2008 Condition: acceptable
 Analyzed By DJF 3/12/2008 An? OK Apparent Smp Type Acoustic Tile Fibrous Mat
 Homogeneous Yes # Layers 1 Pos Layer? No # Sub-Samples 3
 Non-Fibrous Components (in approx. decreasing order): binder, perlite, powder

Layers					Percents of Each Fiber					
#	Layer Type	%	Color	Friability	Fib 1	Fib 2	Fib 3	Fib 4	Fib 5	Fib 6
1	acoustical tile	100	Off-white	3	20-30%	<=1%	-	-	-	-
Total %		100	Average %		20-30%	<=1%	-	-	-	-
Fiber Identification:					cellulose fiber	glass fiber				

Fibers								Refractive Index Determinations				
	Color	Mrph	Iso	Pleo	Bi	Elg	Ext	Oil	Col Par	Col Per	RI Par	RI Per
1	cellulose fiber	W	F	N	N	H	+	U				
2	glass fiber	CL	D	Y								
3												
4												
5												
6												

Sample Analytical Note
 Procedure: tweased apart using forceps. Procedure: dissolution of matrix using acid.

Fr=Friability: 1=very non-friable; 2= non-friable; 3=friable; 4=highly friable

Colors: B=black;BL=blue;BR=brown;CL=clear;G=Green;GY=gray;OR=orange;OW=off-white;PN=pink;PU=purple;R=red;TN=tan;W=white;Y=yellow;V=various

Fiber Morphology: A=fine fibers/bundles, white, sinewy, flexible; B=fine fibers/bundles, w-br, straight, broomed ends; C=fine fibers/bundles, blue, straight, broomed ends; D=fine to coarse fibers, CL-B, brittle; E=coarse fibers,CL or dyed, striated; F=coarse fibers or splinters, W-BR, ribbon-like; G=lath-like or shards, low aspect ratio, may taper

Iso=Isotropism - may be yes or no; Pleo=pleochroism - may be yes or no; Bi=birefringence - may be None, Low, Medium or High

Elg=sign of elongation - may be +, - or B (both); Ext=extinction - may be Parallel, Oblique, None or Undulating; Oil=medium used to for dispersion staining

Col Par=dispersion staining colors parallel to the fiber (fiber/halo): b/w=black/white; dg/py=dark gray/pale yellow; vg/y=violet gray/yellow; db/ly=dark blue/lemon yellow; vb/g= vivid blue/gold; sb/o=sky blue/orange; pb/r=pale blue/red; gb/dr=gray blue/dark red; w/b=white/black. Col Perp=same only perpendicular to fiber.

RI Par=refractive index parallel to fiber; RI Perp=refractive index perpendicular to fiber

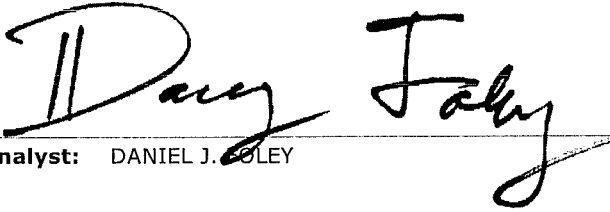

Analyst: DANIEL J. COLEY

Printed: 12-Mar-08

Original Print Date: 12-Mar-08



Larry S. Pierce, Approved Accreditation Signatory

APPENDIX C

Building Inspectors' Signature Sheet

BUILDING INSPECTOR'S SIGNATURE SHEET

Report of Findings
Comprehensive AHERA Asbestos Inspection
Kyrene De La Esperanza Elementary School
Kyrene School District No. 28

FM Project 08-085

The individual(s) whose signature(s) is/are shown below is/are EPA Accredited Building Inspector(s) who participated in one or more of the following activities:

- A. Visual Inspection of Facilities
- B. Identification of Homogenous Areas of Asbestos-Containing Materials
- C. Development of Sampling Plan and Protocols
- D. Bulk Sampling Activities/Material Identifications
- E. Assessing ACBM/ACM
- F. Preparing Report of Findings

<u>INSPECTOR</u>	<u>ACTIVITIES</u>	<u>DATES</u>
<u>Paul Anger</u> Printed Name <u>D 11441</u> Accreditation No. <u>[Signature]</u> Signature	<u>PA</u> Initials <u>EPA</u> State _____ _____	<u>F</u> _____ _____ <u>4/6/08</u>
<u>Michael Richter</u> Printed Name <u>D 10790</u> Accreditation No. <u>[Signature]</u> Signature	<u>MR</u> Initials <u>EPA</u> State _____ _____	<u>A, B, D, E</u> _____ _____ <u>3/4/08 – 3/8/08</u>
<u>Cliff Rolle</u> Printed Name <u>D 10203</u> Accreditation No. <u>[Signature]</u> Signature	<u>CR</u> Initials <u>EPA</u> State _____ _____	<u>A, B, C, D, E, F</u> _____ _____ <u>3/4/08 – 3/6/08</u>
<u>Dane Thompson</u> Printed Name <u>D 9953</u> Accreditation No. <u>[Signature]</u> Signature	<u>DT</u> Initials <u>EPA</u> State _____ _____	<u>A, B, D, E</u> _____ _____ <u>3/4/08 – 3/8/08</u>

APPENDIX D

Personnel and Laboratory Accreditations

THE ASBESTOS INSTITUTE

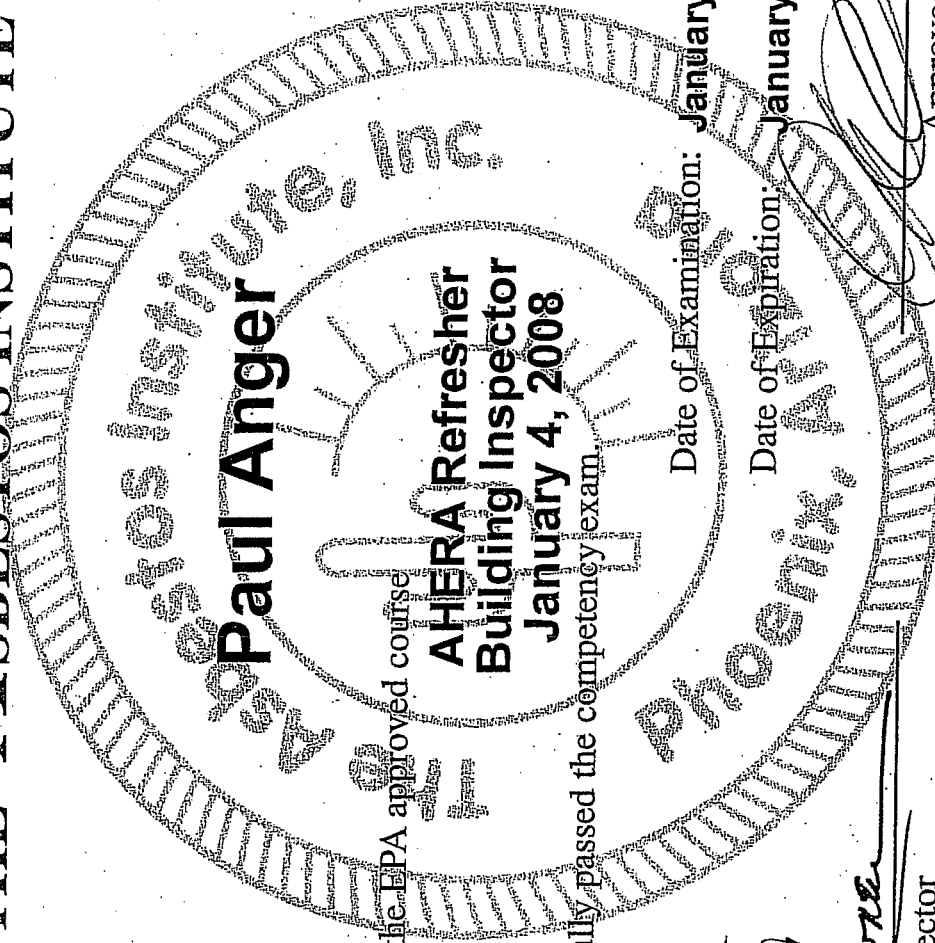

Certifies that

has attended the EPA approved course

**AHERA Refresher
Building Inspector
January 4, 2008**

and successfully passed the competency exam.

Date of Examination: **January 4, 2008**

Date of Expiration: **January 4, 2009**

Director

Approved Instructor

THE ASBESTOS INSTITUTE

8102 North 23rd Avenue

Suite A

Phoenix, AZ 85021-4962

THE ASBESTOS INSTITUTE

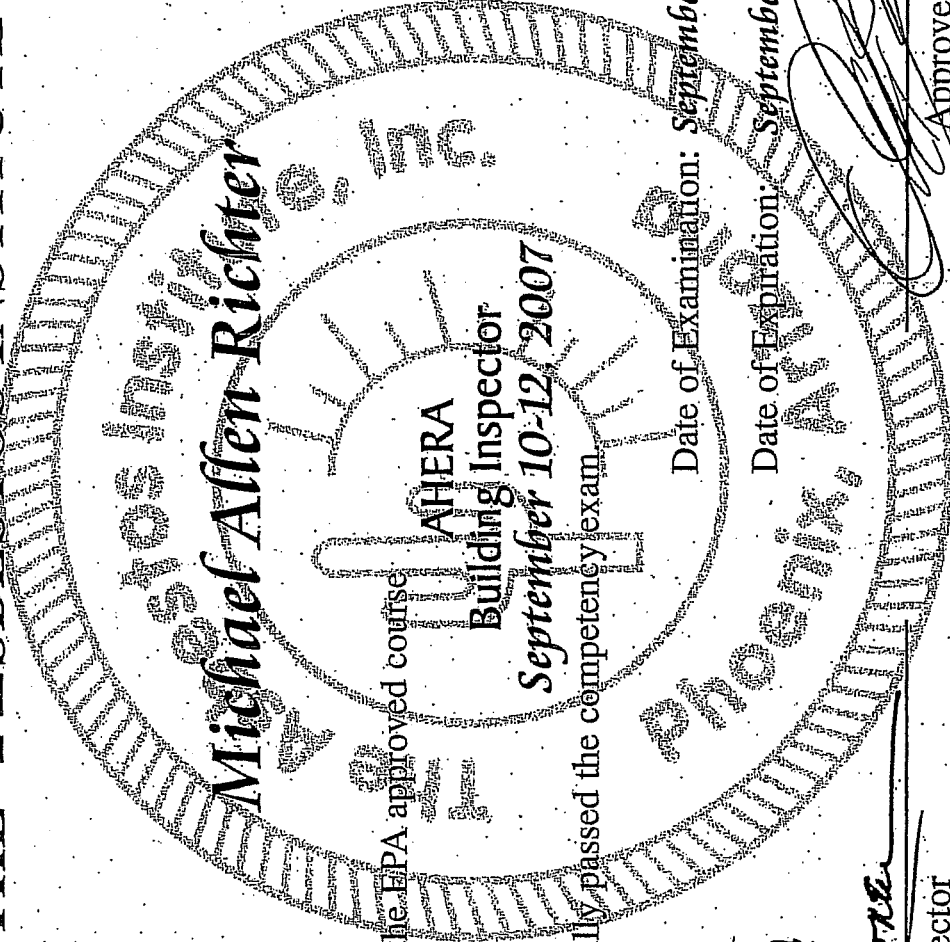

Certifies that

has attended the EPA approved course

AHERA

Building Inspector

September 10-12, 2007

and successfully passed the competency exam

Date of Examination: **September 12, 2007**

Date of Expiration: **September 12, 2008**

[Signature]
 Director

[Signature]
 Approved Instructor

THE ASBESTOS INSTITUTE

8102 North 23rd Avenue

Suite A

Phoenix, AZ 85021-4962

D 10203

THE ASBESTOS INSTITUTE

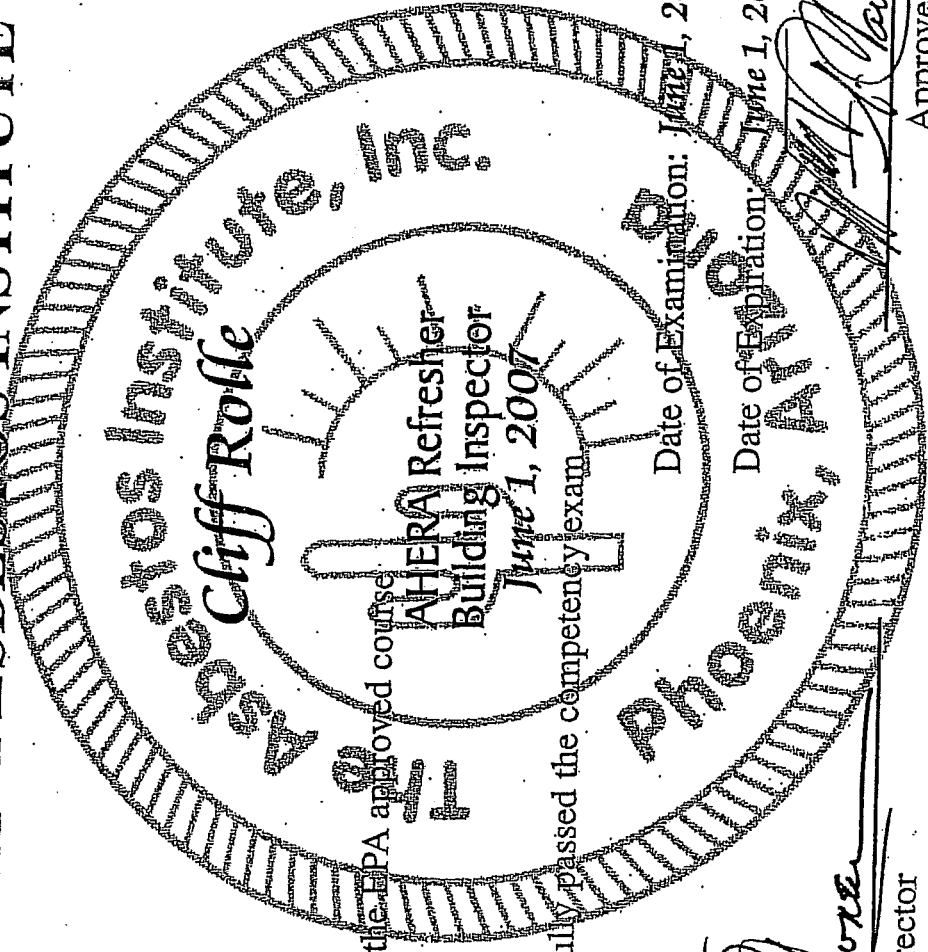

Certifies that

has attended the EPA approved course

**AHERA Refresher
Building Inspector**

June 1, 2007

and successfully passed the competency exam

Date of Examination: **June 1, 2007**

Date of Expiration: **June 1, 2008**

Director

Approved Instructor

THE ASBESTOS INSTITUTE

8102 North 23rd Avenue

Suite A

Phoenix, AZ 85021-4962

602-864-6564

THE ASBESTOS INSTITUTE

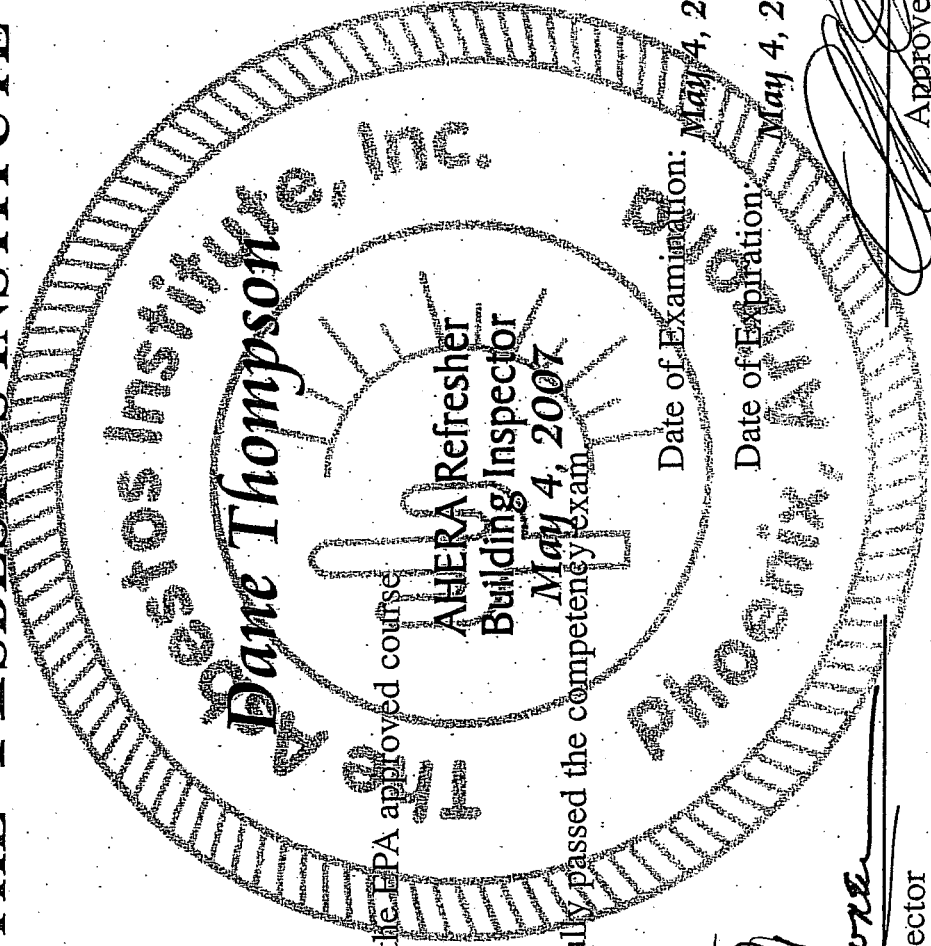

Certifies that

has attended the EPA approved course

**AIIRA Refresher
Building Inspector**

May 4, 2007

and successfully passed the competency exam

Date of Examination: **May 4, 2007**

Date of Expiration: **May 4, 2008**

[Signature]
 Director

[Signature]
 Approved Instructor

THE ASBESTOS INSTITUTE

8102 North 23rd Avenue

Suite A

Phoenix, AZ 85021-4962

602-864-6564

United States Department of Commerce
National Institute of Standards and Technology

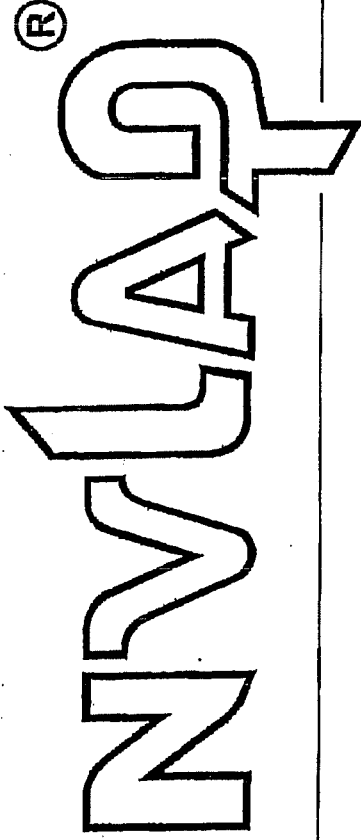

Certificate of Accreditation to ISO/IEC 17025:1999

NVLAP LAB CODE: 101031-0

Fiberquant, Inc.
Phoenix, AZ

is recognized by the National Voluntary Laboratory Accreditation Program for conformance with criteria set forth in
NIST Handbook 150:2001 and all requirements of ISO/IEC 17025:1999.
Accreditation is granted for specific services, listed on the Scope of Accreditation, for:

BULK ASBESTOS FIBER ANALYSIS

2007-07-01 through 2008-06-30

Effective dates



Dolly S. Bruce

For the National Institute of Standards and Technology

APPENDIX E

Homogeneous Material Physical Assessment Forms

Project No.: 08-085 Project Name: AHERA-Compliance Asbestos Inspection Owner: Kyrene School District
 Building No.: Portable P7172 Address: 1481 South 41st Place
 Facility Name: Kyrene De La Esperanza Elementary School Phoenix, Arizona

Functional Space/Designation: N/A
 Functional Space Description: N/A

HOMOGENEOUS MATERIAL INFORMATION

Material Code: M-DST-20
 General Description: Duct Seam Tape
 Location within Functional Space: Ductwork within Plenum
 Material in Air Plenum/Air Shaft/Fan Room/
 Ventilator/Air Stream? Yes No
 Quantity of Material: 10 SF / LF / EA
 Percent of Functional Space: 10

POTENTIAL FOR DISTURBANCE

Potential for Contact: Low Moderate High
 Influence of Vibration: Low Moderate High
 Potential of Air Erosion: Low Moderate High

POTENTIAL FOR DAMAGE

Low Potential for Damage
 Potential for Damage
 Potential for Significant Damage

Preventative Measures:

Comments:

Lead Inspector: Dane Thompson

AHERA Certificate No.: D9953

State License: EPA

Signature:  Date: 3/6/08

Response Action: No Yes SEE MANAGEMENT PLAN

MATERIAL CONDITION

Damage Type and Source: Physical Water Air Erosion
 Vandalism Vibration Flaking
 Deterioration/Age Delamination

Damage Extent: None to very limited visible damage or deterioration - "Good Condition"
 <10% evenly; 10 to 25% locally - "Damaged"
 >10% evenly; > 25% locally - "Significantly Damaged"

Description and Source of Damage:

ASSESSMENT CLASSIFICATIONS

Damaged or significantly damaged TSI ACM
 Damaged friable surfacing ACM
 Significantly damaged friable surfacing ACM
 Damaged or significantly damaged friable miscellaneous ACM
 ACBM with potential for damage
 ACBM with potential for significant damage
 Any remaining friable ACBM or friable suspect ACBM

HOMOGENEOUS MATERIAL PHYSICAL ASSESSMENT FORM



15974 N. 77th Street
 Scottsdale, AZ 85260
 (602) 277-7877
 (602) 277-8288 fax

Project No.: 08-085 Project Name: AHERA-Compliance Asbestos Inspection Owner: Kyrene School District
 Building No.: Portable P73/74 Address: 1481 South 41st Place
 Facility Name: Kyrene De La Esperanza Elementary School Phoenix, Arizona

Functional Space/Designation: N/A
 Functional Space Description: N/A

HOMOGENEOUS MATERIAL INFORMATION

Material Code: M-DSST-20
 General Description: Duct Seam Tape
 Location within Functional Space: Ductwork within Plenum
 Material in Air Plenum/Air Shaft/Fan Room/
 Ventilator/Air Stream? Yes No
 Quantity of Material: 10 SF / LF / EA
 Percent of Functional Space: 10

POTENTIAL FOR DISTURBANCE

Potential for Contact: Low Moderate High
 Influence of Vibration: Low Moderate High
 Potential of Air Erosion: Low Moderate High

POTENTIAL FOR DAMAGE

Low Potential for Damage
 Potential for Damage
 Potential for Significant Damage

Preventative Measures:

Comments:

Response Action: No Yes SEE MANAGEMENT PLAN

MATERIAL CONDITION

Damage Type and Source: Physical Water Air Erosion
 Vandalism Vibration Flaking
 Deterioration/Age Delamination
 Damage Extent: None to very limited visible damage or deterioration - "Good Condition"
 <10% evenly; 10 to 25% locally - "Damaged"
 >10% evenly; > 25% locally - "Significantly Damaged"

Description and Source of Damage:

ASSESSMENT CLASSIFICATIONS

Damaged or significantly damaged TSI ACM
 Damaged friable surfacing ACM
 Significantly damaged friable surfacing ACM
 Damaged or significantly damaged friable miscellaneous ACM
 ACBM with potential for damage
 ACBM with potential for significant damage
 Any remaining friable ACBM or friable suspect ACBM

Lead Inspector: Dane Thompson

AHERA Certificate No.: D9953

State License: EPA

Signature: *[Signature]*

Date: 3/6/08

HOMOGENEOUS MATERIAL PHYSICAL ASSESSMENT FORM



15974 N. 77th Street
 Scottsdale, AZ 85260
 (602) 277-7877
 (602) 277-8288 fax

1.0 SURVEY RESULTS AND RECOMMENDATIONS

1.1 Summary

At the authorization of Kyrene School District No. 28 (KSD), FM GROUP INC (FM), has conducted a Comprehensive Asbestos Hazard Emergency Response Act (AHERA)-Compliant Asbestos Inspection for the three buildings comprising the Kyrene De La Esperanza Elementary School (KDLEES) campus. This inspection was intended to provide information regarding the presence, location and condition of identified Asbestos-Containing Building Materials (ACBM) at the subject facility.

The field portion of the inspection was performed at the subject facility during the period of March 4, 2008 through March 6, 2008. A total of 144 bulk-material samples were collected from 121 suspect ACBM located within the facility. Sampling was conducted in general accordance with the protocols set forth in the Environmental Protection Agency (EPA) AHERA Regulation 40 CFR 763.86. Samples were delivered to Fiberquant Analytical Services (FAS) for analysis by the Polarized Light Microscopy (PLM) methodology.

Seventy-three building materials within the inspected facility have been assumed to be asbestos-containing. The identified ACBM were physically assessed to be non-friable and in good condition, except for duct seam tape, which was assessed to be friable and in good condition.

1.2 Identified Asbestos Containing Building Material

The identified ACBM within the three buildings at KDLEES are presented in tabular form (Table C) in Section 1.3. These tables are organized to show material code, general material description, material locations, laboratory analysis, friability and material quantities. Additionally, ACBM location plans that graphically identify the known extent of these materials by floor plan locations are presented in Section 1.4.

1.3 Asbestos-Containing Building Materials

(Table "C" has been moved to Section 6 of the Management Plan.)

1.4 ACBM/Location Plans

(Drawings have been moved to Section 6 of the Management Plan.)

1.5 Critical Situations

Critical situations are those areas in which the condition of existing ACBM are such as they represent an immediate danger to human health and the environment. **There were NO critical situations observed in the three buildings at KDLEES during this inspection.**

1.6 Friable Asbestos-Containing Building Materials

A friable material is one that when dry can be crumbled, pulverized, or reduced to powder by hand pressure. **There were THREE friable Asbestos-Containing Miscellaneous Building Materials in the three buildings at KDLEES during this inspection.**

- **M·DST·20 – Duct Seam Tape (P71/72)**
- **M·DST·20 – Duct Seam Tape (P73/74)**

1.7 Material Assessments

Due to the fact that **TWO friable Asbestos-Containing Miscellaneous Building Materials** were identified in the three buildings at KDLEES, **TWO** formal assessments are included in this report.

1.8 Recommendations

There are ACBM that have the potential to become damaged during future Operations and Maintenance (O&M) and renovation activities. FM, therefore, recommends that a Management Plan following EPA and Occupational Safety and Health Administration (OSHA) guidelines be developed to address the in-place management of the identified ACBM. In accordance with EPA regulations, a Management Plan must be developed by an EPA Accredited Management Planner.

1.9 Qualifications of Report

FM has endeavored to investigate the existing conditions within the subject facility using that degree of care and skill ordinarily exercised under similar circumstances by asbestos consultants practicing in this, or similar localities. The information contained in this Report is relevant to the dates of FM's site work, and should not be relied on to represent conditions at a substantially later date.

This Report has been prepared on behalf of and exclusively for the use of KSD. This Report and the findings contained herein shall not, in whole or in part, be disseminated or conveyed to any other party or be used or relied upon by any other party, in whole or in part, without FM's prior written consent.

2.0 PROJECT INFORMATION

2.1 Background

KSD intends to determine if there are any ACBM associated with the three buildings at the KDLEES campus. Based on the presumed age of the subject facility, it is likely that ACBM's were included in its construction. In compliance with EPA requirements, specifically its AHERA mandated inspections (40 CFR 763.85), KSD has contracted FM to perform a Comprehensive AHERA Compliant-Asbestos Inspection of the three buildings at the subject facility.

FM was formally engaged by KSD through the acceptance of FM's correspondence for Fee Revision, dated January 16, 2008, as evidenced by the issuance of KSD Purchase Order No.

805886, dated February 8, 2008. The project was coordinated for KSD by Mr. Giacomo Musella, Facilities Supervisor.

The subject facility is located at 14841 South 41st Place, in Phoenix, Arizona and consists of three buildings. The subject facility was occupied and operational at the time of the inspection with access provided by KSD personnel. This inspection was comprehensive by design, including interior and exterior building components and exterior mechanical systems associated with the three buildings.

At the request of KSD, select identified suspect ACBM were sampled, and remaining suspect materials were assumed to be asbestos-containing. No previous asbestos inspections were available for review.

The inspection was performed during the period of March 4, 2008 through March 6, 2008, by Michael Richter and Dane Thompson, both of whom are EPA accredited Building Inspectors. Bulk-material samples were delivered to FAS for analysis by the PLM methodology. FAS is accredited under the American Industrial Hygiene Association's (AIHA) National Institute of Standards and Technology (NIST) National Voluntary Laboratory Accreditation Program (NVLAP).

2.2 Description of Construction

2.2.1 Main Building

The construction date of the Main Building is unknown. The construction appears to be consistent and uniform throughout.

The building is built with a slab on-grade foundation. Perimeter and interior load bearing walls are of concrete masonry systems and wood or metal-framed construction, and support a concrete deck system finished with asphalt prepared roofing systems.

Floor finishes observed include: carpet, ceramic mosaic tile, unfinished concrete, quarry/paver tile, vinyl composition tile and vinyl sheet flooring.

Original walls are concrete masonry systems and wood or metal-framed, gypsum wallboard systems with textured, painted finishes, glazed wall tile, fiberglass reinforced paneling or tackable wall panels. Restroom walls are finished with gypsum wallboard systems with textured, painted finishes and glazed wall tiles. Original ceilings are wood or metal-framed and support gypsum wallboard systems with textured, painted finishes and suspended ceiling systems.

Fire doors were observed to be associated with exterior entrances into the building, corridors and miscellaneous interior rooms.

Mechanical equipment for the building consists of ground and roof-mounted mechanical units. The ductwork distribution systems run above the gypsum wallboard and suspended ceiling systems and are routed into the individual rooms through ceiling or wall-mounted supply registers.

2.2.3 Portables P71/72 and P73/74

The construction date of Portables P71/72 and P73/74 is unknown. The construction appears to be consistent and uniform throughout each Portable.

The buildings are built of wood or metal-framed foundations and are believed to be supported by masonry piers. Perimeter and interior load bearing walls are of wood or metal-framed construction and support wooden truss and deck systems finished with asphalt prepared roofing systems.

Floor finishes observed include: carpet, unfinished concrete and vinyl composition tile.

Original walls are wood or metal framed, gypsum wallboard systems with textured, painted finishes, siding (metal) or tackable wall panels. Original ceilings are wood or metal-framed and support gypsum wallboard systems and suspended ceiling systems.

Fire doors were observed to be associated with exterior entrances into the buildings.

Mechanical equipment for the buildings consists of roof-mounted air handler units. The ductwork distribution systems run above the suspended ceiling systems and are routed into the individual rooms through ceiling or wall-mounted supply registers.

2.3 AHERA Inspection Procedures and Protocols

2.3.1 Inspection Procedures and Protocols

The EPA's AHERA inspection procedures and sampling protocols as called-out in the AHERA Regulations (40 CFR Part 763) requires that all Asbestos-Containing Materials (ACM) utilized within the structure of a regulated "school" building which are called ACBM:

- be identified and located
- be classified as an assumed ACBM or,
- be sampled and analyzed to prove they are NOT ACBM
- be assessed for;
 - ◊ natural friability and,
 - ◊ physical condition and,
 - ◊ if damaged or thermal systems insulation;
 - * be identified for an immediate response action or,
 - * be identified for possible future disturbance and
 - * have preventative measures to reduce potential damage identified.
- have all the forgoing activities conducted and recorded in such a manner as to be able to track;
 - ◊ date accomplished and,
 - ◊ identification and qualification of individuals conducting each activity.

2.3.2 FM GROUP INC Inspection SOP

FM's inspection procedures and protocols have been developed into a logical step by step process designated to accomplish both EPA's AHERA and OSHA's mandates. During inspections, FM will always endeavor to identify all ACM in a structure, whether ACBM or not, so as to limit the possibilities of accidental exposure to contractors or employees during future maintenance or remodeling activities.

2.4 Visual Inspection

A visual inspection of the three buildings was conducted to locate and identify Homogeneous Areas (HA) of suspect ACBM. A HA is defined as an area in which the suspect material appears to be uniform in texture, color, and wear and believed to have been applied during the same general time period. All materials excluding wood; glass; metal; fibrous glass, glass foam and rubber thermal insulation were considered suspect.

2.5 Physical Assessments

A physical assessment of each identified HA of suspect ACBM was conducted to determine what, if any, damage the area has sustained and to determine whether the material should be classified as either friable or non-friable.

The EPA defines a friable material to be one which, when dry, can be crumbled, pulverized, or reduced to powder by hand pressure. Based on this definition of friability, FM ascertained if a material was friable by physically touching each material surface.

At the time of this inspection, **SIX** friable suspect ACBM (acoustical ceiling panels and duct seam tape) were observed. Since **TWO** of these materials were assumed to contain asbestos, **TWO** formal assessments are included in this report.

2.6 Sample Collection

Convenience sampling was performed on select identified suspect ACBM. Destructive sampling activities to access materials within ceiling, floor or wall systems were not utilized. Inspection personnel performing sampling activities utilized proper personnel protection. Additionally, inspection procedures included the use of engineering controls to minimize the release of airborne fibers during sample collection.

Based on FM's sampling strategy, the following number of bulk-material samples was collected from observed suspect ACBM.

Building	Suspect ACBM	Samples Collected
Main	77 (31 Assumed)	138
Portable P71/72	22 (1 Assumed)	3
Portable P73/74	22 (1 Assumed)	3
TOTAL	121	144

2.7 Bulk-Material Sample Analysis

Upon completion of the on-site portion of the work, bulk-material samples accompanied by a Chain-of-Custody form were delivered to FAS for analysis. Samples were analyzed using PLM coupled with dispersion staining as detailed in the EPA's "Interim Method for the Determination of Asbestos Material Insulation Samples" (EPA-66/M4-82-020, December 1982).

PLM is the EPA recommended method for bulk sample analysis and utilizes the unique optical and crystallographic properties of the various constituents of the sample for material identification purposes. These properties, refractive indices, birefringence, sign of elongation, and extinction angle, are characteristically unique to each asbestos form and were used to identify asbestos types present in the samples. Under existing EPA guidelines, the identification of asbestos-form minerals in a single bulk-material sample is sufficient to classify that material as an ACM. On the other hand, a *minimum* of three samples must be identified as not containing asbestos-form minerals to classify that material as non-ACM. All samples of a specific suspect ACM were analyzed until the first sample containing an asbestos-form mineral was found.

END OF REPORT

SECTION 3

DESIGNATED PERSON IDENTIFICATION

AHERA Designated Person
796.93(e)(4)

Owner: KYRENE SCHOOL DISTRICT NO. 28

Address: 8700 SOUTH KYRENE ROAD
TEMPE, ARIZONA 85284-2197

Property: KYRENE DE LA ESPERANZA ELEMENTARY SCHOOL

Address: 14841 SOUTH 41ST PLACE
PHOENIX, ARIZONA 85044

LEA Designated Person

Print Name: Giacomo Musella, Facilities Supervisor

Address: 8700 South Kyrene Road
Tempe, Arizona 85284-2197

Phone: 480.783-4200

Training Course Name: AHERA Building Inspector Refresher

Dates of Training: October 5, 2008 **Hours of Training:** 4

Training Course Name: AHERA Management Planner Refresher

Dates of Training: October 5, 2008 **Hours of Training:** 4

Training Course Name: _____

Dates of Training: _____ **Hours of Training:** _____

Signature

Date

D 10910

THE ASBESTOS INSTITUTE

Certifies that

Giacomo Jack Musella

has attended the EPA approved course

**AHERA Refresher
Building Inspector
October 5, 2007**

and successfully passed the competency exam.

COPY

Date of Examination: **October 5, 2007**

Date of Expiration: **October 5, 2008**



Director



Approved Instructor

THE ASBESTOS INSTITUTE

8102 North 23rd Avenue

Suite A

Phoenix, AZ 85021-4962

602-864-6564

This training meets all requirements for asbestos abatement under TSCA Title II.

D 10936

THE ASBESTOS INSTITUTE

Certifies that
Giacomo Jack Musella

has attended the EPA approved course
AHRA Refresher
Management Planner
October 5, 2007
and successfully passed the competency exam.

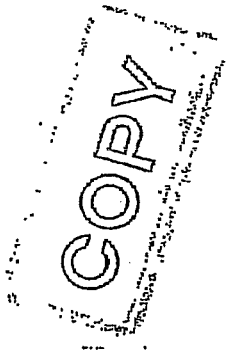

Date of Examination: October 5, 2007

Date of Expiration: October 5, 2008



Director



Approved Instructor

THE ASBESTOS INSTITUTE
8102 North 23rd Avenue
Suite A
Phoenix, AZ 85021-4962
602-864-6564

This training meets all requirements for asbestos accreditation under TSCA Title II.

SECTION 4

RESPONSE ACTION(S)

**Response Actions
Management Planner
763.93(e)(5) and (6)**

PAUL ANGER
Print Name

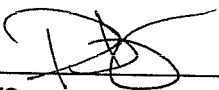
Signature

EPA
State of Accreditation or EPA

D 9213 January 5, 2008
Accreditation No. Date

Date: APRIL 6, 2008

Owner: KYRENE SCHOOL DISTRICT NO. 28

Address: 8700 SOUTH KYRENE ROAD
TEMPE, ARIZONA 85284-2197

Property: KYRENE DE LA ESPERANZA ELEMENTARY SCHOOL

Address: 14841 SOUTH 41ST PLACE
PHOENIX, ARIZONA 85044

Building No.: N/A

Building Name: PORTABLE P71/72

Homogeneous Material Code: M·DST·20

Homogeneous Material Description: DUCT SEAM TAPE

Functional Space(s) Description: OFFICES/CLASSROOMS

Location within Functional Space: CEILINGS

Response Action: Repair Remove O&M
 Encapsulate Enclose

Reason: MATERIAL IS AN ASBESTOS-CONTAINING BUILDING MATERIAL AND COULD
RELEASE FIBERS UPON DISTURBANCE. MATERIAL MUST BE MAINTAINED IN-PLACE.

When (Start/Finish): MAINTAIN MATERIAL IN O&M PLAN UNTIL SCHEDULED FOR
ABATEMENT.

**Response Actions
Management Planner
763.93(e)(5) and (6)**

PAUL ANGER
Print Name

Signature

EPA
State of Accreditation or EPA

D 9213 January 5, 2008
Accreditation No. Date

Date: APRIL 6, 2008

Owner: KYRENE SCHOOL DISTRICT NO. 28

Address: 8700 SOUTH KYRENE ROAD
TEMPE, ARIZONA 85284-2197

Property: KYRENE DE LA ESPERANZA ELEMENTARY SCHOOL

Address: 14841 SOUTH 41ST PLACE
PHOENIX, ARIZONA 85044

Building No.: N/A

Building Name: PORTABLE P73/74

Homogeneous Material Code: M·DST·20

Homogeneous Material Description: DUCT SEAM TAPE

Functional Space(s) Description: OFFICES/CLASSROOMS

Location within Functional Space: CEILINGS

Response Action: Repair Remove O&M
 Encapsulate Enclose

Reason: MATERIAL IS AN ASBESTOS-CONTAINING BUILDING MATERIAL AND COULD
RELEASE FIBERS UPON DISTURBANCE. MATERIAL MUST BE MAINTAINED IN-PLACE.

When (Start/Finish): MAINTAIN MATERIAL IN O&M PLAN UNTIL SCHEDULED FOR
ABATEMENT.

SECTION 5

ACCREDITATION STATEMENTS

**Assurance of Accreditation
Under this Management Plan
763.93(e)(7)**

Inspector(s):

Name: MICHAEL RICHTER
State of Accreditation or EPA: EPA
Accreditation Date(s): SEPTEMBER 12, 2008
Accreditation Number(s): D 10790

Name: CLIFF ROLLE
State of Accreditation or EPA: EPA
Accreditation Date(s): JUNE 1, 2008
Accreditation Number(s): D10203

Name: DANE THOMPSON
State of Accreditation or EPA: EPA
Accreditation Date(s): MAY 4, 2008
Accreditation Number(s): D 9953

Management Planner:

Name: PAUL ANGER
State of Accreditation or EPA: EPA
Accreditation Date(s): JANUARY 5, 2008
Accreditation Number(s): D 11466

Any Project Designer, Contractor/Supervisor or Worker who performs work on response actions under this Management Plan shall be accredited by either an EPA approved state contractor accreditation plan or an EPA approved course under Section 206(b) to Title II of the Toxic Substance Control Act.

D 10790

THE ASBESTOS INSTITUTE

Certifies that

has attended the EPA approved course

AIHRA

Building Inspector

September 10-12, 2007

and successfully passed the competency exam.

Date of Examination: **September 12, 2007**

Date of Expiration: **September 12, 2008**

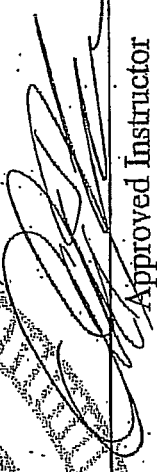
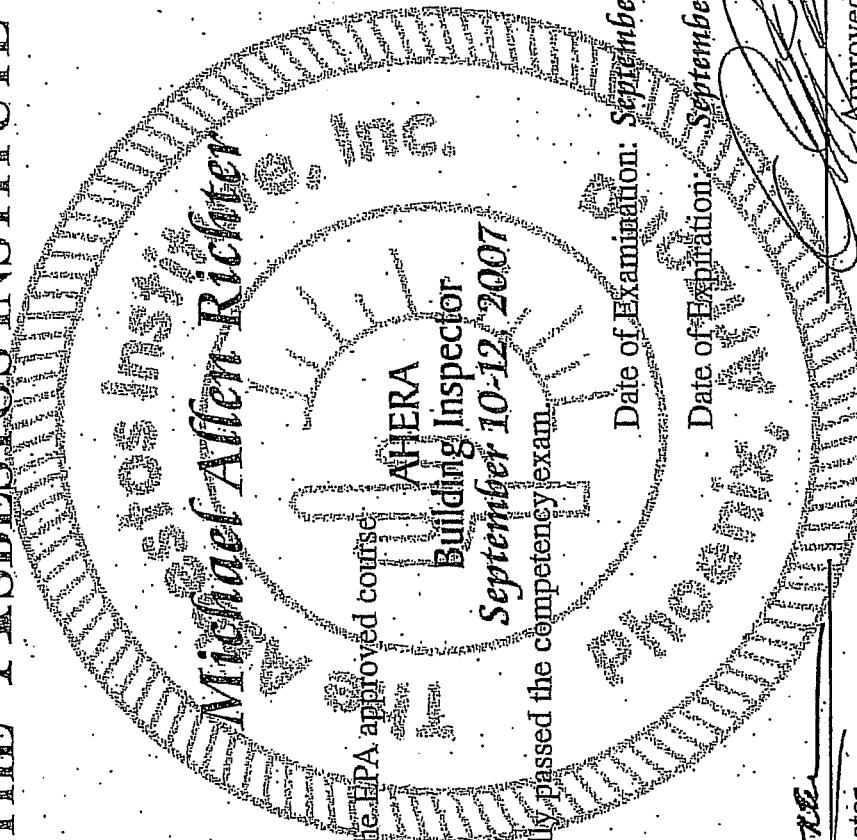

Director

Approved Instructor

THE ASBESTOS INSTITUTE

8102 North 23rd Avenue

Suite A

Phoenix, AZ 85021-4962

602-864-6564

D 10203

THE ASBESTOS INSTITUTE

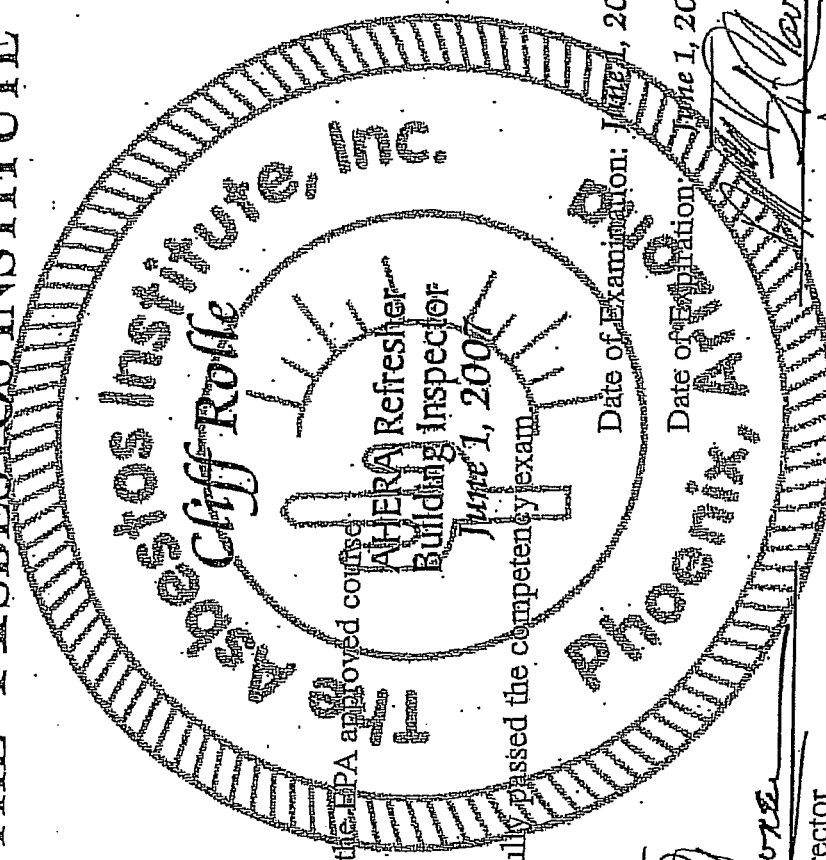

Certifies that

has attended the EPA approved course

AHERA Refresher
Building Inspector

June 1, 2007

and successfully passed the competency exam

Date of Examination: June 1, 2007

Date of Expiration: June 1, 2008

Director

Approved Instructor

THE ASBESTOS INSTITUTE

8102 North 23rd Avenue

Suite A

Phoenix, AZ 85021-4962

602-864-6564

This training meets all requirements for asbestos accreditation under TSCA Title II.

THE ASBESTOS INSTITUTE

Certifies that

has attended the EPA approved course

**AHERA Refresher
Building Inspector**

and successfully passed the competency exam

May 4, 2007

Date of Examination: **May 4, 2007**

Date of Expiration: **May 4, 2008**

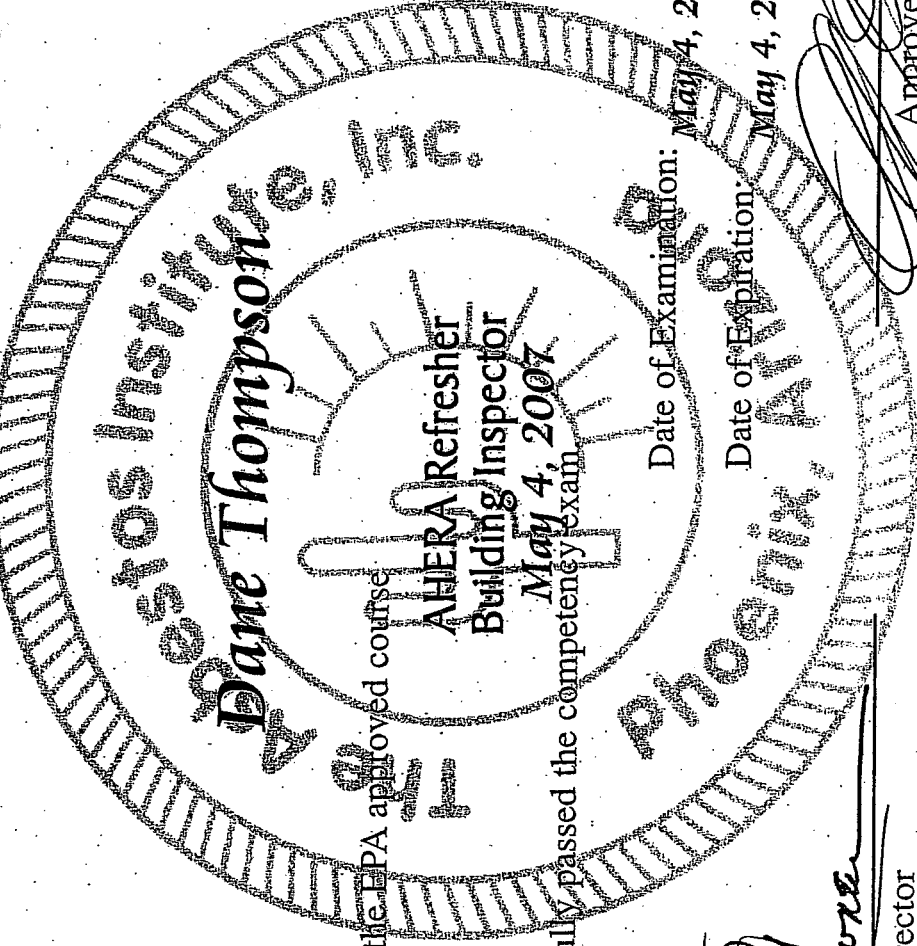

[Signature]
 Director

[Signature]
 Approved Instructor

THE ASBESTOS INSTITUTE

8102 North 23rd Avenue

Suite A

Phoenix, AZ 85021-4962

602-864-6564

THE ASBESTOS INSTITUTE

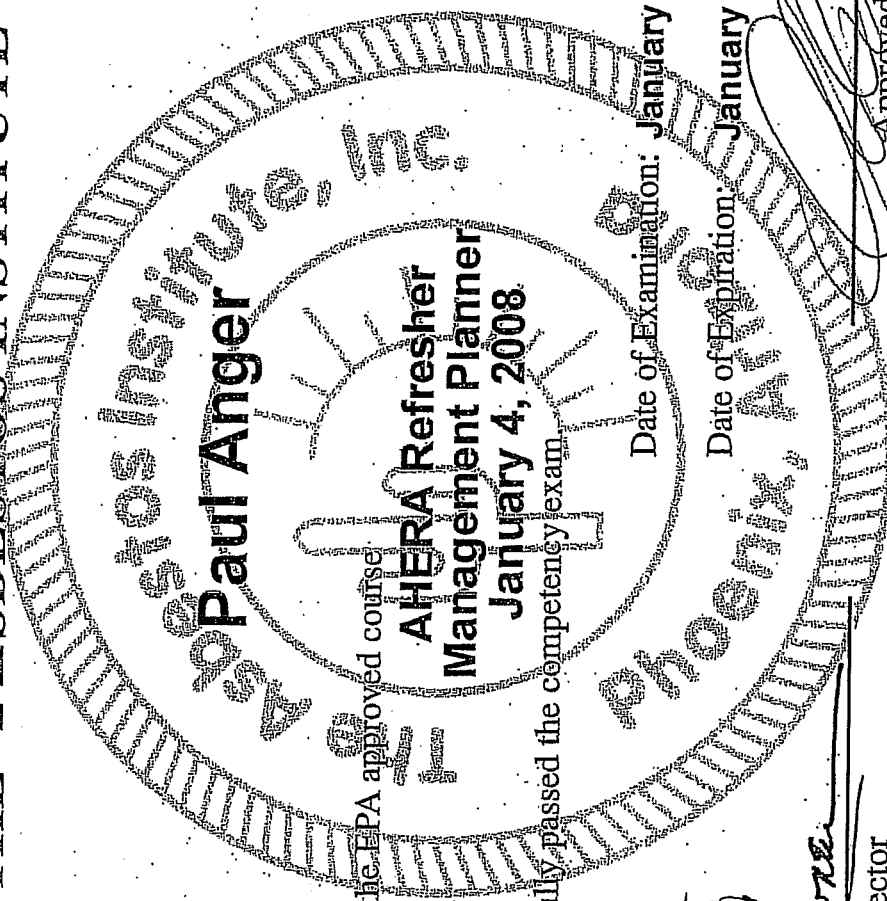

Certifies that

has attended the EPA approved course

**AHERA Refresher
Management Planner
January 4, 2008**

and successfully passed the competency exam.

Date of Examination: **January 4, 2008**

Date of Expiration: **January 4, 2009**

[Signature]
Director

[Signature]
Approved Instructor

THE ASBESTOS INSTITUTE

8102 North 23rd Avenue

Suite A

Phoenix, AZ 85021-4962

602-864-6564

SECTION 6

REMAINING ACBM

JOB NAME: *Comprehensive AHERA Asbestos Inspection
Kyrene De La Esperanza Elementary School, KSD
Main Building*

JOB NO. 08-085

**TABLE C
ASBESTOS CONTAINING BUILDING MATERIALS**

MATERIAL CODE	MATERIAL DESCRIPTION	MATERIAL LOCATION	MATERIAL COMPONENT	COMPONENT LOCATION	LAB ANALYSIS RESULTS	F/NF	MTL QUAN	UNITS
M-QPT-07	QUARRY/PAVER TILE, 8"X8", RED, SMOOTH	ROOM 35	W	N, E	ASSUMED	NF	13	SF
		CORRIDOR C-04	W	W, S				
		EXTERIOR	W	N, E, W, S				
M-GWT-10	GLAZED WALL TILE, 8"X8", WHITE, SMOOTH, MULTI-COLORED, HAND PAINTED DESIGNS	EXTERIOR	W	N, E, W, S	ASSUMED	NF	120	SF
M-GRT-11	GROUT, GRAY, CEMENTITIOUS, ASSOCIATED WITH GLAZED WALL TILE, 8"X8", WHITE, SMOOTH, MULTI-COLORED, HAND PAINTED DESIGNS	EXTERIOR	W	N, E, W, S	ASSUMED	NF	12	SF
M-CON-14	CONCRETE (EQUIPMENT PAD), GRAY, CEMENTITIOUS	CHILLER YARD	F	*	ASSUMED	NF	1,000	SF
M-BUR-18	BUILT-UP ROOFING, BLACK, ASPHALTIC, GRAY MINERAL CAP, SILVER COATING	ROOF	O	*	ASSUMED	NF	60,000	SF
M-MAS-19	MASTIC (PENETRATIONS AND FLASHINGS), BLACK, TAR-LIKE	ROOF	O	*	ASSUMED	NF	100	SF
M-FDI-27	FIRE DOOR INSULATION, WOOD CLADDING	RECEPTION	O	E, S	ASSUMED	NF	1,806	SF
		FIRE RISER	O	S				
		STAFF LOUNGE	O	N, S				
		JANITOR OFFICE	O	N, S				
		PRINCIPAL	O	W				
		ASSISTANT PRINCIPAL	O	N				
		STORAGE 1	O	N				
		ELECTRICAL 1	O	E				
		MEN'S RESTROOM	O	W				
		WOMEN'S RESTROOM	O	W				
		ROOM 12	O	N				
		ROOM 13	O	E				
		ROOM 14	O	E				
		ROOM 15	O	W				

JOB NAME: *Comprehensive AHERA Asbestos Inspection
Kyrene De La Esperanza Elementary School, KSD
Main Building*

JOB NO. 08-085

MATERIAL CODE	MATERIAL DESCRIPTION	MATERIAL LOCATION	MATERIAL COMPONENT	COMPONENT LOCATION	LAB ANALYSIS RESULTS	F/NF	MTL QUAN	UNITS
		ROOM 16	O	W				
		ROOM 17	O	W				
		ROOM 18	O	E				
		ROOM 19	O	E				
		ROOM 20	O	E				
		GIRL'S RESTROOM 1	O	W				
		BOY'S RESTROOM 1	O	W				
		ROOM 21	O	W				
		ROOM 22	O	W				
		ROOM 24	O	N				
		ROOM 25	O	E				
		ROOM 26	O	E				
		ROOM 28	O	W				
		ROOM 29	O	W				
		ROOM 30	O	W				
		ROOM 31	O	N				
		ROOM 34	O	N, E, W				
		ROOM 34A	O	W				
		ROOM 35	O	N, E, W, S				
		ROOM 35A	O	S				
		ROOM 35B	O	S				
		WEST WING	O	N, S				
		STAGE	O	E				
		EAST WING	O	W				
		ROOM 36	O	W				
		ROOM 37	O	E, W				
		ROOM 38	O	N, W				
		ROOM 38A	O	S				

JOB NAME: *Comprehensive AHERA Asbestos Inspection
 Kyrene De La Esperanza Elementary School, KSD
 Main Building*

JOB NO. 08-085

MATERIAL CODE	MATERIAL DESCRIPTION	MATERIAL LOCATION	MATERIAL COMPONENT	COMPONENT LOCATION	LAB ANALYSIS RESULTS	F/NF	MTL QUAN	UNITS
		KITCHEN YARD	O	W				
		ROOM 66	O	W				
		ROOM 66A	O	E, S				
		ROOM 67	O	S				
		ROOM 39	O	W				
		ROOM 40	O	W				
		ROOM 41	O	S				
		GIRL'S RESTROOM 2	O	S				
		BOY'S RESTROOM 2	O	W				
		JANITOR 2	O	W				
		ROOM 42	O	E				
		ROOM 43	O	E				
		ROOM 45	O	W				
		ROOM 46	O	W				
		ROOM 48	O	E				
		ROOM 49	O	E				
		ROOM 50	O	E				
		ROOM 51	O	S				
		FOYER 1	O	E, W, S				
		ROOM 54	O	E, W				
		ROOM 55	O	E				
		ROOM 55A	O	W				
		ROOM 56	O	W, S				
		ROOM 57	O	N				
		ROOM 57A	O	S				
		ROOM 58	O	N				
		ROOM 59	O	E				
		ROOM 60	O	S				

JOB NAME: *Comprehensive AHERA Asbestos Inspection
Kyrene De La Esperanza Elementary School, KSD
Main Building*

JOB NO. 08-085

MATERIAL CODE	MATERIAL DESCRIPTION	MATERIAL LOCATION	MATERIAL COMPONENT	COMPONENT LOCATION	LAB ANALYSIS RESULTS	F/NF	MTL QUAN	UNITS
		ROOM 61	O	N, S				
		ROOM 61A	O	S				
		FOYER 2	O	N, E, W				
		ROOM 62	O	E, W				
		ROOM 62A	O	W				
		ROOM 63	O	N, S				
		ROOM 63A	O	N				
		CORRIDOR C-01	O	N				
		CORRIDOR C-02	O	N, E, W, S				
		CORRIDOR C-03	O	E, W				
		CORRIDOR C-04	O	N, S				
		CORRIDOR C-05	O	N, E, W, S				
		CORRIDOR C-06	O	E, W				
		CORRIDOR C-07	O	E, W				
		CORRIDOR C-08	O	W, S				
		CORRIDOR C-09	O	N, E, W, S				
		CORRIDOR C-10	O	E, W				
		CORRIDOR C-11	O	E, W				
		CORRIDOR C-12	O	N, S				
		CORRIDOR C-13	O	E, W				
M-PSL-28	PIPE SEALANT, YELLOW, PLIABLE	RECEPTION	O	*	ASSUMED	NF	75	SF
		TREATMENT	O	*				
		NURSE 1	O	*				
		NURSE RESTROOM	O	*				
		FIRE RISER	O	*				
		NURSE 2	O	*				
		WORKROOM	O	*				
		OFFICE 1	O	*				

JOB NAME: *Comprehensive AHERA Asbestos Inspection
Kyrene De La Esperanza Elementary School, KSD
Main Building*

JOB NO. 08-085

MATERIAL CODE	MATERIAL DESCRIPTION	MATERIAL LOCATION	MATERIAL COMPONENT	COMPONENT LOCATION	LAB ANALYSIS RESULTS	F/NF	MTL QUAN	UNITS
		PHONE	0	*				
		STAFF LOUNGE	0	*				
		JANITOR OFFICE	0	*				
		ELECTRICAL 2	0	*				
		PRINCIPAL	0	*				
		PRINCIPAL CLOSET	0	*				
		ASSISTANT PRINCIPAL	0	*				
		STORAGE 1	0	*				
		ELECTRICAL 1	0	*				
		MEN'S RESTROOM	0	*				
		WOMEN'S RESTROOM	0	*				
		ROOM 12	0	*				
		ROOM 12A	0	*				
		12 RESTROOM	0	*				
		ROOM 13	0	*				
		ROOM 13A	0	*				
		13 RESTROOM	0	*				
		ROOM 14	0	*				
		14 RESTROOM	0	*				
		ROOM 15	0	*				
		ROOM 16	0	*				
		ROOM 17	0	*				
		ROOM 18	0	*				
		ROOM 19	0	*				
		ROOM 20	0	*				
		POD 1	0	*				
		JANITOR 1	0	*				
		GIRL'S RESTROOM 1	0	*				

JOB NAME: *Comprehensive AHERA Asbestos Inspection
Kyrene De La Esperanza Elementary School, KSD
Main Building*

JOB NO. 08-085

MATERIAL CODE	MATERIAL DESCRIPTION	MATERIAL LOCATION	MATERIAL COMPONENT	COMPONENT LOCATION	LAB ANALYSIS RESULTS	F/NF	MTL QUAN	UNITS
		BOY'S RESTROOM 1	0	*				
		CHILLER YARD	0	*				
		ROOM 21	0	*				
		ROOM 22	0	*				
		ROOM 23	0	*				
		ROOM 24	0	*				
		ROOM 25	0	*				
		ROOM 26	0	*				
		ROOM 27	0	*				
		POD 2	0	*				
		ROOM 28	0	*				
		ROOM 29	0	*				
		ROOM 30	0	*				
		ROOM 31	0	*				
		ROOM 32	0	*				
		ROOM 33	0	*				
		POD 3	0	*				
		ROOM 34	0	*				
		ROOM 34A	0	*				
		JANITOR 3	0	*				
		BOY'S RESTROOM 3	0	*				
		GIRL'S RESTROOM 3	0	*				
		ROOM 35	0	*				
		ROOM 35A	0	*				
		ROOM 35B	0	*				
		WEST WING	0	*				
		STAGE	0	*				
		EAST WING	0	*				

JOB NAME: *Comprehensive AHERA Asbestos Inspection
 Kyrene De La Esperanza Elementary School, KSD
 Main Building*

JOB NO. 08-085

MATERIAL CODE	MATERIAL DESCRIPTION	MATERIAL LOCATION	MATERIAL COMPONENT	COMPONENT LOCATION	LAB ANALYSIS RESULTS	F/NF	MTL QUAN	UNITS
		ROOM 36	O	*				
		ROOM 37	O	*				
		ROOM 37A	O	*				
		ROOM 38	O	*				
		ROOM 38A	O	*				
		ROOM 66	O	*				
		ROOM 66A	O	*				
		ROOM 67	O	*				
		ROOM 39	O	*				
		ROOM 40	O	*				
		ROOM 41	O	*				
		ROOM 41A	O	*				
		GIRL'S RESTROOM 2	O	*				
		BOY'S RESTROOM 2	O	*				
		JANITOR 2	O	*				
		ROOM 42	O	*				
		ROOM 43	O	*				
		ROOM 44	O	*				
		ROOM 45	O	*				
		ROOM 46	O	*				
		ROOM 47	O	*				
		POD 4	O	*				
		ROOM 48	O	*				
		ROOM 49	O	*				
		ROOM 50	O	*				
		ROOM 51	O	*				
		ROOM 52	O	*				
		ROOM 53	O	*				

JOB NAME: *Comprehensive AHERA Asbestos Inspection
Kyrene De La Esperanza Elementary School, KSD
Main Building*

JOB NO. 08-085

MATERIAL CODE	MATERIAL DESCRIPTION	MATERIAL LOCATION	MATERIAL COMPONENT	COMPONENT LOCATION	LAB ANALYSIS RESULTS	F/NF	MTL QUAN	UNITS
		POD 5	O	*				
		FOYER 1	O	*				
		ROOM 54	O	*				
		ROOM 55	O	*				
		ROOM 55A	O	*				
		ROOM 56	O	*				
		ROOM 56A	O	*				
		ROOM 57	O	*				
		ROOM 57A	O	*				
		ROOM 58	O	*				
		ROOM 59	O	*				
		ROOM 59A	O	*				
		ROOM 59B	O	*				
		ROOM 60	O	*				
		ROOM 61	O	*				
		ROOM 61A	O	*				
		FOYER 2	O	*				
		ROOM 62	O	*				
		ROOM 62A	O	*				
		ROOM 63	O	*				
		ROOM 63A	O	*				
		CORRIDOR C-01	O	*				
		CORRIDOR C-02	O	*				
		CORRIDOR C-03	O	*				
		CORRIDOR C-04	O	*				
		CORRIDOR C-05	O	*				
		CORRIDOR C-06	O	*				
		CORRIDOR C-07	O	*				

JOB NAME: *Comprehensive AHERA Asbestos Inspection
Kyrene De La Esperanza Elementary School, KSD
Main Building*

JOB NO. 08-085

MATERIAL CODE	MATERIAL DESCRIPTION	MATERIAL LOCATION	MATERIAL COMPONENT	COMPONENT LOCATION	LAB ANALYSIS RESULTS	F/NF	MTL QUAN	UNITS
		CORRIDOR C-08	O	*				
		CORRIDOR C-09	O	*				
		CORRIDOR C-10	O	*				
		CORRIDOR C-11	O	*				
		CORRIDOR C-12	O	*				
		CORRIDOR C-13	O	*				
M-FDI-44	FIRE DOOR INSULATION, METAL CLADDING	RECEPTION	O	W	ASSUMED	NF	903	SF
		TREATMENT	O	W				
		WORK ROOM	O	N				
		JANITOR OFFICE	O	S				
		ELECTRICAL 2	O	N				
		ROOM 12	O	W				
		ROOM 12A	O	S				
		ROOM 13	O	W				
		ROOM 13A	O	N				
		ROOM 14	O	W				
		ROOM 23	O	W				
		ROOM 27	O	E				
		ROOM 32	O	E				
		ROOM 33	O	E				
		ROOM 34	O	S				
		BOY'S RESTROOM 3	O	N				
		GIRL'S RESTROOM 3	O	N				
		ROOM 35	O	N, E				
		ROOM 37	O	E				
		ROOM 37A	O	E				
		KITCHEN YARD	O	W				
		ROOM 40	O	N				

JOB NAME: *Comprehensive AHERA Asbestos Inspection
Kyrene De La Esperanza Elementary School, KSD
Main Building*

JOB NO. 08-085

MATERIAL CODE	MATERIAL DESCRIPTION	MATERIAL LOCATION	MATERIAL COMPONENT	COMPONENT LOCATION	LAB ANALYSIS RESULTS	F/NF	MTL QUAN	UNITS
		ART PATIO	O	S				
		ROOM 44	O	E				
		ROOM 47	O	W				
		ROOM 52	O	W				
		ROOM 53	O	W				
		CORRIDOR C-03	O	N				
		CORRIDOR C-04	O	W, S				
		CORRIDOR C-06	O	N				
		CORRIDOR C-08	O	E				
		CORRIDOR C-10	O	S				
		CORRIDOR C-11	O	S				
		CORRIDOR C-12	O	W				
		CORRIDOR C-13	O	S				
		EXTERIOR	O	N, E, W, S				
M-GWT-51	GLAZED WALL TILE, 4"X4", TAN, SMOOTH	GIRL'S RESTROOM 1	W	N, E, W, S	ASSUMED	NF	5,000	SF
		BOY'S RESTROOM 1	W	N, E, W, S				
		BOY'S RESTROOM 3	W	N, E, W, S				
		GIRL'S RESTROOM 3	W	N, E, W, S				
		ROOM 66	W	N, E, W, S				
		ROOM 67	W	N, E, W, S				
		GIRL'S RESTROOM 2	W	N, E, W, S				
		BOY'S RESTROOM 2	W	N, E, W, S				
		ROOM 62	W	N, E, W, S				
		ROOM 63	W	N, E, W, S				
M-GWT-52	GLAZED WALL TILE (PATTERN), 4"X4", BLUE, SMOOTH	GIRL'S RESTROOM 1	W	N, E, W, S	ASSUMED	NF	1,000	SF
		BOY'S RESTROOM 1	W	N, E, W, S				
		BOY'S RESTROOM 3	W	N, E, W, S				
		GIRL'S RESTROOM 3	W	N, E, W, S				

JOB NAME: *Comprehensive AHERA Asbestos Inspection
Kyrene De La Esperanza Elementary School, KSD
Main Building*

JOB NO. 08-085

MATERIAL CODE	MATERIAL DESCRIPTION	MATERIAL LOCATION	MATERIAL COMPONENT	COMPONENT LOCATION	LAB ANALYSIS RESULTS	F/NF	MTL QUAN	UNITS
		ROOM 66	W	N, E, W, S				
		ROOM 67	W	N, E, W, S				
		GIRL'S RESTROOM 2	W	N, E, W, S				
		BOY'S RESTROOM 2	W	N, E, W, S				
		ROOM 62	W	N, E, W, S				
		ROOM 63	W	N, E, W, S				
M-GRT-53	GROUT, GRAY, CEMENTITIOUS, ASSOCIATED WITH GLAZED WALL TILE, 4"X4", TAN, SMOOTH AND GLAZED WALL TILE (PATTERN), 4"X4", BLUE, SMOOTH	GIRL'S RESTROOM 1	W	N, E, W, S	ASSUMED	NF	600	SF
		BOY'S RESTROOM 1	W	N, E, W, S				
		BOY'S RESTROOM 3	W	N, E, W, S				
		GIRL'S RESTROOM 3	W	N, E, W, S				
		ROOM 66	W	N, E, W, S				
		ROOM 67	W	N, E, W, S				
		GIRL'S RESTROOM 2	W	N, E, W, S				
		BOY'S RESTROOM 2	W	N, E, W, S				
		ROOM 62	W	N, E, W, S				
		ROOM 63	W	N, E, W, S				
M-CMT-54	CERAMIC MOSAIC TILE, 2"X2", TAN, SMOOTH, PEPPERED	GIRL'S RESTROOM 1	F	*	ASSUMED	NF	3,200	SF
		BOY'S RESTROOM 1	F	*				
		BOY'S RESTROOM 3	F	*				
		GIRL'S RESTROOM 3	F	*				
		ROOM 66	F	*				
		ROOM 67	F	*				
		GIRL'S RESTROOM 2	F	*				
		BOY'S RESTROOM 2	F	*				
		ROOM 62	F	*				

JOB NAME: *Comprehensive AHERA Asbestos Inspection
Kyrene De La Esperanza Elementary School, KSD
Main Building*

JOB NO. 08-085

MATERIAL CODE	MATERIAL DESCRIPTION	MATERIAL LOCATION	MATERIAL COMPONENT	COMPONENT LOCATION	LAB ANALYSIS RESULTS	F/NF	MTL QUAN	UNITS
		ROOM 63	F	*				
M·GRT·55	GROUT, GRAY, CEMENTITIOUS, ASSOCIATED WITH CERAMIC MOSAIC TILE, 2"X2", TAN, SMOOTH, PEPPERED	GIRL'S RESTROOM 1	F	*	ASSUMED	NF	320	SF
		BOY'S RESTROOM 1	F	*				
		BOY'S RESTROOM 3	F	*				
		GIRL'S RESTROOM 3	F	*				
		ROOM 66	F	*				
		ROOM 67	F	*				
		GIRL'S RESTROOM 2	F	*				
		BOY'S RESTROOM 2	F	*				
		ROOM 62	F	*				
		ROOM 63	F	*				
M·ADH·56	ADHESIVE, BROWN, BRITTLE, ASSOCIATED WITH FIBERGLASS REINFORCED PANEL, WHITE, TEXTURED	ROOM 37	W	E, W, S	ASSUMED	NF	100	SF
		JANITOR 2	W	N, E				
		ROOM 62A	W	N, E				
M·PSL·57	PIPE SEALANT, GREEN, GUMMY	CHILLER YARD	O	*	ASSUMED	NF	2	SF
M·SLT·58	SEALANT (EQUIPMENT), BLACK, GUMMY	CHILLER YARD	O	*	ASSUMED	NF	2	SF
M·APL·59	ACOUSTICAL CEILING PANEL, 2'X2', YELLOW, FIBROUS GLASS, CLOTH COVER	ROOM 54	C	*	ASSUMED	NF	1,750	SF
		ROOM 57	C	*				
S·SAT·66	SPRAY-APPLIED TEXTURE, WHITE, CHALKY	ENTRY	C, W	N, E, W, S	ASSUMED	NF	3,000	SF
		KITCHEN	C, W	N, E, W, S				
		BEDROOM 1	C, W	N, E, W, S				
		RESTROOM 1	C, W	N, E, W, S				
		LIVING ROOM	C, W	N, E, W, S				
		RESTROOM 2	C, W	N, E, W, S				

JOB NAME: *Comprehensive AHERA Asbestos Inspection
Kyrene De La Esperanza Elementary School, KSD
Main Building*

JOB NO. 08-085

MATERIAL CODE	MATERIAL DESCRIPTION	MATERIAL LOCATION	MATERIAL COMPONENT	COMPONENT LOCATION	LAB ANALYSIS RESULTS	F/NF	MTL QUAN	UNITS
		BEDROOM 2	C, W	N, E, W, S				
M-GWB-67	GYPSUM WALLBOARD, WHITE, CHALKY, ASSOCIATED WITH SPRAY-APPLIED TEXTURE, WHITE, CHALKY	ENTRY	C, W	N, E, W, S	ASSUMED	NF	3,000	SF
		KITCHEN	C, W	N, E, W, S				
		BEDROOM 1	C, W	N, E, W, S				
		RESTROOM 1	C, W	N, E, W, S				
		LIVING ROOM	C, W	N, E, W, S				
		RESTROOM 2	C, W	N, E, W, S				
		BEDROOM 2	C, W	N, E, W, S				
S-JTC-68	JOINT COMPOUND, WHITE, CHALKY, ASSOCIATED WITH GYPSUM WALLBOARD, WHITE, CHALKY	ENTRY	C, W	N, E, W, S	ASSUMED	NF	300	SF
		KITCHEN	C, W	N, E, W, S				
		BEDROOM 1	C, W	N, E, W, S				
		RESTROOM 1	C, W	N, E, W, S				
		LIVING ROOM	C, W	N, E, W, S				
		RESTROOM 2	C, W	N, E, W, S				
		BEDROOM 2	C, W	N, E, W, S				
M-QPT-69	QUARRY/PAVER TILE, 8"X8", WHITE, SMOOTH	ENTRY	F	*	ASSUMED	NF	30	SF
M-GRT-70	GROUT, GRAY, CEMENTITIOUS, ASSOCIATED WITH QUARRY/PAVER TILE, 8"X8", WHITE, SMOOTH	ENTRY	F	*	ASSUMED	NF	3	SF
M-VSF-71	VINYL SHEET FLOORING, BLUE, SMOOTH, WHITE MOTTLES, GRAY PAPER BACKING	KITCHEN	F	*	ASSUMED	NF	1,200	SF
		RESTROOM 1	F	*				
		RESTROOM 2	F	*				
M-MAS-72	MASTIC, YELLOW, TACKY, ASSOCIATED WITH VINYL SHEET FLOORING, BLUE, SMOOTH, WHITE MOTTLES, GRAY PAPER BACKING	KITCHEN	F	*	ASSUMED	NF	1,200	SF

JOB NAME: *Comprehensive AHERA Asbestos Inspection
Kyrene De La Esperanza Elementary School, KSD
Main Building*

JOB NO. 08-085

MATERIAL CODE	MATERIAL DESCRIPTION	MATERIAL LOCATION	MATERIAL COMPONENT	COMPONENT LOCATION	LAB ANALYSIS RESULTS	F/NF	MTL QUAN	UNITS
		RESTROOM 1	F	*				
		RESTROOM 2	F	*				
M-CPT-73	CARPET, BROWN, FIBROUS	BEDROOM 1	F	*	ASSUMED	NF	1,200	SF
		LIVING ROOM	F	*				
		BEDROOM 2	F	*				
M-MAS-74	MASTIC, YELLOW, TACKY, ASSOCIATED WITH CARPET, BROWN, FIBROUS	BEDROOM 1	F	*	ASSUMED	NF	1,200	SF
		LIVING ROOM	F	*				
		BEDROOM 2	F	*				
M-GWT-75	GLAZED WALL TILE, 4"X4", WHITE, SMOOTH	RESTROOM 1	W	N, W, S	ASSUMED	NF	60	SF
		RESTROOM 2	W	N, W, S				
M-GRT-76	GROUT, GRAY, CEMENTITIOUS, ASSOCIATED WITH GLAZED WALL TILE, 4"X4", WHITE, SMOOTH	RESTROOM 1	W	N, W, S	ASSUMED	NF	60	SF
		RESTROOM 2	W	N, W, S				
M-SLT-77	SEALANT (DOORS, WINDOWS, MILLWORK, FIXTURES), WHITE, PLIABLE	ENTRY	O	W	ASSUMED	NF	11	SF
		KITCHEN	O	N, E, W, S				
		BEDROOM 1	O	N, W				
		RESTROOM 1	O	E, W, S				
		RESTROOM 2	O	N, W				
		BEDROOM 2	O	N, S				
M-GRT-78	GROUT, GRAY, CEMENTITIOUS, ASSOCIATED WITH GLASS BLOCK, 4'X4", RIBBED	ENTRY	O	E	ASSUMED	NF	2	SF

END OF TABLE

JOB NAME: *Comprehensive AHERA Asbestos Inspection
Kyrene De La Esperanza Elementary School, KSD
Portable 71/72*

JOB NO. 08-085

**TABLE C
ASBESTOS CONTAINING BUILDING MATERIALS**

MATERIAL CODE	MATERIAL DESCRIPTION	MATERIAL LOCATION	MATERIAL COMPONENT	COMPONENT LOCATION	LAB ANALYSIS RESULTS	F/NF	MTL QUAN	UNITS
M-CMU-01	CONCRETE MASONRY UNIT, 8"X16", GRAY, CEMENTITIOUS, 8"X8" PATTERN	EXTERIOR	W	E, S	ASSUMED	NF	400	SF
M-MRT-02	MORTAR, GRAY, CEMENTITIOUS, ASSOCIATED WITH CONCRETE MASONRY UNIT, 8"X16", GRAY, CEMENTITIOUS, 8"X8" PATTERN	EXTERIOR	W	E, S	ASSUMED	NF	40	SF
M-CON-03	CONCRETE (ENTRIES), GRAY, CEMENTITIOUS	EXTERIOR	F	*	ASSUMED	NF	800	SF
M-BUR-04	BUILT-UP ROOFING, BLACK, ASPHALTIC, GRAY MINERAL CAP	ROOF	O	*	ASSUMED	NF	2,000	SF
M-MAS-05	MASTIC (PENETRATIONS AND FLASHINGS), BLACK, TAR-LIKE	ROOF	O	*	ASSUMED	NF	10	SF
M-SLT-06	SEALANT (WINDOWS), BLACK, PLIABLE	EXTERIOR	O	N	ASSUMED	NF	6	SF
M-SLT-07	SEALANT (DOORS, MILLWORK), WHITE, PLIABLE	P71	O	W	ASSUMED	NF	6	SF
		P72	O	E				
		EXTERIOR	O	N				
M-FDI-08	FIRE DOOR INSULATION, METAL CLADDING	P71	O	N	ASSUMED	NF	84	SF
		P72	O	N				
		EXTERIOR	O	N				
S-SAT-10	SPRAY-APPLIED TEXTURE, WHITE, CHALKY	P71	W	N, E, W, S	ASSUMED	NF	1,500	SF
		P72	W	N, E, W, S				
M-GWB-11	GYPHUM WALLBOARD, WHITE, CHALKY, ASSOCIATED WITH SPRAY-APPLIED TEXTURE, WHITE, CHALKY	P71	W	N, E, W, S	ASSUMED	NF	1,500	SF
		P72	W	N, E, W, S				
S-JTC-12	JOINT COMPOUND, WHITE, CHALKY, ASSOCIATED WITH GYPHUM WALLBOARD, WHITE, CHALKY	P71	W	N, E, W, S	ASSUMED	NF	150	SF
		P72	W	N, E, W, S				
M-TWP-13	TACKABLE WALL PANEL, BROWN, FIBROUS, VINYL COVER	P71	W	N, E, S	ASSUMED	NF	1,300	SF

JOB NAME: *Comprehensive AHERA Asbestos Inspection
Kyrene De La Esperanza Elementary School, KSD
Portable 71/72*

JOB NO. 08-085

MATERIAL CODE	MATERIAL DESCRIPTION	MATERIAL LOCATION	MATERIAL COMPONENT	COMPONENT LOCATION	LAB ANALYSIS RESULTS	F/NF	MTL QUAN	UNITS
		P72	W	N, W, S				
M-SAC-14	SINK ACOUSTICAL COATING, BLACK, ROUGH	P71	O	W	ASSUMED	NF	2	SF
		P72	O	E				
M-SAC-15	SINK ACOUSTICAL COATING, GRAY, ROUGH	P71	O	W	ASSUMED	NF	2	SF
		P72	O	E				
M-WAB-16	WALLBASE (COVERED), 4", BLACK, VINYL-LIKE	P71	O	N, E, W, S	ASSUMED	NF	60	SF
		P72	O	N, E, W, S				
M-ADH-17	ADHESIVE, CREAM, PLIABLE, ASSOCIATED WITH WALLBASE (COVERED), 4", BLACK, VINYL-LIKE	P71	O	N, E, W, S	ASSUMED	NF	60	SF
		P72	O	N, E, W, S				
M-CPT-18	CARPET, BLUE, FIBROUS, MULTI-COLORED	P71	F	*	ASSUMED	NF	2,000	SF
		P72	F	*				
M-MAS-19	MASTIC, YELLOW, TACKY, ASSOCIATED WITH CARPET, BLUE, FIBROUS, MULTI-COLORED	P71	F	*	ASSUMED	NF	2,000	SF
		P72	F	*				
M-DST-20	DUCT SEAM TAPE, 4", WHITE, CANVAS-LIKE	P71	O	*	ASSUMED	F	10	SF
		P72	O	*				

END OF TABLE

JOB NAME: *Comprehensive AHERA Asbestos Inspection
Kyrene De La Esperanza Elementary School, KSD
Portable 73/74*

JOB NO. 08-085

**TABLE C
ASBESTOS CONTAINING BUILDING MATERIALS**

MATERIAL CODE	MATERIAL DESCRIPTION	MATERIAL LOCATION	MATERIAL COMPONENT	COMPONENT LOCATION	LAB ANALYSIS RESULTS	F/NF	MTL QUAN	UNITS
M-CMU-01	CONCRETE MASONRY UNIT, 8"X16", GRAY, CEMENTITIOUS	EXTERIOR	W	W, S	ASSUMED	NF	400	SF
M-MRT-02	MORTAR, GRAY, CEMENTITIOUS, ASSOCIATED WITH CONCRETE MASONRY UNIT, 8"X16", GRAY, CEMENTITIOUS	EXTERIOR	W	W, S	ASSUMED	NF	40	SF
M-CON-03	CONCRETE (ENTRIES), GRAY, CEMENTITIOUS	EXTERIOR	F	*	ASSUMED	NF	800	SF
M-BUR-04	BUILT-UP ROOFING, BLACK, ASPHALTIC, GRAY MINERAL CAP	ROOF	O	*	ASSUMED	NF	2,000	SF
M-MAS-05	MASTIC (PENETRATIONS AND FLASHINGS), BLACK, TAR-LIKE	ROOF	O	*	ASSUMED	NF	10	SF
M-SLT-06	SEALANT (WINDOWS), BLACK, PLIABLE	EXTERIOR	O	N	ASSUMED	NF	6	SF
M-SLT-07	SEALANT (DOORS, WINDOWS), WHITE, PLIABLE	P73	O	W	ASSUMED	NF	6	SF
		P74	O	E				
		EXTERIOR	O	N				
M-FDI-08	FIRE DOOR INSULATION, METAL CLADDING	P73	O	N	ASSUMED	NF	84	SF
		P74	O	N				
		EXTERIOR	O	N				
S-SAT-10	SPRAY-APPLIED TEXTURE, WHITE, CHALKY	P73	W	N, E, W, S	ASSUMED	NF	1,500	SF
		P74	W	N, E, W, S				
M-GWB-11	GYPSUM WALLBOARD, WHITE, CHALKY, ASSOCIATED WITH SPRAY-APPLIED TEXTURE, WHITE, CHALKY	P73	W	N, E, W, S	ASSUMED	NF	1,500	SF
		P74	W	N, E, W, S				
S-JTC-12	JOINT COMPOUND, WHITE, CHALKY, ASSOCIATED WITH GYPSUM WALLBOARD, WHITE, CHALKY	P73	W	N, E, W, S	ASSUMED	NF	150	SF
		P74	W	N, E, W, S				
M-TWP-13	TACKABLE WALL PANEL, BROWN, FIBROUS, GRAY VINYL COVER	P73	W	N, E, S	ASSUMED	NF	1,300	SF
		P74	W	N, W, S				

JOB NAME: *Comprehensive AHERA Asbestos Inspection
Kyrene De La Esperanza Elementary School, KSD
Portable 73/74*

JOB NO. 08-085

MATERIAL CODE	MATERIAL DESCRIPTION	MATERIAL LOCATION	MATERIAL COMPONENT	COMPONENT LOCATION	LAB ANALYSIS RESULTS	F/NF	MTL QUAN	UNITS
M·SAC·14	SINK ACOUSTICAL COATING, BLACK, ROUGH	P73	O	W	ASSUMED	NF	2	SF
		P74	O	E				
M·WAB·16	WALLBASE (COVERED), 4", BLACK, VINYL-LIKE	P73	O	N, E, W, S	ASSUMED	NF	60	SF
		P74	O	N, E, W, S				
M·ADH·17	ADHESIVE, CREAM, PLIABLE, ASSOCIATED WITH WALLBASE (COVERED), 4", BLACK, VINYL-LIKE	P73	O	N, E, W, S	ASSUMED	NF	60	SF
		P74	O	N, E, W, S				
M·CPT·18	CARPET, BLUE, FIBROUS, MULTI-COLORED	P73	F	*	ASSUMED	NF	1,500	SF
		P74	F	*				
M·MAS·19	MASTIC, YELLOW, TACKY, ASSOCIATED WITH CARPET, BLUE, FIBROUS, MULTI-COLORED	P73	F	*	ASSUMED	NF	1,500	SF
		P74	F	*				
M·DST·20	DUCT SEAM TAPE, 4", WHITE, CANVAS-LIKE	P73	O	*	ASSUMED	F	10	SF
		P74	O	*				
M·VCT·21	VINYL COMPOSITION TILE, 12"X12", OFF-WHITE, SMOOTH, WHITE MOTTLES	P73	F	*	ASSUMED	NF	250	SF
		P74	F	*				
M·VCT·22	VINYL COMPOSITION TILE, 12"X12", TAN, SMOOTH, TAN MOTTLES	P73	F	*	ASSUMED	NF	250	SF
		P74	F	*				
M·MAS·23	MASTIC, YELLOW, TACKY, ASSOCIATED WITH VINYL COMPOSITION TILE, 12"X12", OFF-WHITE, SMOOTH, WHITE MOTTLES AND VINYL COMPOSITION TILE, 12"X12", TAN, SMOOTH, TAN MOTTLES	P73	F	*	ASSUMED	NF	500	SF
		P74	F	*				

END OF TABLE

ACM/ACBM LOCATION PLANS

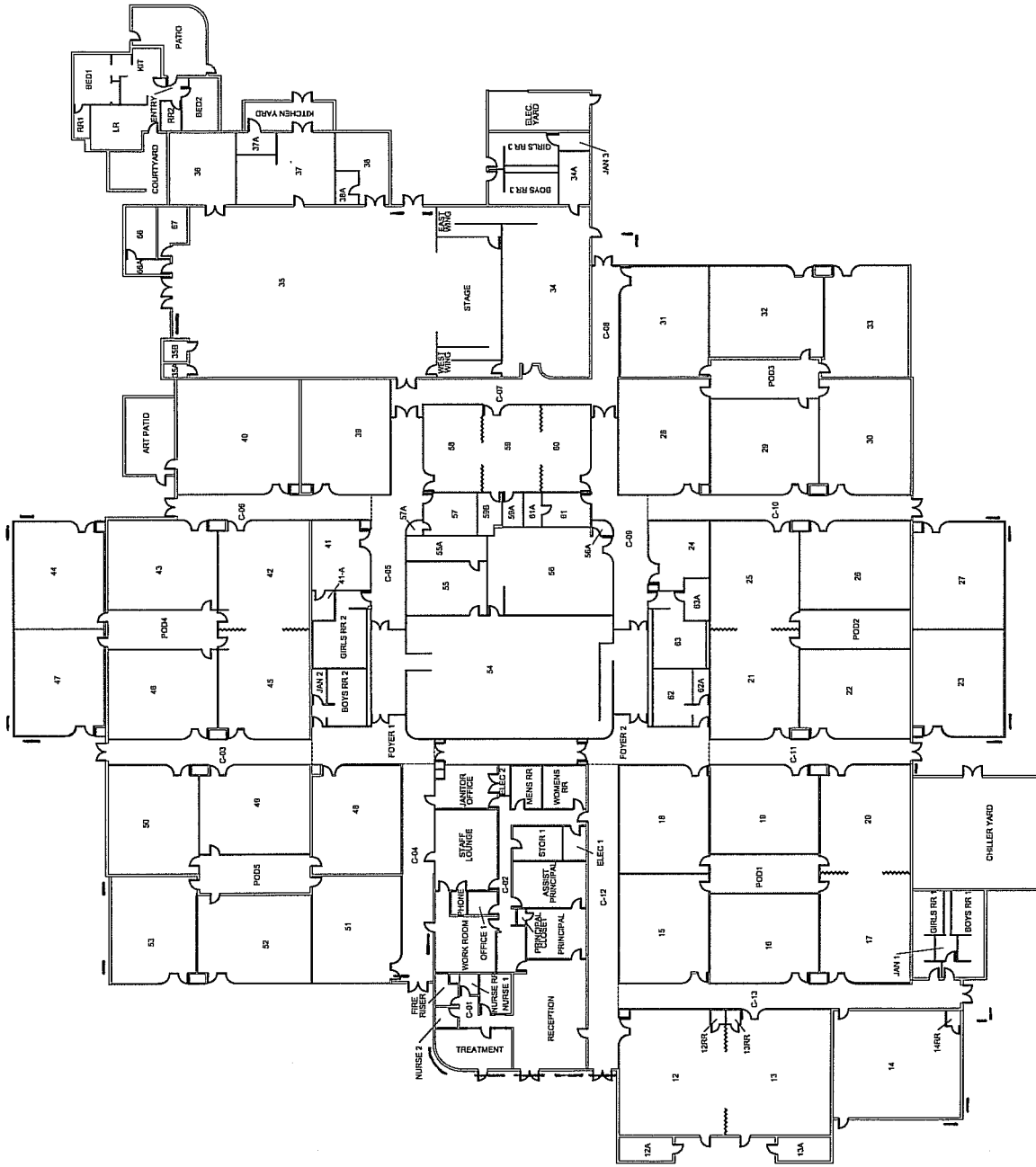

FLOOR PLAN
N.T.S.



FM GROUP INC
15974 N. 77TH STREET
SUITE 100
SCOTTSDALE, AZ 85260
Phone: (602) 277-7877
Fax: (602) 277-8288

PROJ. NO: 08-085
DATE: 03.05.08
DRAWN BY: JGA
CHECKED BY: CR

PROJECT: AHERA ASBESTOS INSPECTION
CLIENT: KYRENE SCHOOL DISTRICT NO. 28
SITE: KYRENE DE LA ESPERANZA ELEMENTARY SCHOOL
BUILDING: MAIN BUILDING M-OPT-07

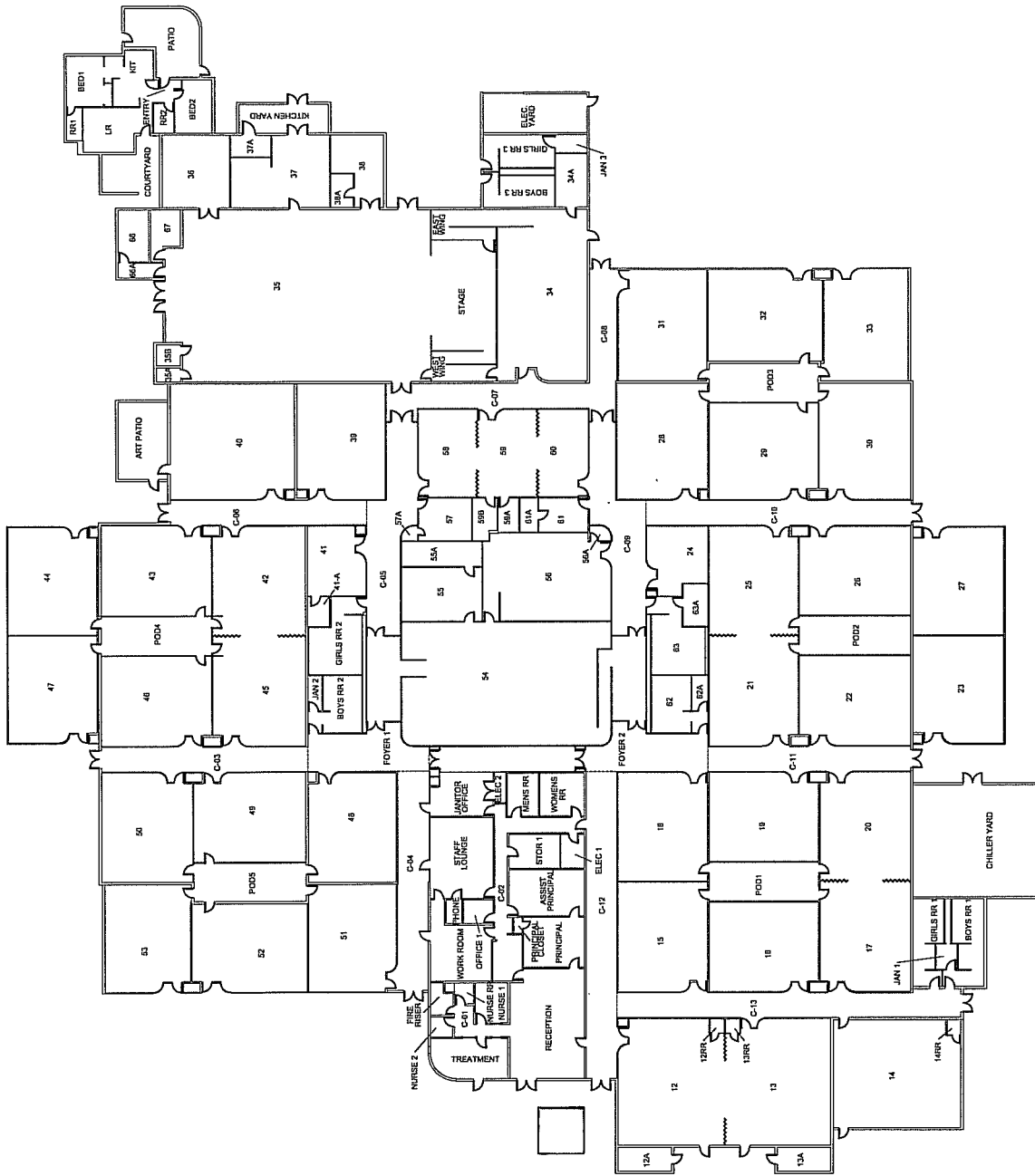

FLOOR PLAN
N.T.S.

NORTH

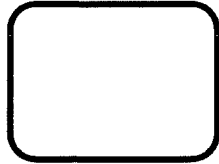

FM GROUP INC
15974 N. 77TH STREET
SUITE 100
SCOTTSDALE, AZ 85260
Phone: (602) 277-7877
Fax: (602) 277-8288

PROJ. NO: 08-085
DATE: 03.05.08
DRAWN BY: JCA
CHECKED BY: CR

PROJECT: AHERA ASBESTOS INSPECTION

CLIENT: KYRENE SCHOOL DISTRICT NO. 28

SITE: KYRENE DE LA ESPERANZA ELEMENTARY SCHOOL

BUILDING: MAIN BUILDING

M-GWT-10
M-GRT-11

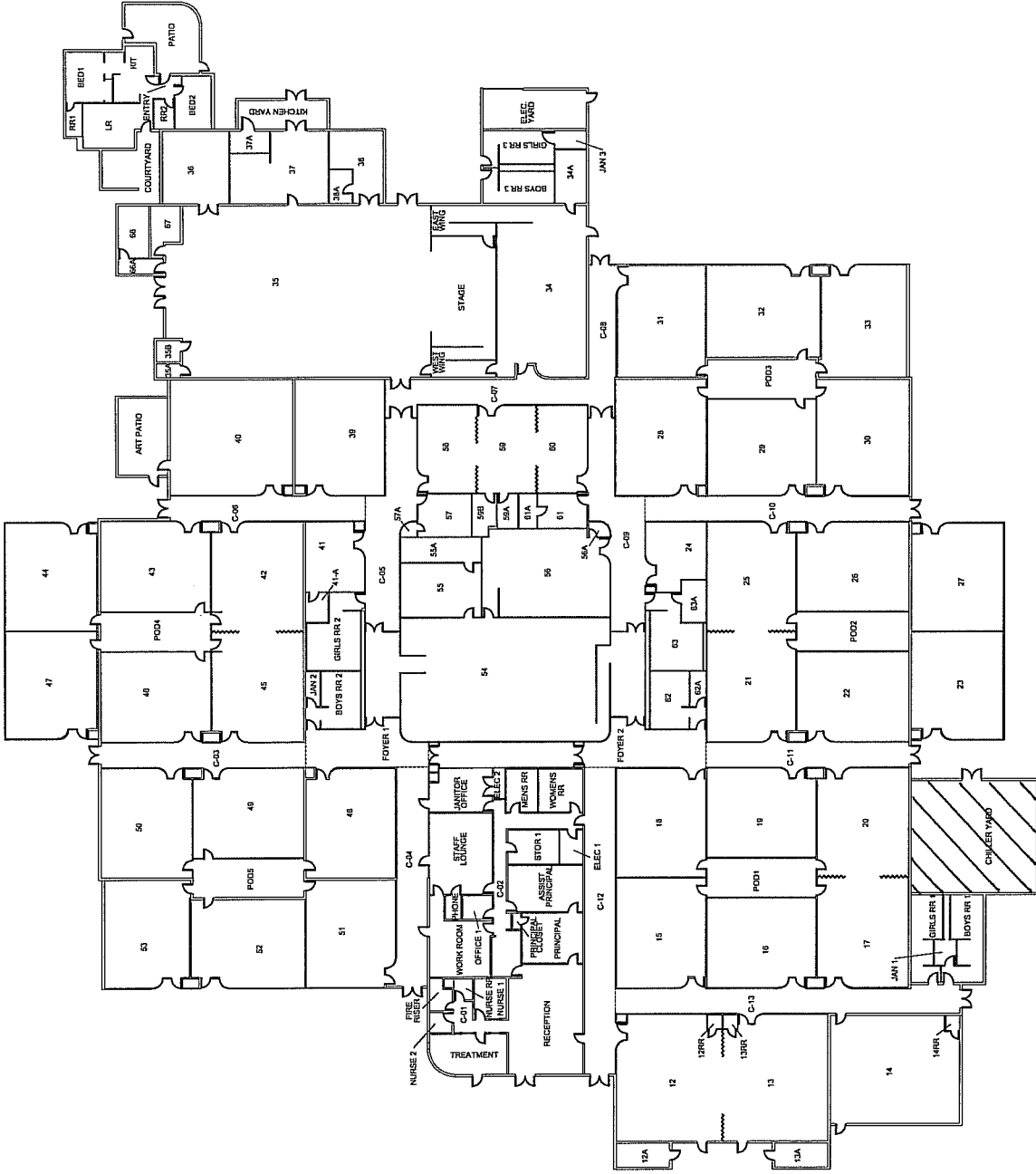

FLOOR PLAN
N.T.S.

NORTH

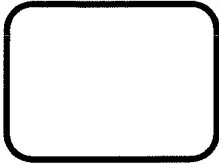

FM GROUP INC
15974 N. 77TH STREET
SUITE 100
SCOTTSDALE, AZ 85260
Phone: (602) 277-7877
Fax: (602) 277-8288

PROJ. NO: 08-085
DATE: 03.05.08
DRAWN BY: JGA
CHECKED BY: CR

PROJECT: AHERA ASBESTOS INSPECTION
CLIENT: KYRENE SCHOOL DISTRICT NO. 28
SITE: KYRENE DE LA ESPERANZA ELEMENTARY SCHOOL
BUILDING: MAIN BUILDING M-CON-14

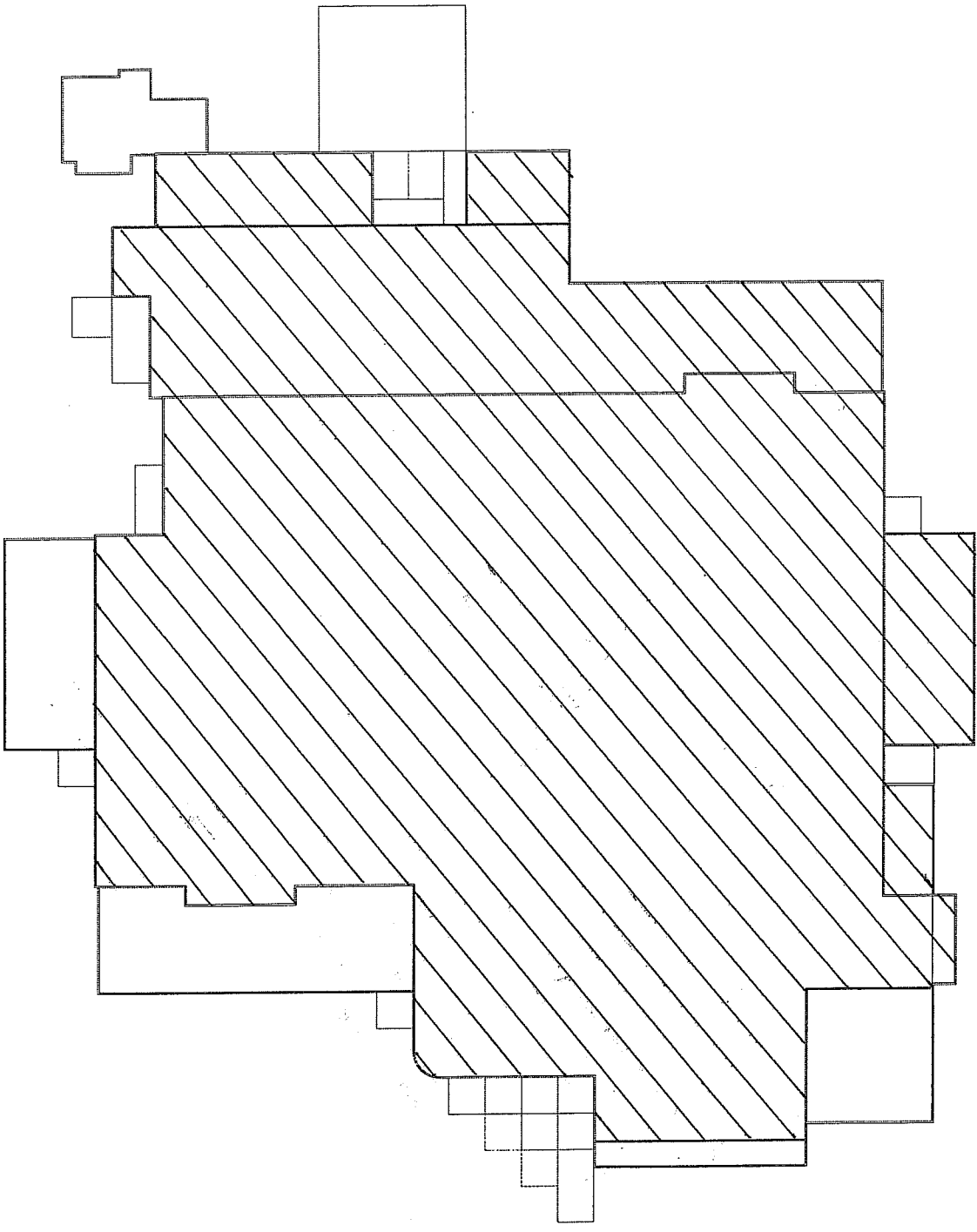

ROOF PLAN
N.T.S.



PROJECT: AMERA ASBESTOS INSPECTION

CLIENT: KYRENE SCHOOL DISTRICT NO. 28
 SITE: KYRENE DE LA ESPERANZA ELEMENTARY SCHOOL
 BUILDING: MAIN BUILDING

PROJ. NO: 08-085
 DATE: 03.05.08
 DRAWN BY: JGA
 CHECKED BY: CR

FM GROUP INC

FM GROUP INC
 15974 N. 77TH STREET
 SUITE 100
 SCOTTSDALE, AZ 85260
 Phone: (602) 277-7877
 Fax: (602) 277-8288

PROJECT: AMERA ASBESTOS INSPECTION

CLIENT: KYRENE SCHOOL DISTRICT NO. 28

SITE: KYRENE DE LA ESPERANZA ELEMENTARY SCHOOL

BUILDING: MAIN BUILDING

PROJ. NO: 08-085

DATE: 03.05.08

DRAWN BY: JGA

CHECKED BY: CR

FM GROUP INC

FM GROUP INC
 15974 N. 77TH STREET
 SUITE 100
 SCOTTSDALE, AZ 85260
 Phone: (602) 277-7877
 Fax: (602) 277-8288

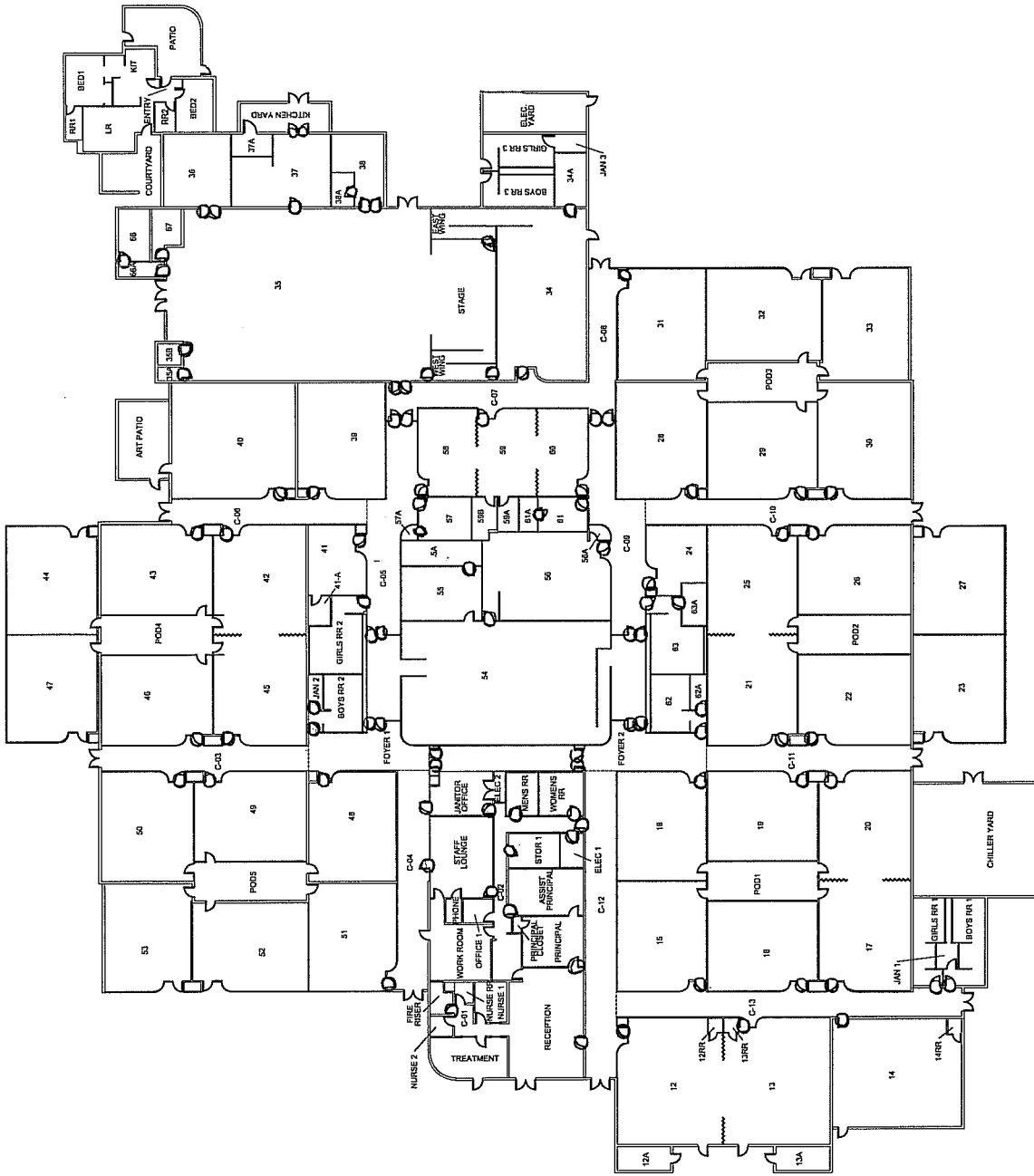

FLOOR PLAN
N.T.S.



FM GROUP INC
15974 N. 77TH STREET
SUITE 100
SCOTTSDALE, AZ 85260
Phone: (602) 277-7877
Fax: (602) 277-8288

PROJ. NO: 08-085
DATE: 03.05.08
DRAWN BY: JGA
CHECKED BY: CR

PROJECT: AHERA ASBESTOS INSPECTION
CLIENT: KYRENE SCHOOL DISTRICT NO. 28
SITE: KYRENE DE LA ESPERANZA ELEMENTARY SCHOOL
BUILDING: MAIN BUILDING M-F-1-27

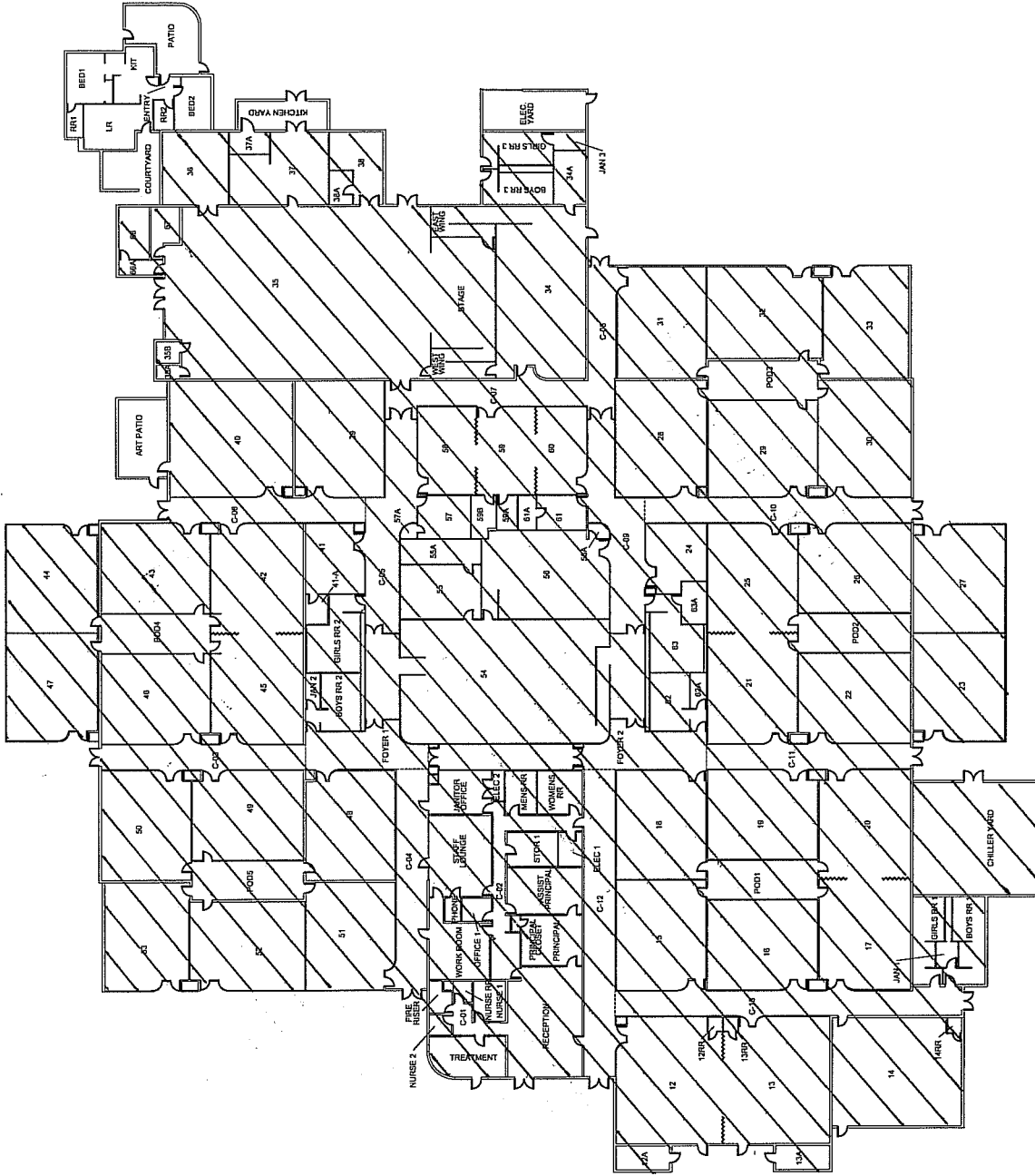

FLOOR PLAN
N.T.S.



PROJECT: AHERA ASBESTOS INSPECTION

CLIENT: KYRENE SCHOOL DISTRICT NO. 28

SITE: KYRENE DE LA ESPERANZA ELEMENTARY SCHOOL

BUILDING: MAIN BUILDING

M. PSL-28

PROJ. NO: 08-085

DATE: 03.05.08

DRAWN BY: JGA

CHECKED BY: CR



FM GROUP INC
15974 N. 77TH STREET
SUITE 100
SCOTTSDALE, AZ 85260

Phone: (602) 277-7877
Fax: (602) 277-8288

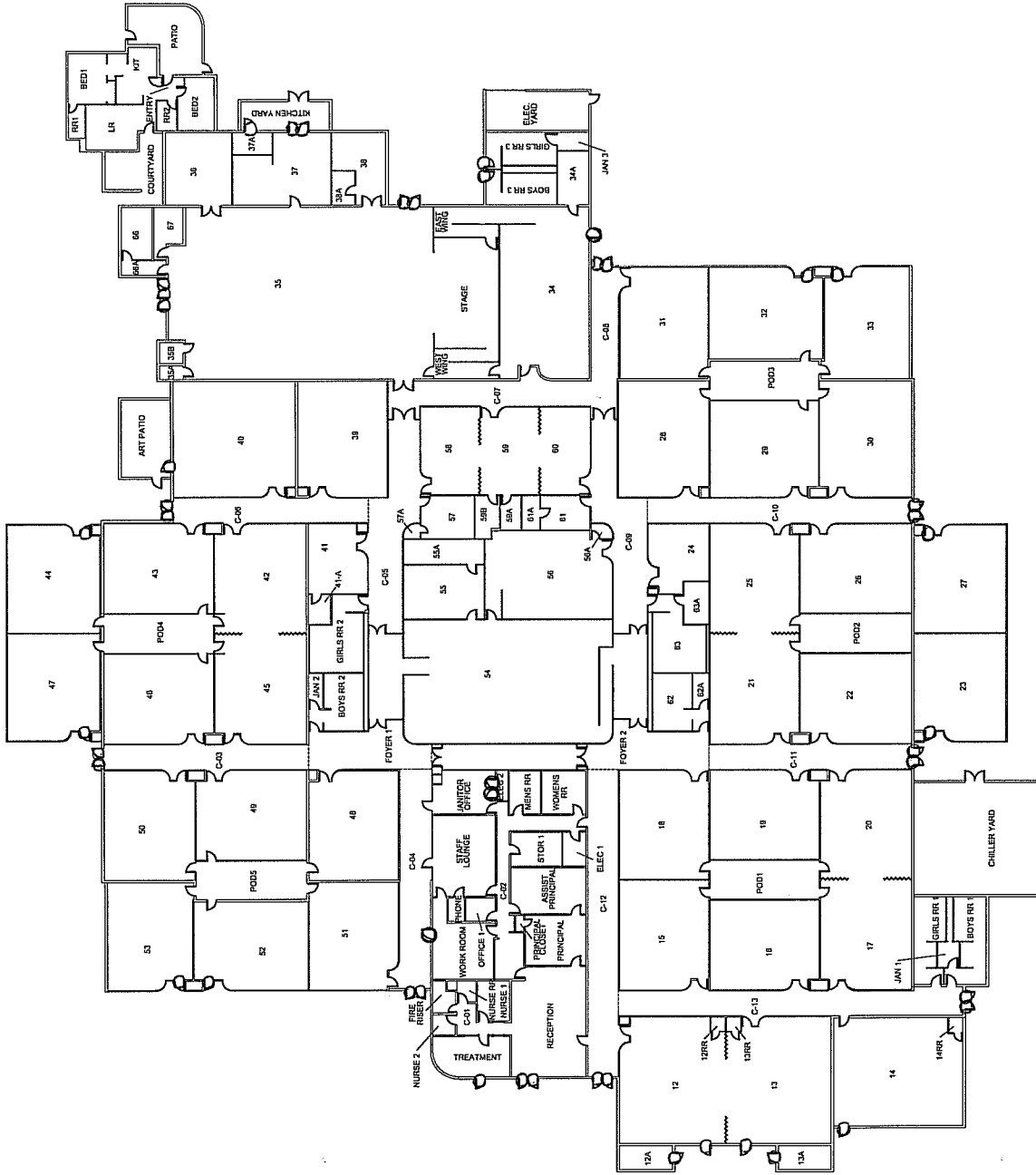

FLOOR PLAN
N.T.S.



PROJECT: AHERA ASBESTOS INSPECTION

CLIENT: KYRENE SCHOOL DISTRICT NO. 28

SITE: KYRENE DE LA ESPERANZA ELEMENTARY SCHOOL

BUILDING: MAIN BUILDING

M.F.D. - 44

PROJ. NO: 08-085

DATE: 03.05.08

DRAWN BY: JGA

CHECKED BY: CR



FM GROUP INC
15974 N. 77TH STREET
SUITE 100
SCOTTSDALE, AZ 85260
Phone: (602) 277-7877
Fax: (602) 277-8288

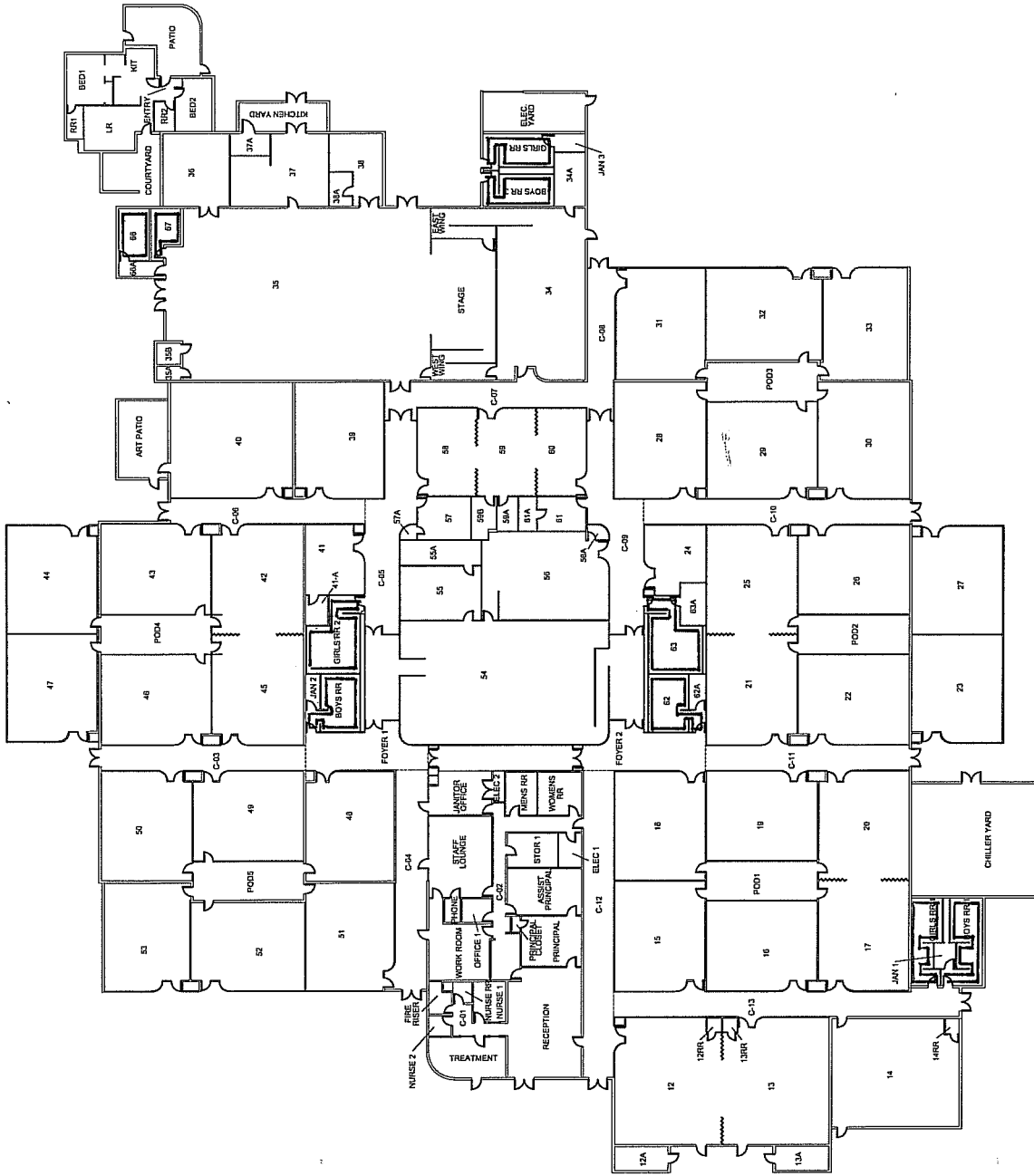

FLOOR PLAN
N.T.S.



PROJECT: AHERA ASBESTOS INSPECTION

CLIENT: KYRENE SCHOOL DISTRICT NO. 28
 SITE: KYRENE DE LA ESPERANZA ELEMENTARY SCHOOL
 BUILDING: MAIN BUILDING

M. GURT-51
M. GURT-52
M. GURT-53

PROJ. NO: 06-085
 DATE: 03.05.08
 DRAWN BY: JGA
 CHECKED BY: CR



FM GROUP INC
 15974 N. 77TH STREET
 SUITE 100
 SCOTTSDALE, AZ 85260
 Phone: (602) 277-7877
 Fax: (602) 277-8288

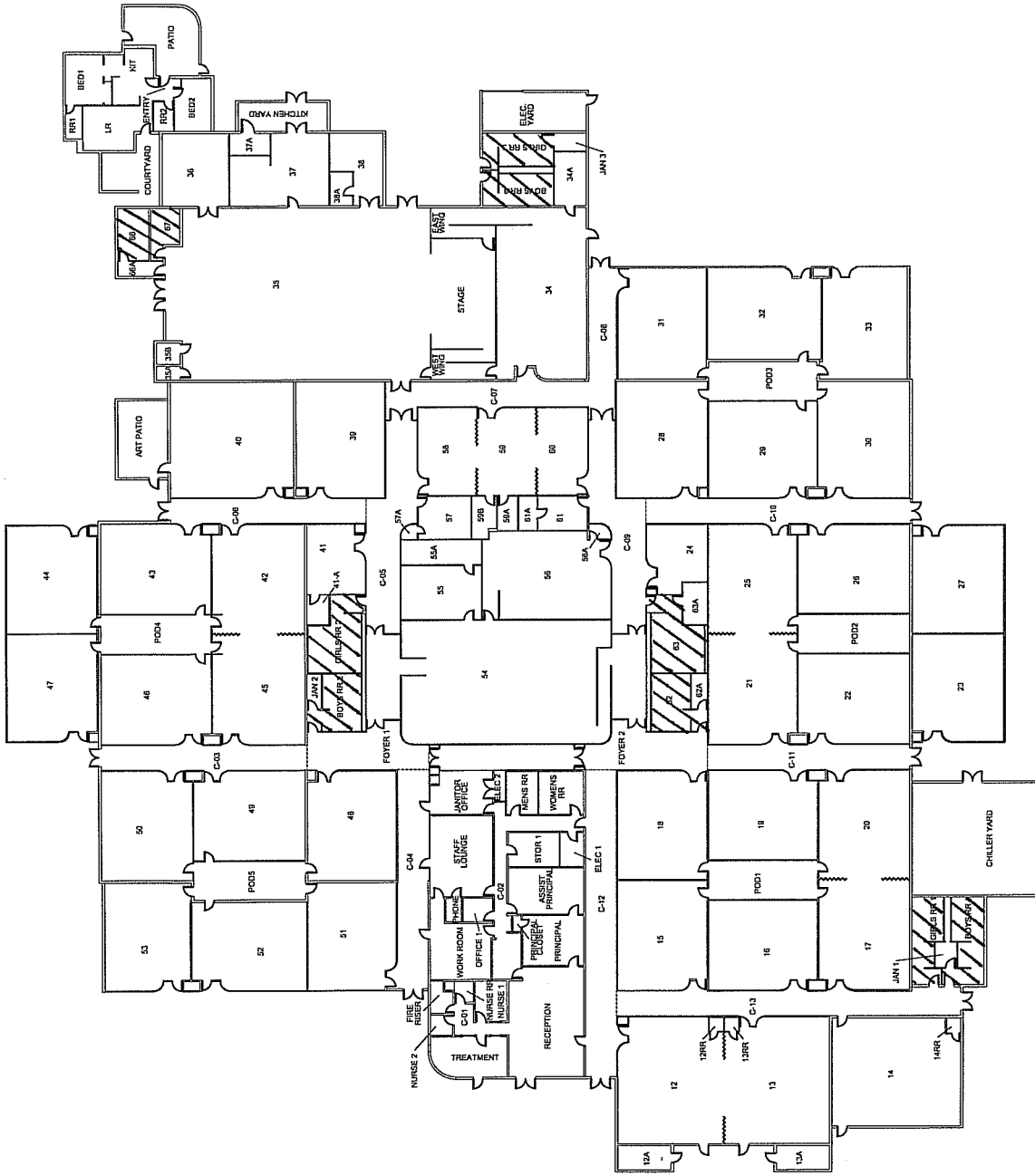

FLOOR PLAN
N.T.S.

PROJECT: **AHERA ASBESTOS INSPECTION**

CLIENT: KYRENE SCHOOL DISTRICT NO. 28
 SITE: KYRENE DE LA ESPERANZA ELEMENTARY SCHOOL
 BUILDING: MAIN BUILDING



PROJ. NO: 06-085
 DATE: 03.05.08
 DRAWN BY: JGA
 CHECKED BY: CR

FM GROUP INC
 15974 N. 77TH STREET
 SUITE 100
 SCOTTSDALE, AZ 85260
 Phone: (602) 277-7877
 Fax: (602) 277-8288

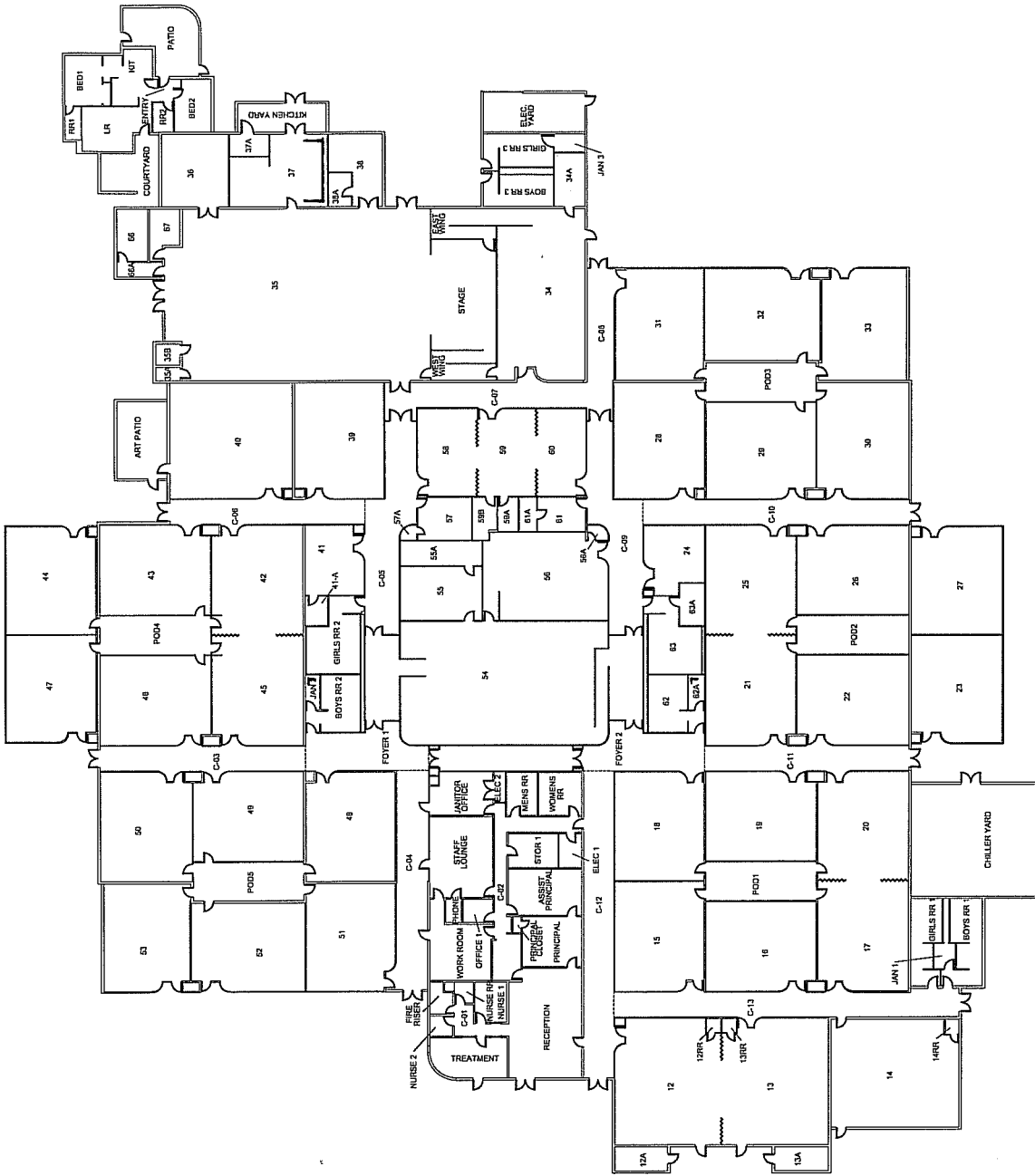

FLOOR PLAN
N.T.S. NORTH

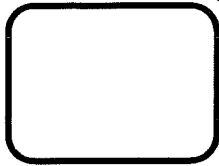

FM GROUP INC
15974 N. 77TH STREET
SUITE 100
SCOTTSDALE, AZ 85260
Phone: (602) 277-7877
Fax: (602) 277-8288

PROJ. NO: 08-085
DATE: 03.05.08
DRAWN BY: JGA
CHECKED BY: CR

PROJECT: AHERA ASBESTOS INSPECTION

CLIENT: KYRENE SCHOOL DISTRICT NO. 28
SITE: KYRENE DE LA ESPERANZA ELEMENTARY SCHOOL
BUILDING: MAIN BUILDING

M. ADH. 510

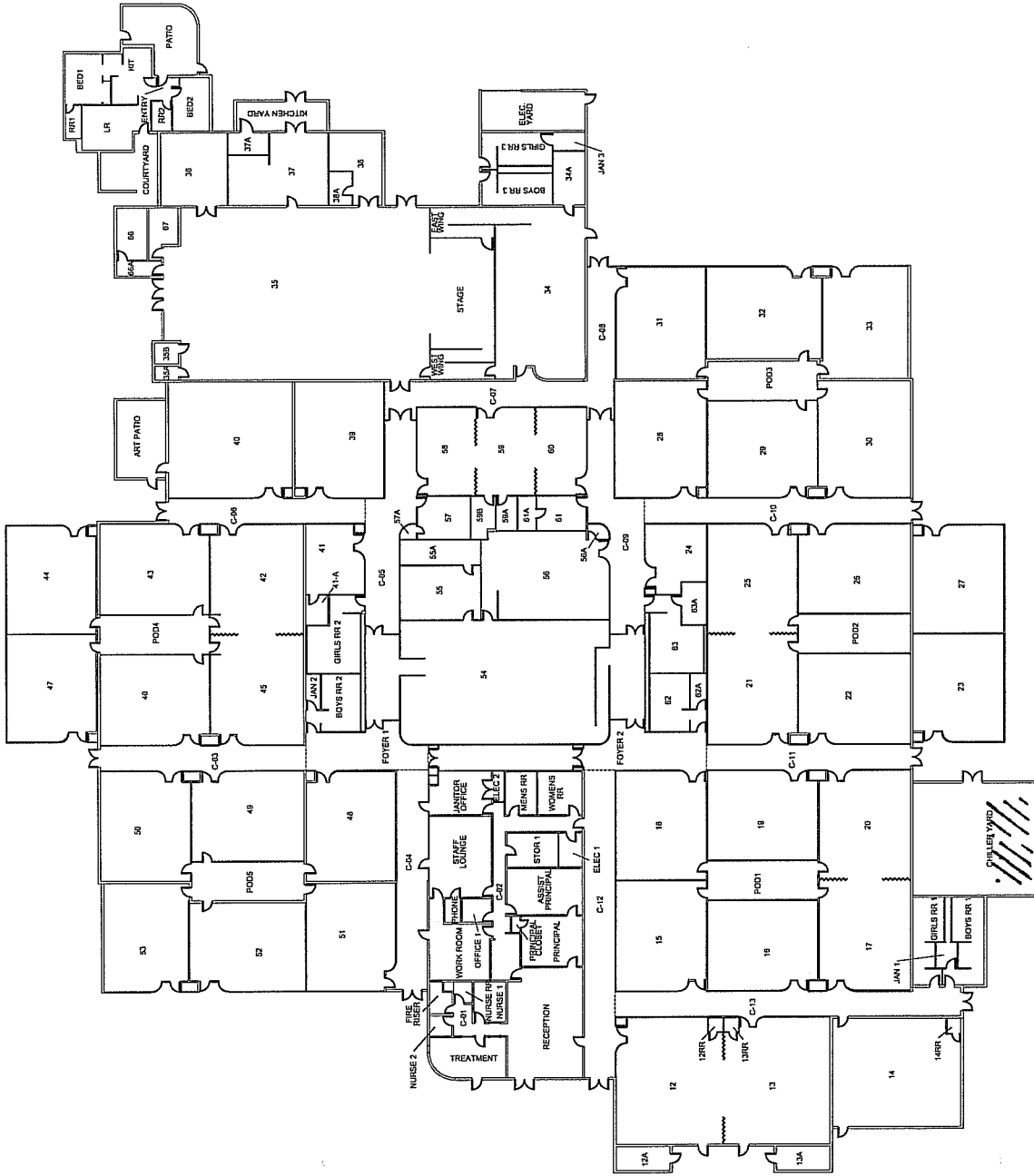

FLOOR PLAN
N.T.S. NORTH

PROJECT: **AHERA ASBESTOS INSPECTION**

CLIENT: KYRENE SCHOOL DISTRICT NO. 28
 SITE: KYRENE DE LA ESPERANZA ELEMENTARY SCHOOL
 BUILDING: MAIN BUILDING



PROJ. NO: 08-085
 DATE: 03.05.08
 DRAWN BY: JGA
 CHECKED BY: CR

M. PSL-57

FM GROUP INC
 15974 N. 77TH STREET
 SUITE 100
 SCOTTSDALE, AZ 85260
 Phone: (602) 277-7877
 Fax: (602) 277-8288

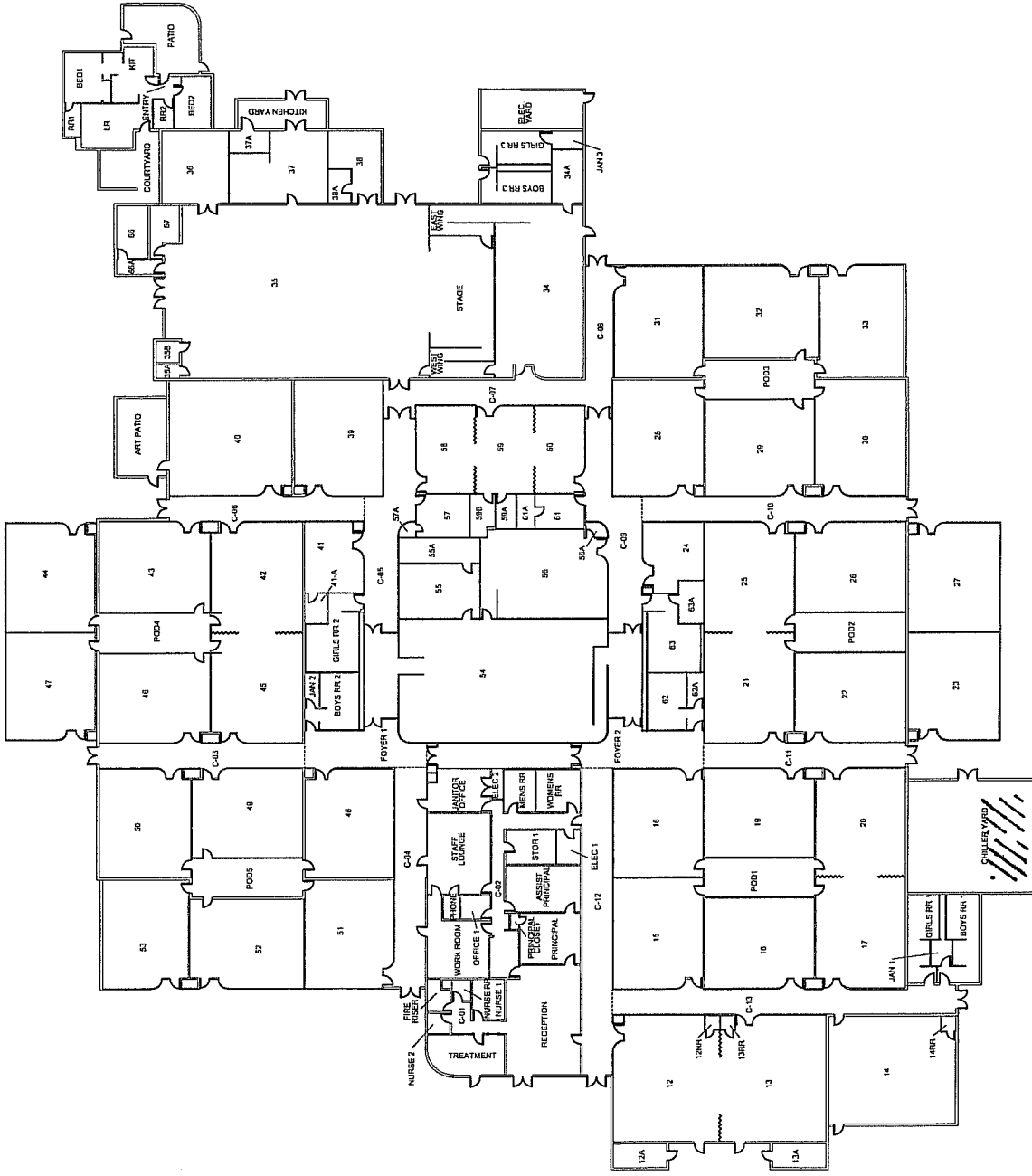

FLOOR PLAN
N.T.S.

NORTH

PROJECT: AHERA ASBESTOS INSPECTION

CLIENT: KYRENE SCHOOL DISTRICT NO. 28

SITE: KYRENE DE LA ESPERANZA ELEMENTARY SCHOOL

BUILDING: MAIN BUILDING

PROJ. NO: 08-085

DATE: 03.05.08

DRAWN BY: JGA

CHECKED BY: CR

FM GROUP INC

15974 N. 77TH STREET
SUITE 100
SCOTTSDALE, AZ 85260

Phone: (602) 277-7877
Fax: (602) 277-8288

M-5LT-58

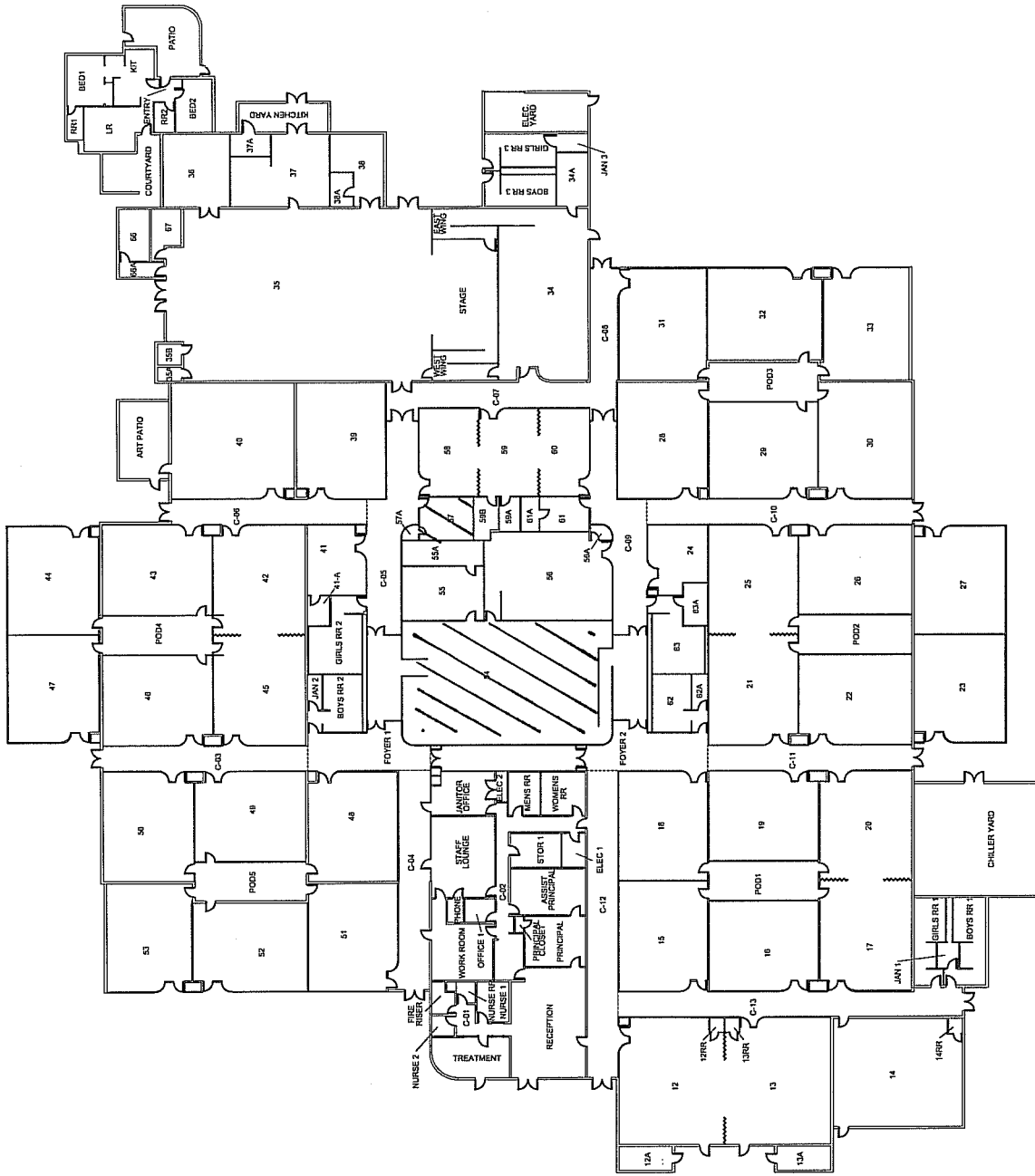

FLOOR PLAN
N.T.S.

NORTH



FM GROUP INC
15974 N. 77TH STREET
SUITE 100
SCOTTSDALE, AZ 85260
Phone: (602) 277-7877
Fax: (602) 277-8288

PROJ. NO: 08-085
DATE: 03.05.08
DRAWN BY: JGA
CHECKED BY: CR

PROJECT: AHERA ASBESTOS INSPECTION

CLIENT: KYRENE SCHOOL DISTRICT NO. 28

SITE: KYRENE DE LA ESPERANZA ELEMENTARY SCHOOL

BUILDING: MAIN BUILDING *M. APL-59*

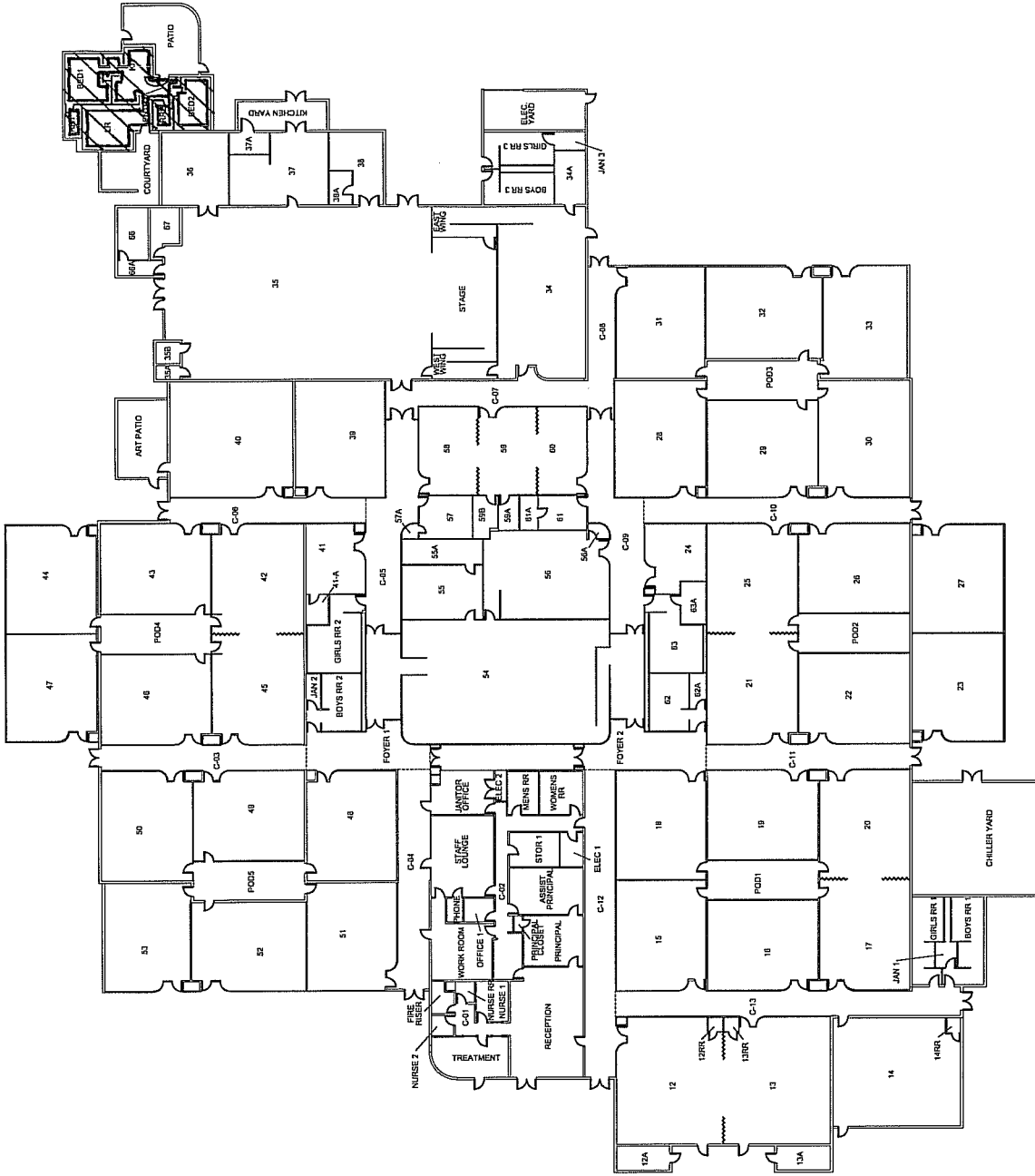

FLOOR PLAN
N.T.S. NORTH

PROJECT: AHERA ASBESTOS INSPECTION

CLIENT: KYRENE SCHOOL DISTRICT NO. 28

SITE: KYRENE DE LA ESPERANZA ELEMENTARY SCHOOL

BUILDING: MAIN BUILDING

S.S.A.T. 606

M.G.W.B. 607

S.A.T.C. 608

PROJ. NO: 08-085

DATE: 03.05.08

DRAWN BY: JGA

CHECKED BY: CR

FM GROUP INC
15974 N. 77TH STREET
SUITE 100
SCOTTSDALE, AZ 85260
Phone: (602) 277-7877
Fax: (602) 277-8288



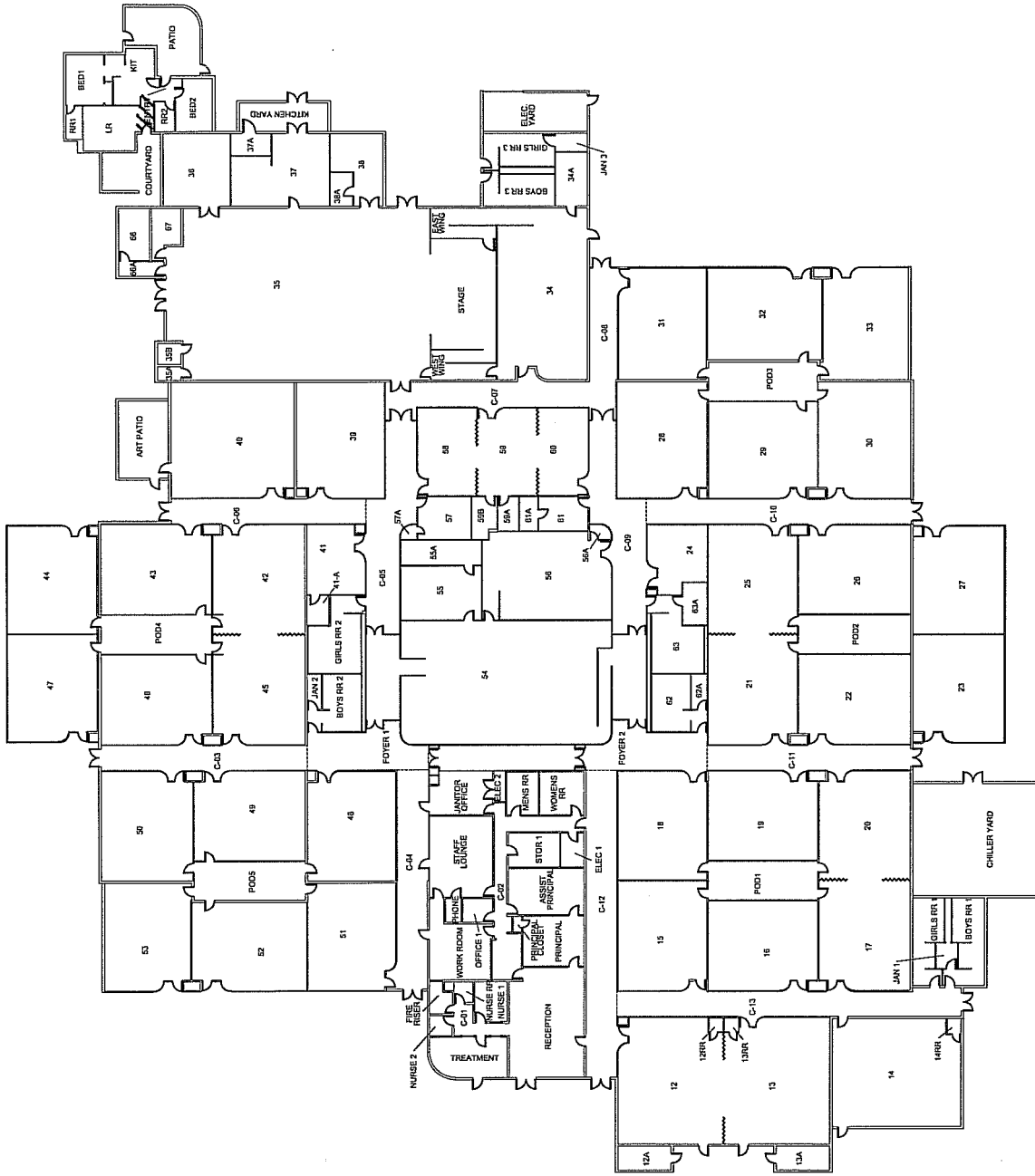

FLOOR PLAN
N.T.S.



FM GROUP INC
15974 N. 77TH STREET
SUITE 100
SCOTTSDALE, AZ 85260
Phone: (602) 277-7877
Fax: (602) 277-8288

PROJ. NO: 08-085
DATE: 03.05.08
DRAWN BY: JGA
CHECKED BY: CR

PROJECT: **AHERA ASBESTOS INSPECTION**
CLIENT: KYRENE SCHOOL DISTRICT NO. 28
SITE: KYRENE DE LA ESPERANZA ELEMENTARY SCHOOL
BUILDING: MAIN BUILDING

M.G.P.T. 09
M.G.P.T. 10

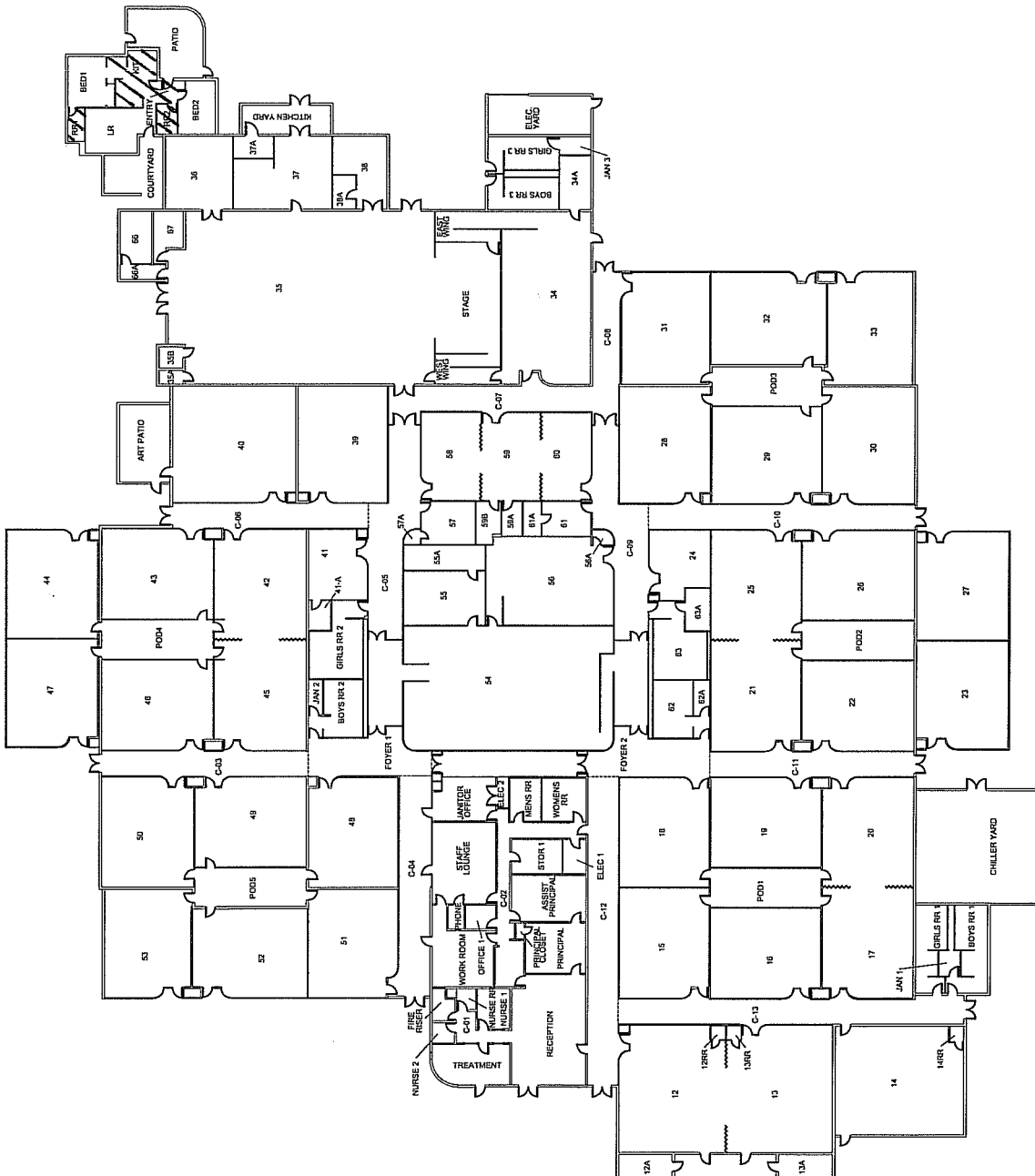

FLOOR PLAN
N.T.S. NORTH

PROJECT: **AHERA ASBESTOS INSPECTION**

CLIENT: KYRENE SCHOOL DISTRICT NO. 28

SITE: KYRENE DE LA ESPERANZA ELEMENTARY SCHOOL

BUILDING: MAIN BUILDING

PROJ. NO: 08-085

DATE: 03.05.08

DRAWN BY: JGA

CHECKED BY: CR

FM GROUP INC
15974 N. 77TH STREET
SUITE 100
SCOTTSDALE, AZ 85260
Phone: (602) 277-7877
Fax: (602) 277-8288

FM GROUP INC

PROJ. NO: 08-085

DATE: 03.05.08

DRAWN BY: JGA

CHECKED BY: CR

CLIENT: KYRENE SCHOOL DISTRICT NO. 28

SITE: KYRENE DE LA ESPERANZA ELEMENTARY SCHOOL

BUILDING: MAIN BUILDING

M: 557-71
M: 557-72

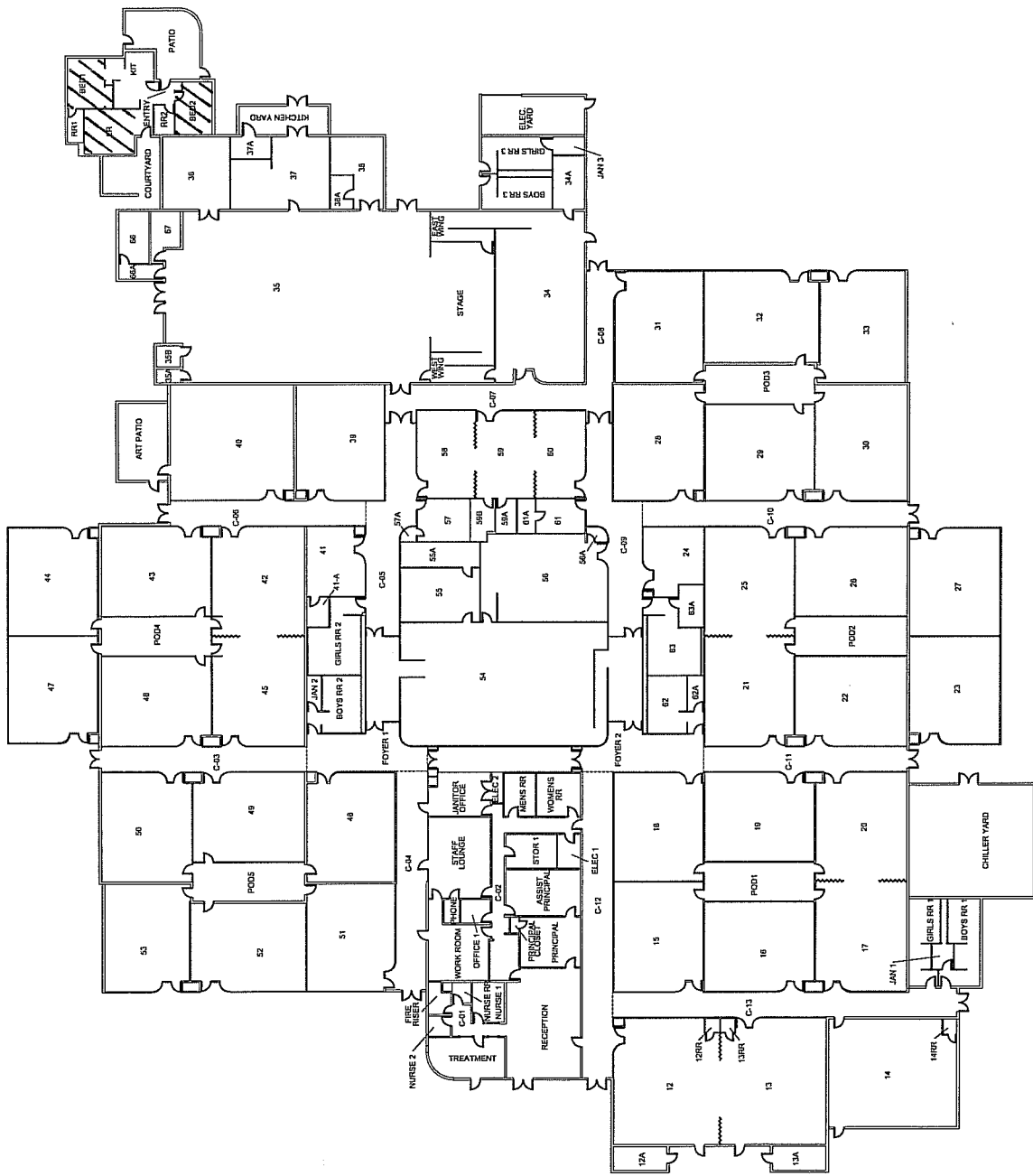

FLOOR PLAN

N.T.S. NORTH

PROJECT: AHERA ASBESTOS INSPECTION

CLIENT: KYRENE SCHOOL DISTRICT NO. 28

SITE: KYRENE DE LA ESPERANZA ELEMENTARY SCHOOL

BUILDING: MAIN BUILDING

M. CAP. 73
M. MAAS-74

PROJ. NO: 08-085

DATE: 03.05.08

DRAWN BY: JGA

CHECKED BY: CR



FM GROUP INC
15974 N. 77TH STREET
SUITE 100
SCOTTSDALE, AZ 85260
Phone: (602) 277-7877
Fax: (602) 277-8288

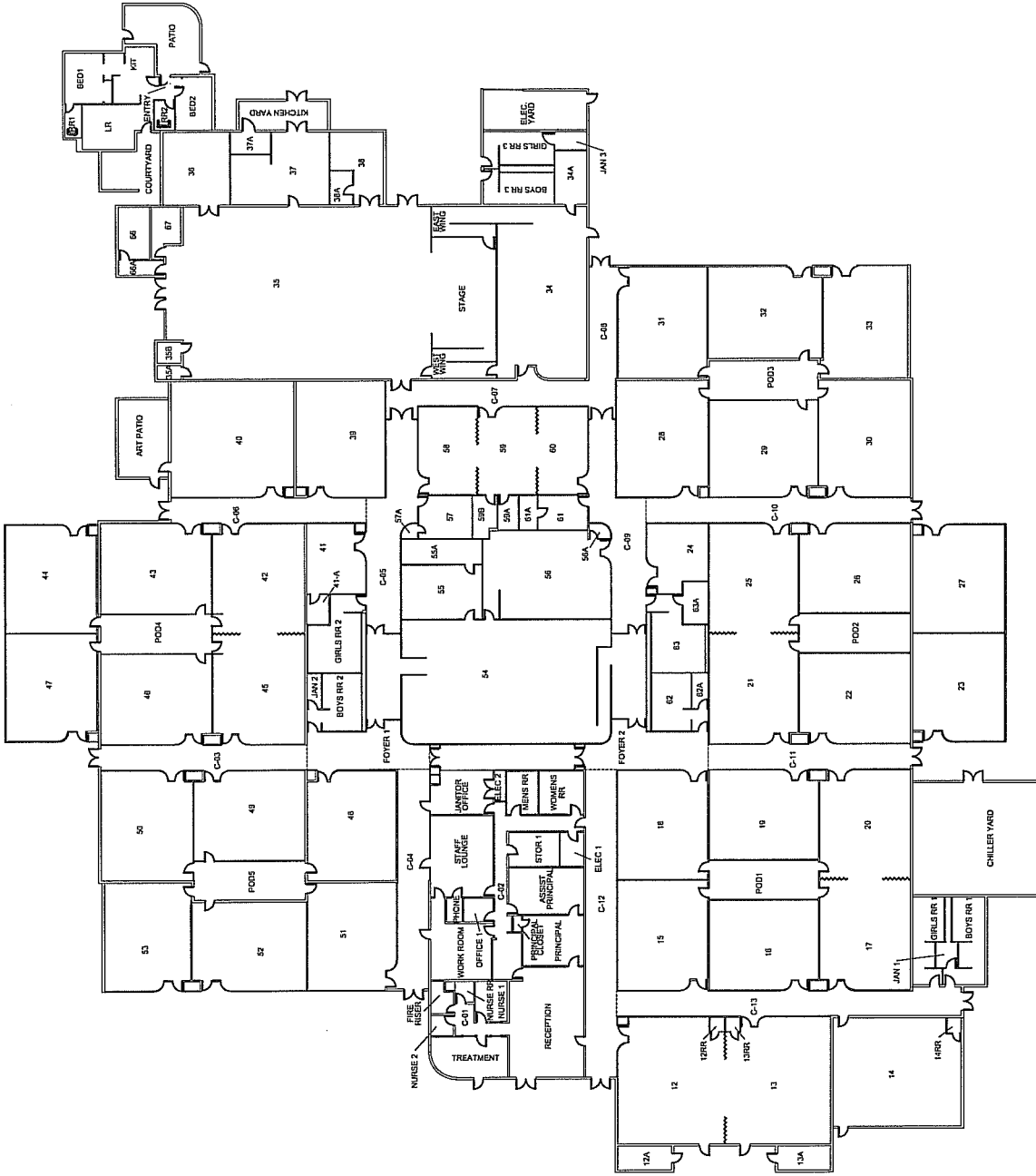

FLOOR PLAN
N.T.S. NORTH

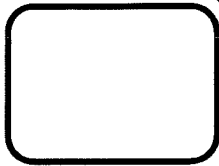

FM GROUP INC
15974 N. 77TH STREET
SUITE 100
SCOTTSDALE, AZ 85280
Phone: (602) 277-7877
Fax: (602) 277-8288

PROJ. NO: 06-085
DATE: 03.05.08
DRAWN BY: JGA
CHECKED BY: CR

PROJECT: **AHERA ASBESTOS INSPECTION**
CLIENT: KYRENE SCHOOL DISTRICT NO. 28
SITE: KYRENE DE LA ESPERANZA ELEMENTARY SCHOOL
BUILDING: MAIN BUILDING

M-GWT-75
M-GWT-76

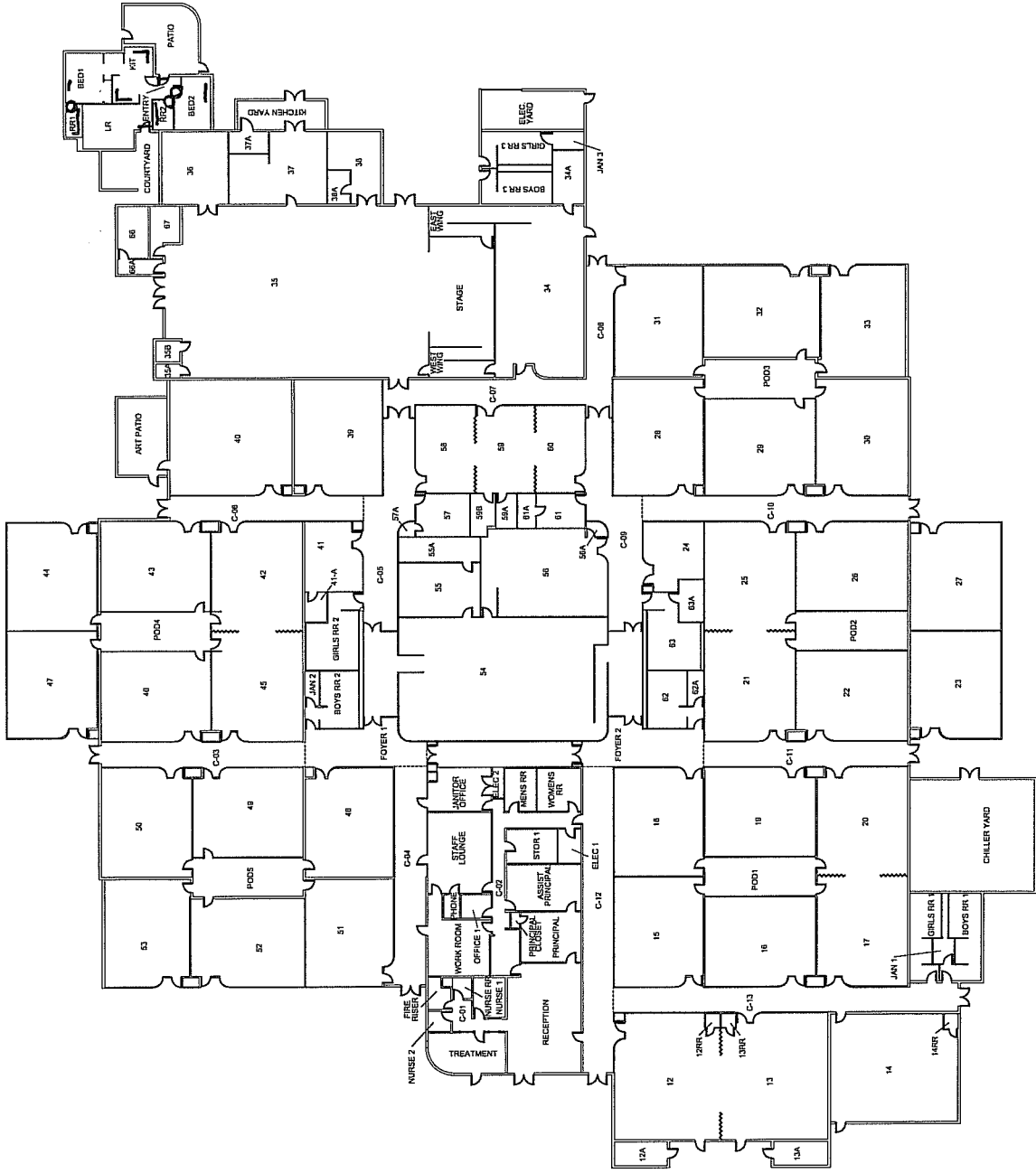

FLOOR PLAN
N.T.S.



PROJECT: AHERA ASBESTOS INSPECTION

CLIENT: KYRENE SCHOOL DISTRICT NO. 28

SITE: KYRENE DE LA ESPERANZA ELEMENTARY SCHOOL

BUILDING: MAIN BUILDING

ASST-77

PROJ. NO.: 08-085

DATE: 03.05.08

DRAWN BY: JGA

CHECKED BY: CR



FM GROUP INC
15974 N. 77TH STREET
SUITE 100
SCOTTSDALE, AZ 85260
Phone: (602) 277-7877
Fax: (602) 277-8288

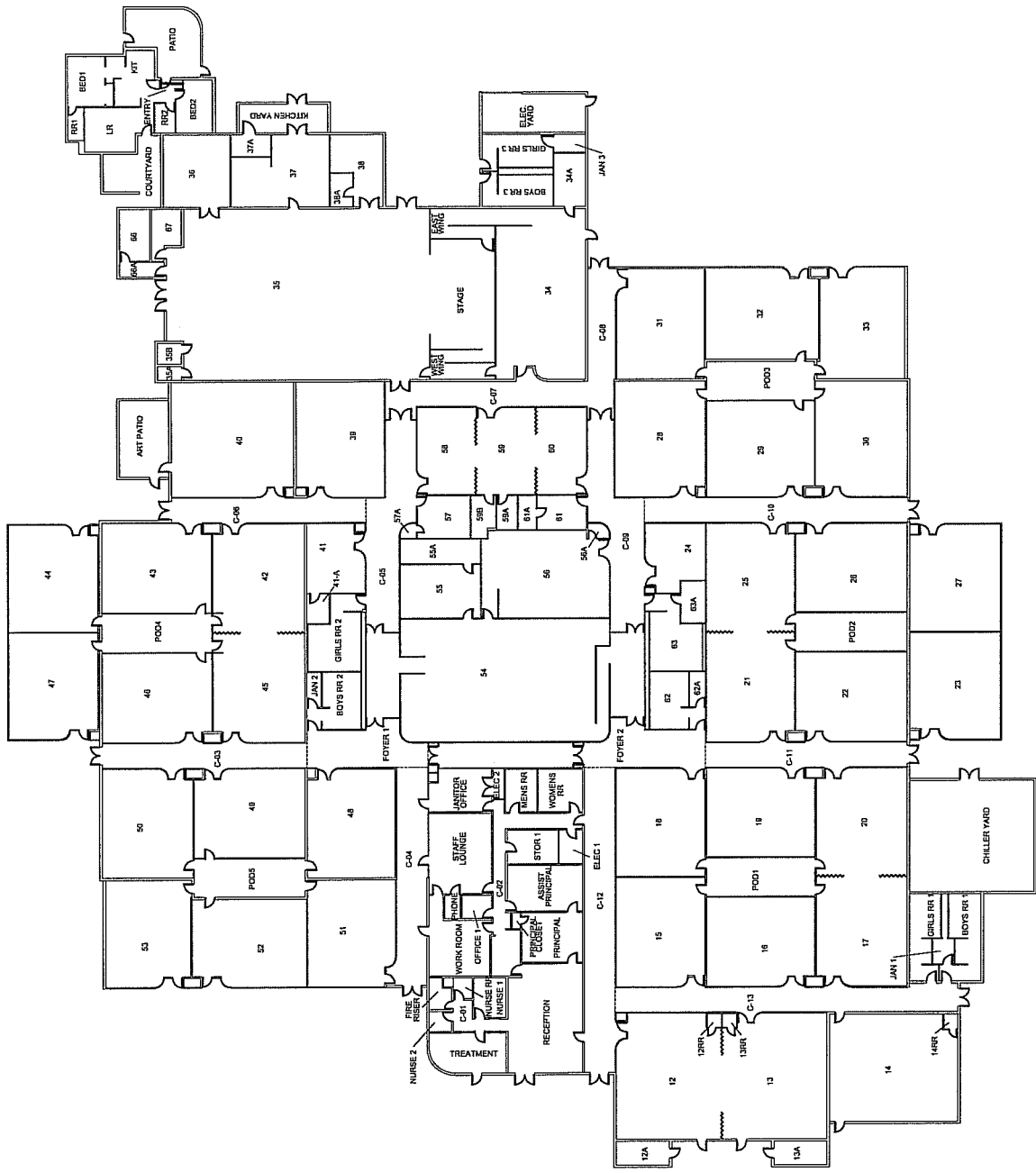

FLOOR PLAN
N.T.S.

NORTH

PROJECT: AHIERA ASBESTOS INSPECTION

CLIENT: KYRENE SCHOOL DISTRICT NO. 28

SITE: KYRENE DE LA ESPERANZA ELEMENTARY SCHOOL

BUILDING: MAIN BUILDING

M-GR-78

PROJ. NO.: 08-085

DATE: 03.05.08

DRAWN BY: JGA

CHECKED BY: CR



FM GROUP INC
15974 N. 77TH STREET
SUITE 100
SCOTTSDALE, AZ 85260
Phone: (602) 277-7877
Fax: (602) 277-8288

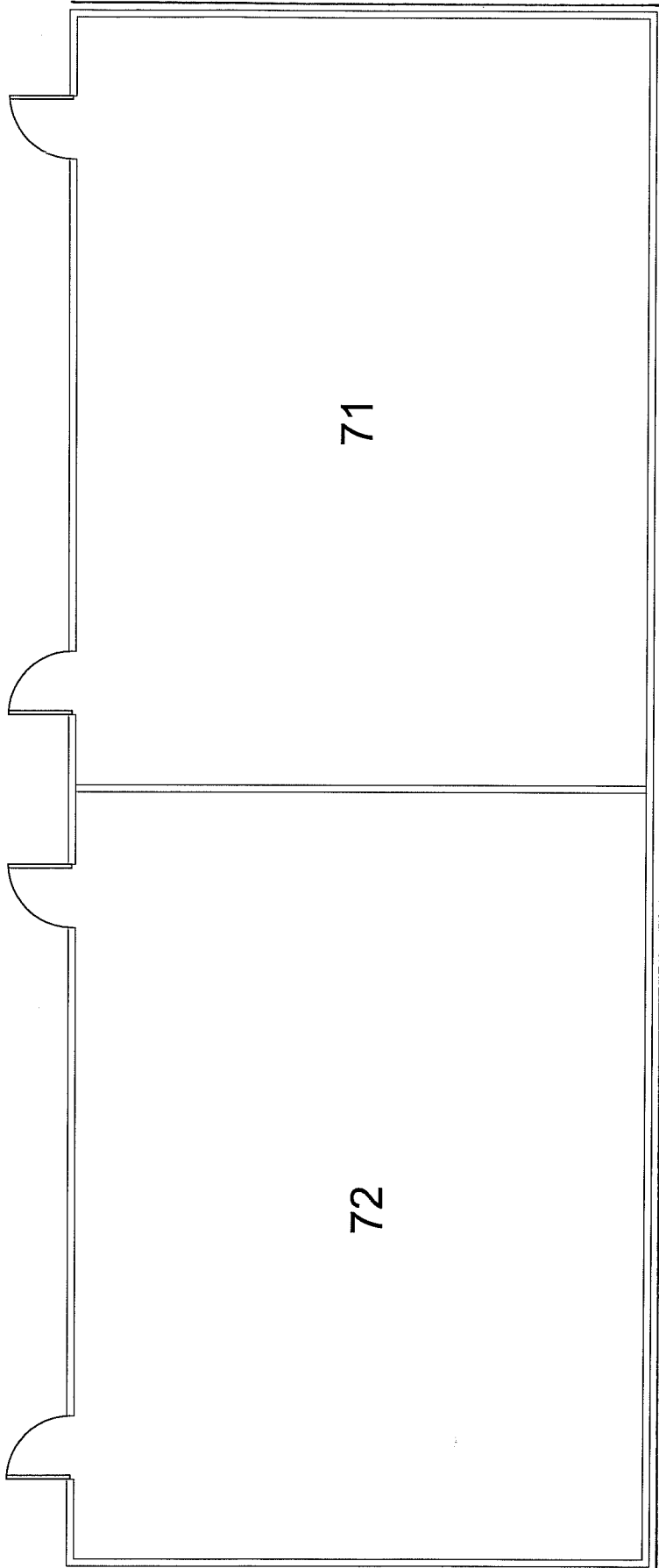

FLOOR PLAN

N.T.S.



NORTH

PROJECT: AHERA ASBESTOS INSPECTION

CLIENT: KYRENE SCHOOL DISTRICT NO. 28

SITE: KYRENE DE LA ESPERANZA ELEMENTARY SCHOOL

BUILDING: PORTABLE 71/72

M-CM-U-OI

MA-MRT. 02

PROJ. NO: 06-085

DATE: 03.05.08

DRAWN BY: JCA

CHECKED BY: CR

FM GROUP INC
15974 N. 77TH STREET
SUITE 100
SCOTTSDALE, AZ 85260

Phone: (602) 277-7877
Fax: (602) 277-8288



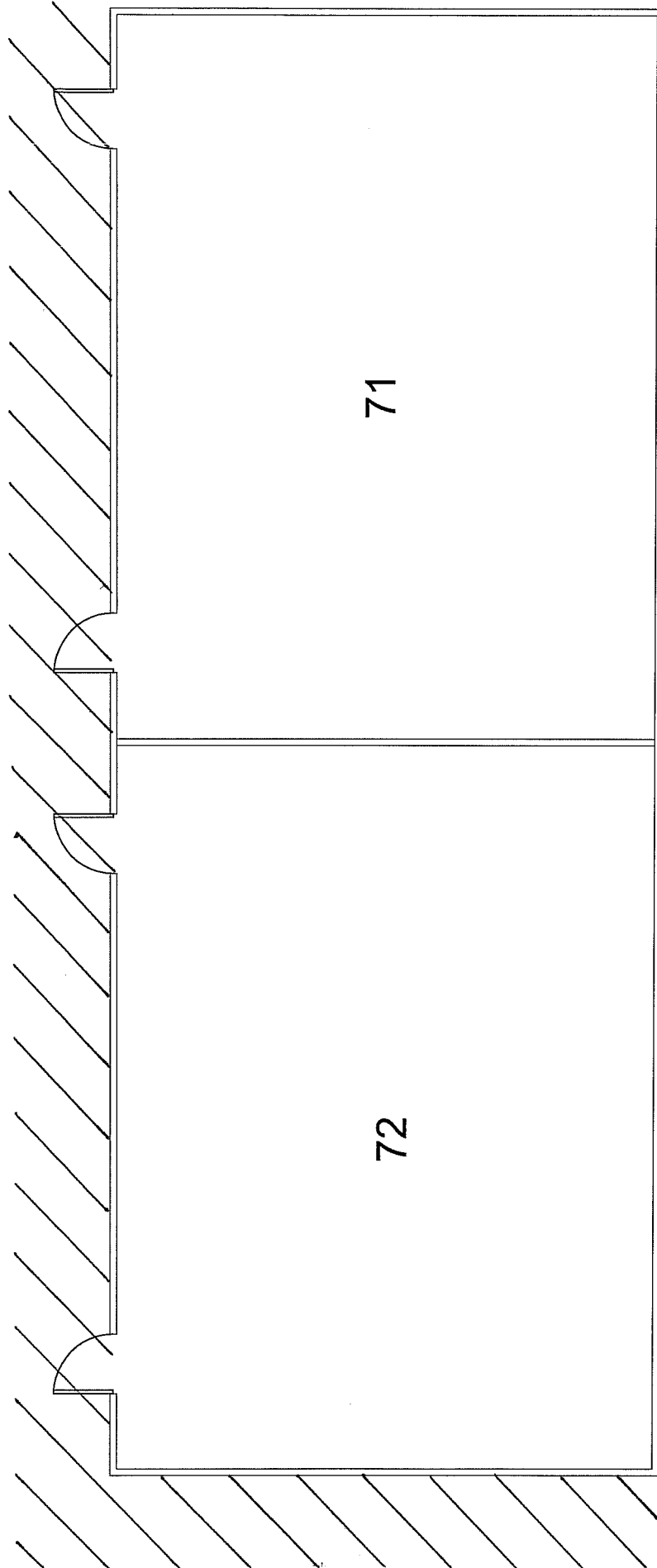

71

72

FLOOR PLAN
N.T.S.



PROJECT: AHERA ASBESTOS INSPECTION

CLIENT: KYRENE SCHOOL DISTRICT NO. 28

SITE: KYRENE DE LA ESPERANZA ELEMENTARY SCHOOL

BUILDING: PORTABLE 71/72

M-CON-03

PROJ. NO: 08-085

DATE: 03.05.08

DRAWN BY: JGA

CHECKED BY: CR



FM GROUP INC
15974 N. 77TH STREET
SUITE 100
SCOTTSDALE, AZ 85260
Phone: (602) 277-7877
Fax: (602) 277-8288

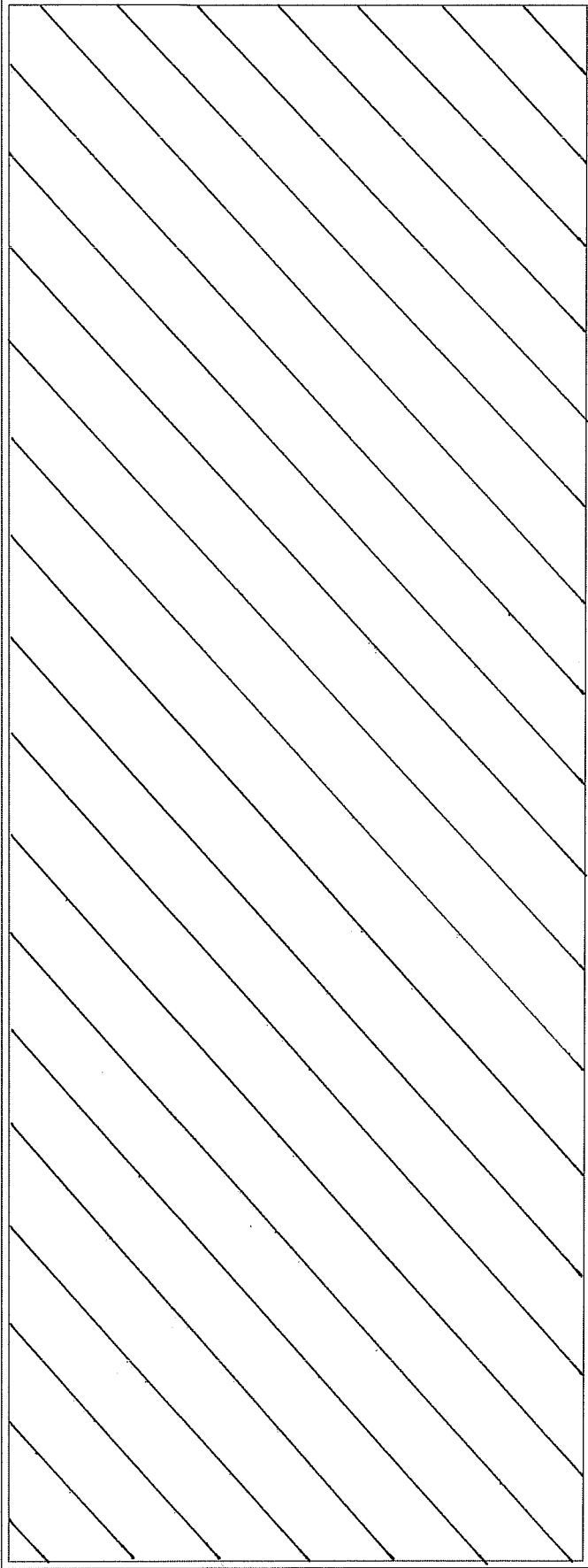

ROOF PLAN

N.T.S.



NORTH

PROJECT: AHERA ASBESTOS INSPECTION

CLIENT: KYRENE SCHOOL DISTRICT NO. 28

SITE: KYRENE DE LA ESPERANZA ELEMENTARY SCHOOL

BUILDING: PORTABLE 7172

M-008-04

M-11-15-05

PROJ. NO: 08-085

DATE: 03.05.08

DRAWN BY: JGA

CHECKED BY: CR

FM GROUP INC
15974 N. 77TH STREET
SUITE 100
SCOTTSDALE, AZ 85260
Phone: (602) 277-7877
Fax: (602) 277-8288



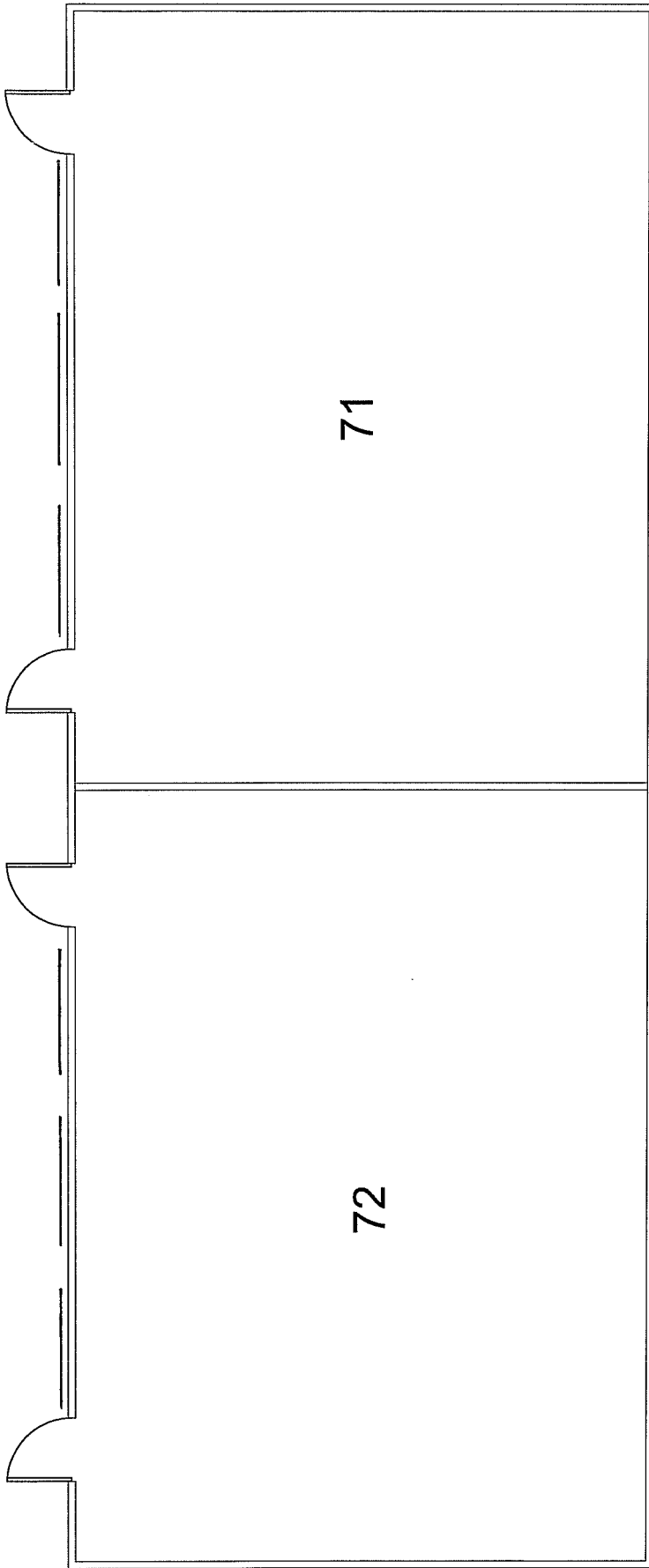

FLOOR PLAN

N.T.S.



PROJECT: AHERA ASBESTOS INSPECTION

CLIENT: KYRENE SCHOOL DISTRICT NO. 28

SITE: KYRENE DE LA ESPERANZA ELEMENTARY SCHOOL

BUILDING: PORTABLE 717Z

M-SLT-06

PROJ. NO: 08-085

DATE: 03.05.08

DRAWN BY: JGA

CHECKED BY: CR

FM GROUP INC
 15974 N. 77TH STREET
 SUITE 100
 SCOTTSDALE, AZ 85260
 Phone: (602) 277-7877
 Fax: (602) 277-8288

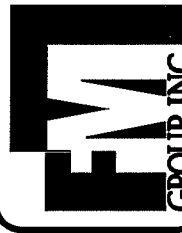

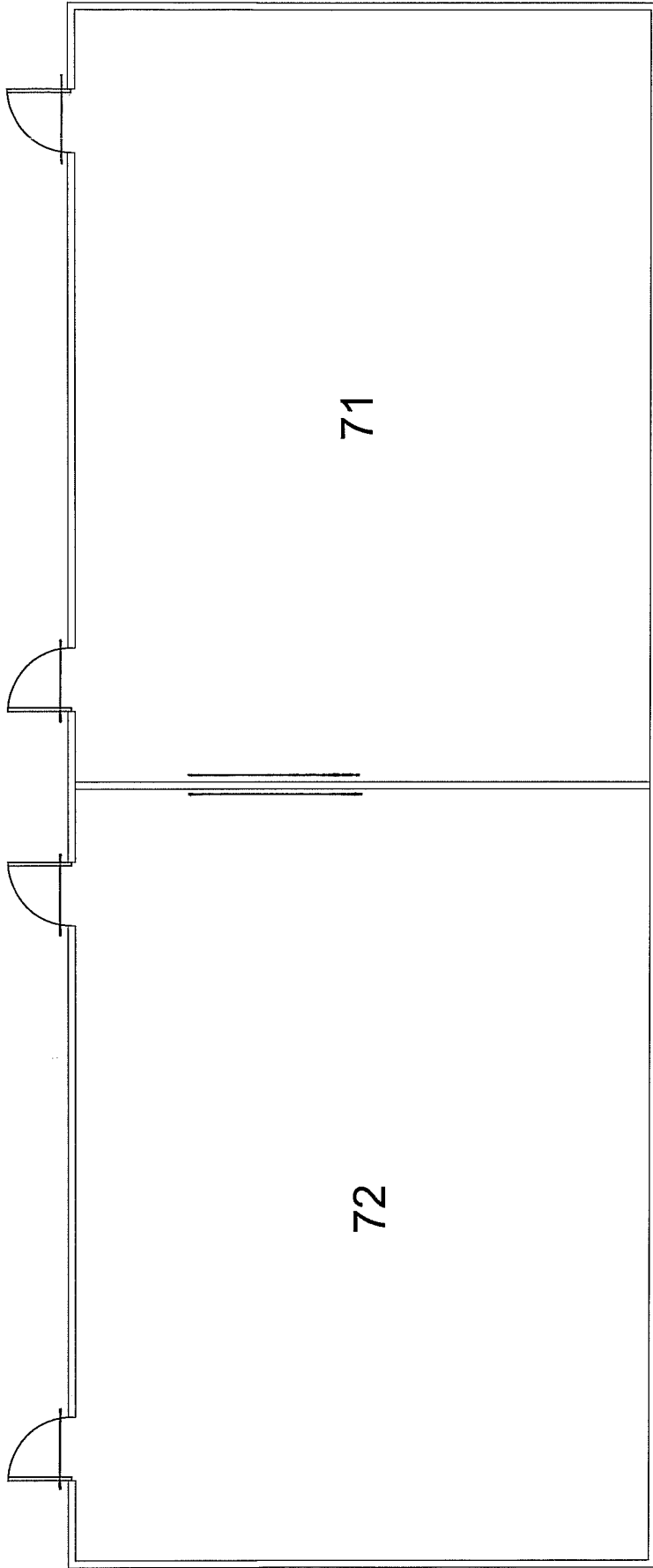

FLOOR PLAN
N.T.S.



PROJECT: AHERA ASBESTOS INSPECTION

CLIENT: KYRENE SCHOOL DISTRICT NO. 28

SITE: KYRENE DE LA ESPERANZA ELEMENTARY SCHOOL

BUILDING: PORTABLE 71172

M-SLT-07

PROJ. NO: 08-085

DATE: 03.05.08

DRAWN BY: JGA

CHECKED BY: CR



FM GROUP INC
15974 N. 77TH STREET
SUITE 100
SCOTTSDALE, AZ 85260
Phone: (602) 277-7877
Fax: (602) 277-8288



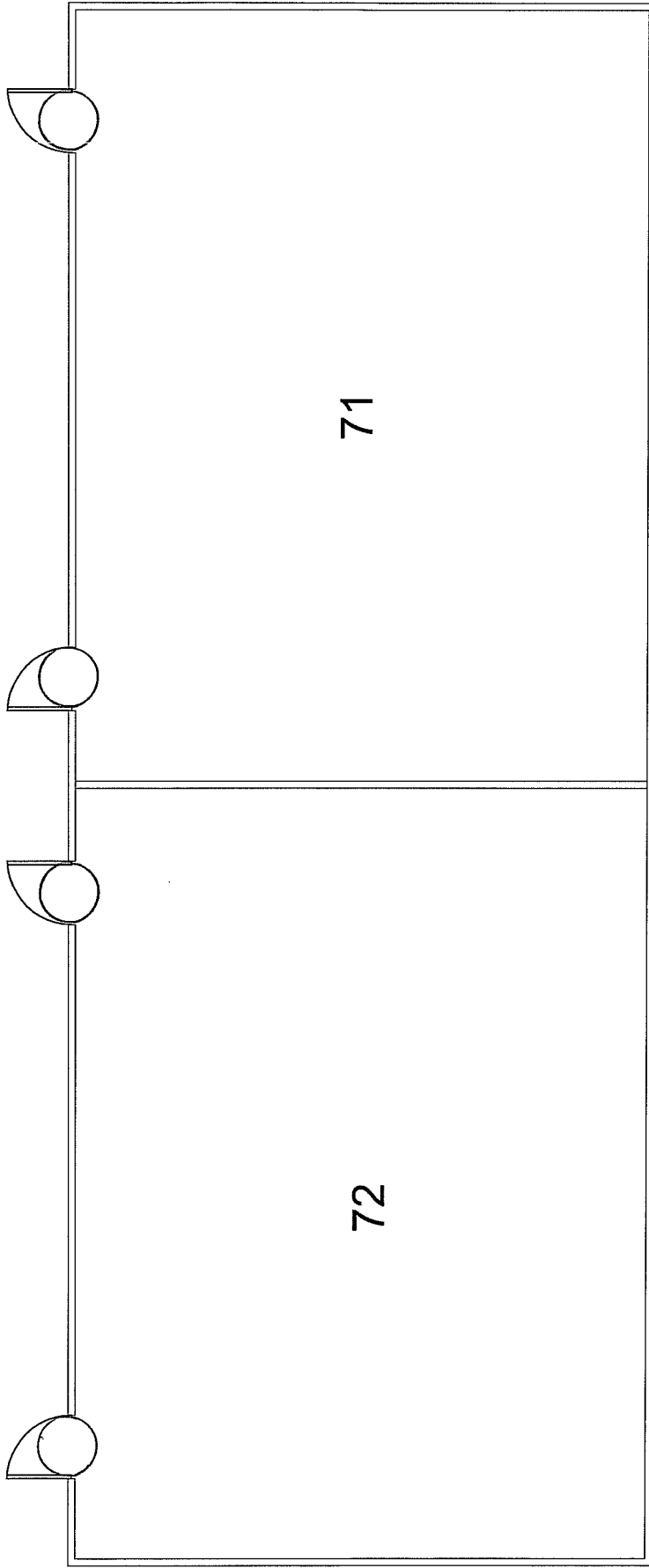

FLOOR PLAN
N.T.S.



PROJECT: AHERA ASBESTOS INSPECTION

CLIENT: KYRENE SCHOOL DISTRICT NO. 28

SITE: KYRENE DE LA ESPERANZA ELEMENTARY SCHOOL

BUILDING: PORTABLE 717Z

M-FDI-08

PROJ. NO: 08-085

DATE: 03.05.08

DRAWN BY: JGA

CHECKED BY: CR



FM GROUP INC
15974 N. 77TH STREET
SUITE 100
SCOTTSDALE, AZ 85260
Phone: (602) 277-7877
Fax: (602) 277-8288

1

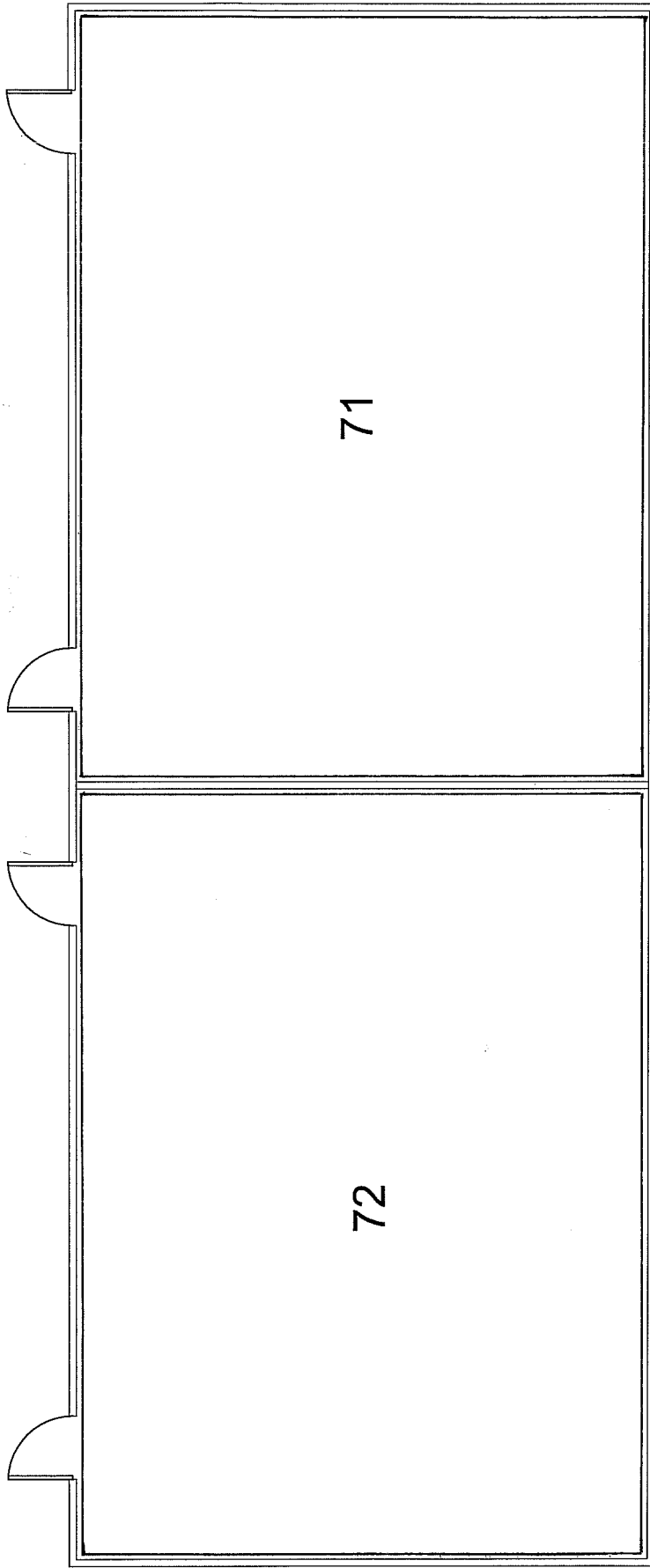

FLOOR PLAN

N.T.S.



PROJECT: AHERA ASBESTOS INSPECTION

CLIENT: KYRENE SCHOOL DISTRICT NO. 28 S-SAT-10
 SITE: KYRENE DE LA ESPERANZA ELEMENTARY SCHOOL M-6w-8-f1
 BUILDING: PORTABLE 7172 S-3TC-12

PROJ. NO: 08-085
 DATE: 03.05.08
 DRAWN BY: JCA
 CHECKED BY: CR



FM GROUP INC
 15974 N. 77TH STREET
 SUITE 100
 SCOTTSDALE, AZ 85260
 Phone: (602) 277-7877
 Fax: (602) 277-8288

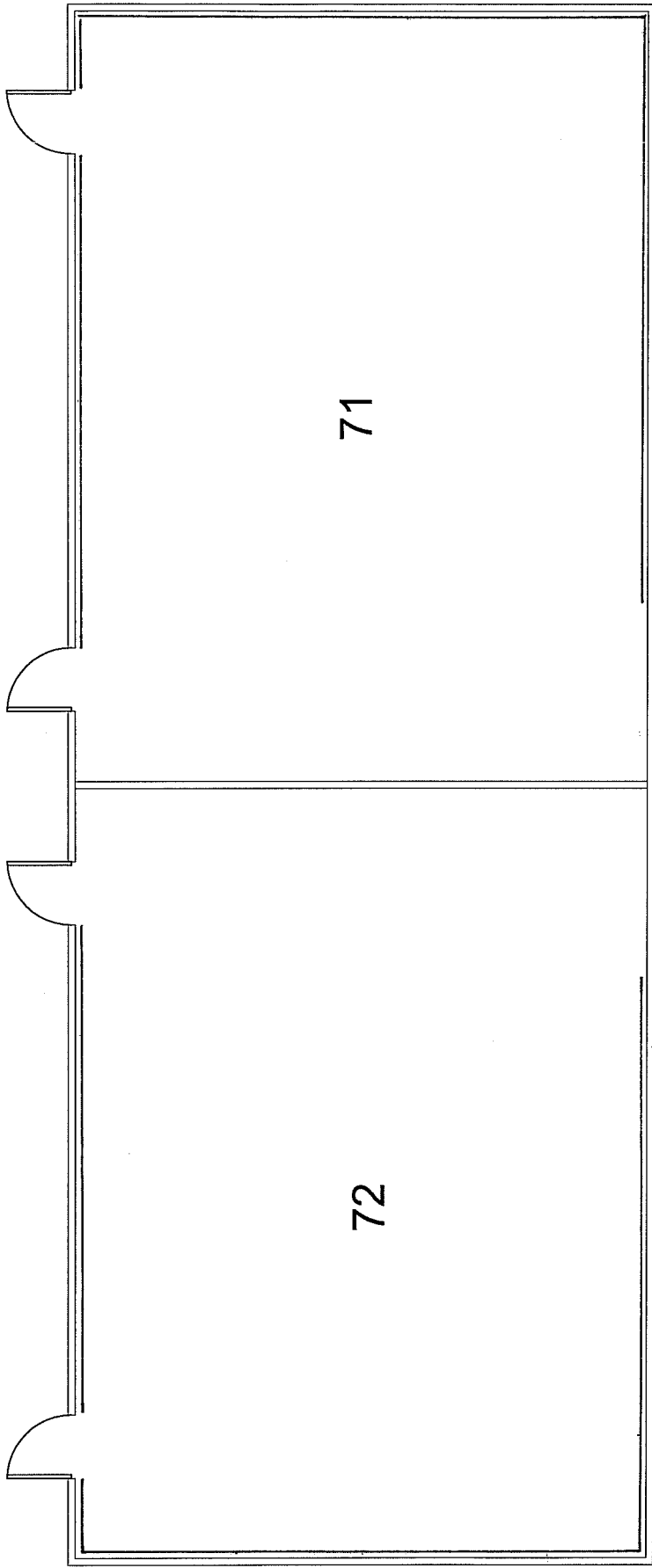

FLOOR PLAN
N.T.S.



PROJECT: AHERA ASBESTOS INSPECTION

CLIENT: KYRENE SCHOOL DISTRICT NO. 28

SITE: KYRENE DE LA ESPERANZA ELEMENTARY SCHOOL

BUILDING: PORTABLE 7172

M-TWP-13

PROJ. NO: 08-085

DATE: 03.05.08

DRAWN BY: JGA

CHECKED BY: CR



FM GROUP INC
15974 N. 77TH STREET
SUITE 100
SCOTTSDALE, AZ 85260
Phone: (602) 277-7877
Fax: (602) 277-8288

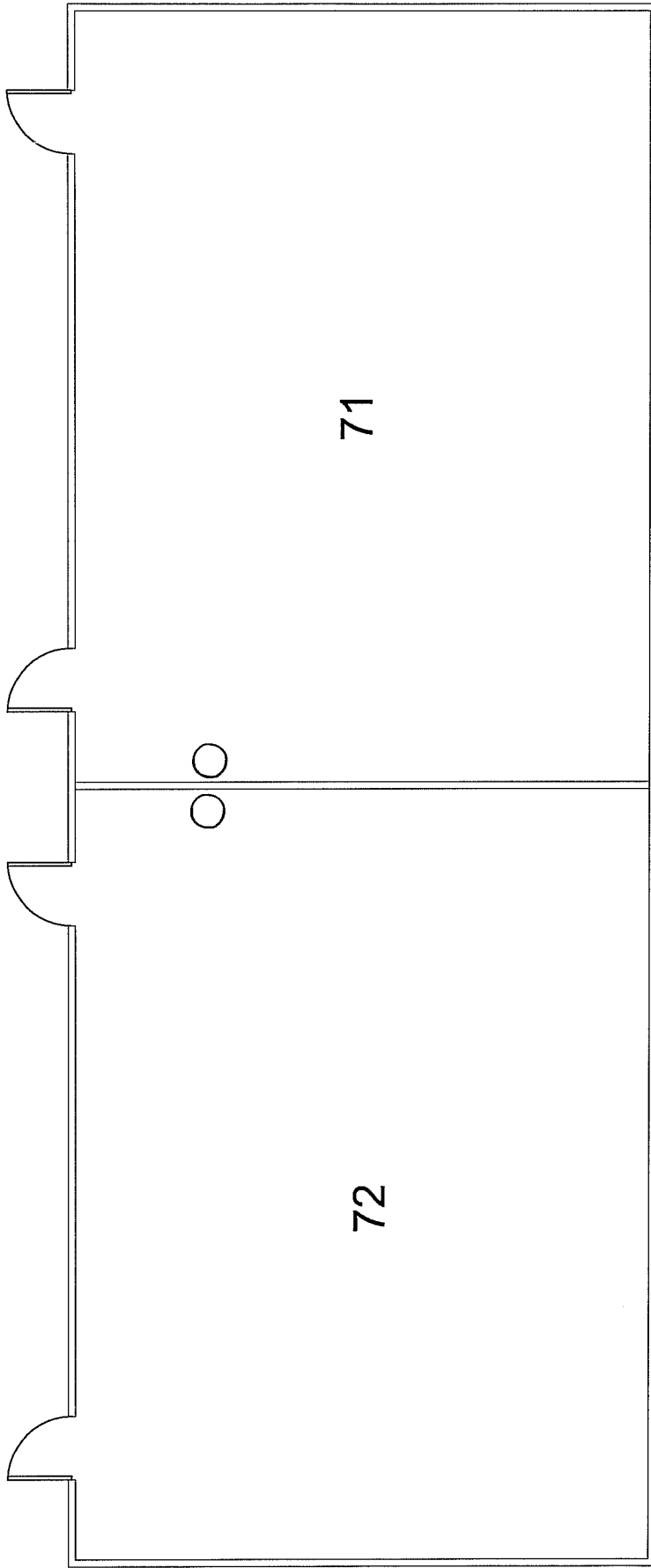

FLOOR PLAN
N.T.S.



PROJECT: AHERA ASBESTOS INSPECTION
 CLIENT: KYRENE SCHOOL DISTRICT NO. 28
 SITE: KYRENE DE LA ESPERANZA ELEMENTARY SCHOOL
 BUILDING: PORTABLE 7172 / M-SAC-14

PROJ. NO: 08-085
 DATE: 03.05.08
 DRAWN BY: JGA
 CHECKED BY: CR



FM GROUP INC
 15974 N. 77TH STREET
 SUITE 100
 SCOTTSDALE, AZ 85260
 Phone: (602) 277-7877
 Fax: (602) 277-8288

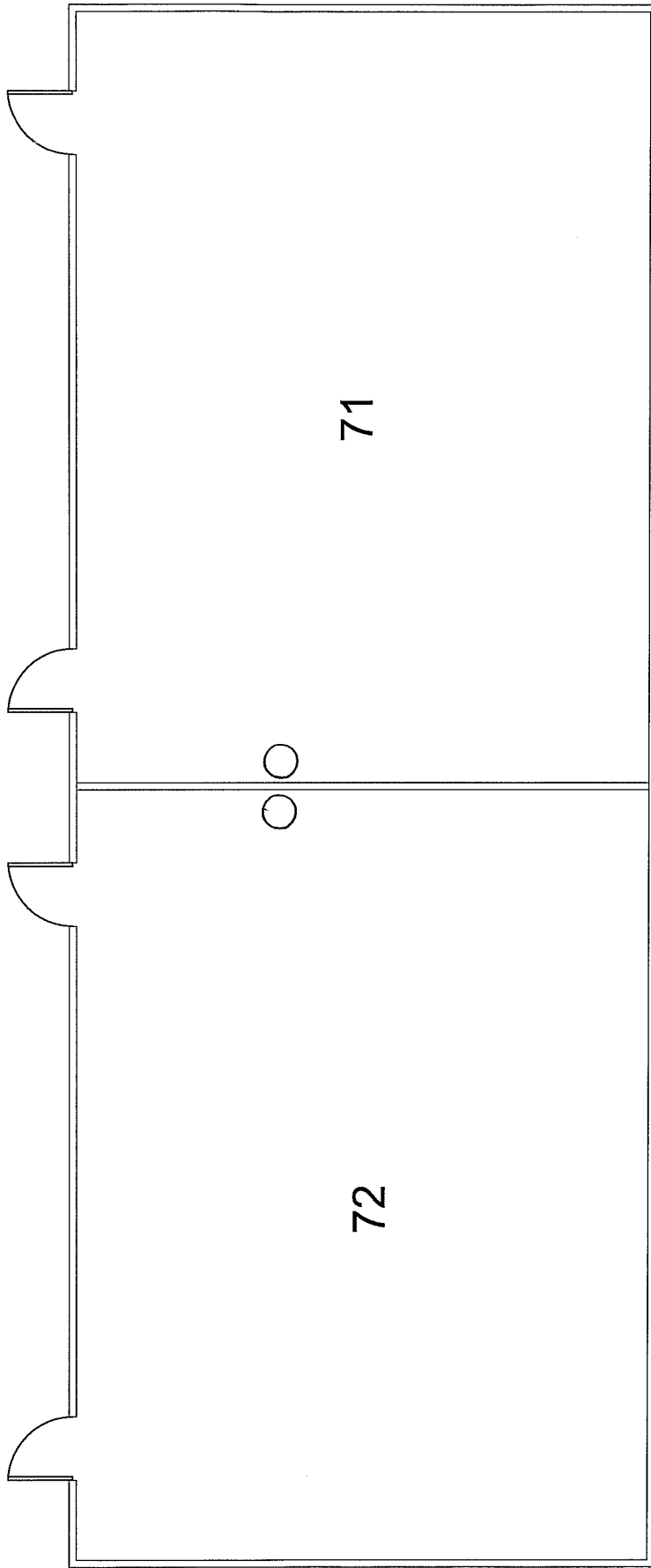

FLOOR PLAN

N.T.S.



PROJECT: AHERA ASBESTOS INSPECTION

CLIENT: KYRENE SCHOOL DISTRICT NO. 28

SITE: KYRENE DE LA ESPERANZA ELEMENTARY SCHOOL

BUILDING: PORTABLE 7172

M-SAC-15

PROJ. NO: 08-085

DATE: 03.05.08

DRAWN BY: JGA

CHECKED BY: CR

FM GROUP INC
 15974 N. 77TH STREET
 SUITE 100
 SCOTTSDALE, AZ 85260
 Phone: (602) 277-7877
 Fax: (602) 277-8288

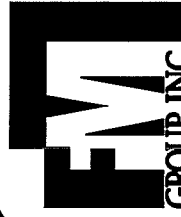

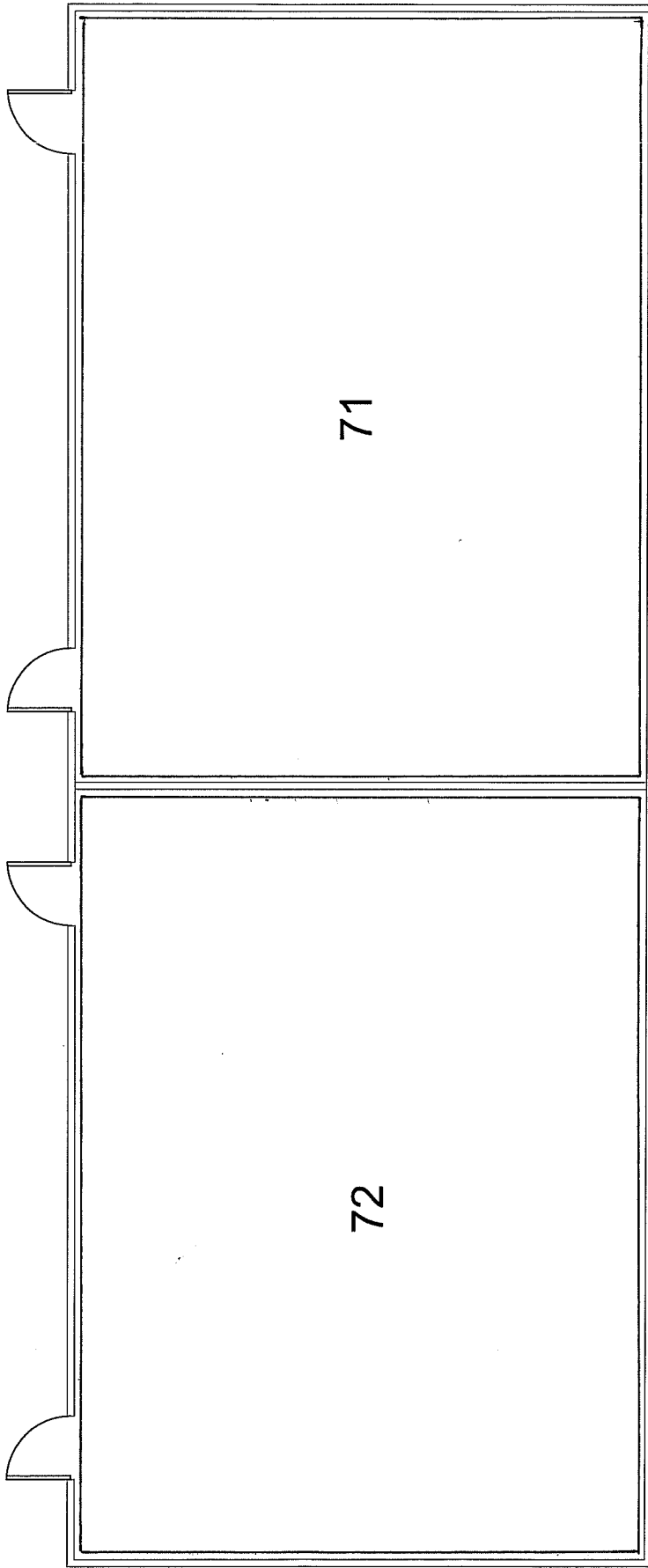

FLOOR PLAN

N.T.S.



PROJECT: AHERA ASBESTOS INSPECTION

CLIENT: KYRENE SCHOOL DISTRICT NO. 28

SITE: KYRENE DE LA ESPERANZA ELEMENTARY SCHOOL

BUILDING: PORTABLE 71/72

MWA8-16

M-ADH-17

PROJ. NO: 08-085

DATE: 03.05.08

DRAWN BY: JGA

CHECKED BY: CR

FM GROUP INC
 15974 N. 77TH STREET
 SUITE 100
 SCOTTSDALE, AZ 85260
 Phone: (602) 277-7877
 Fax: (602) 277-8288



71

72

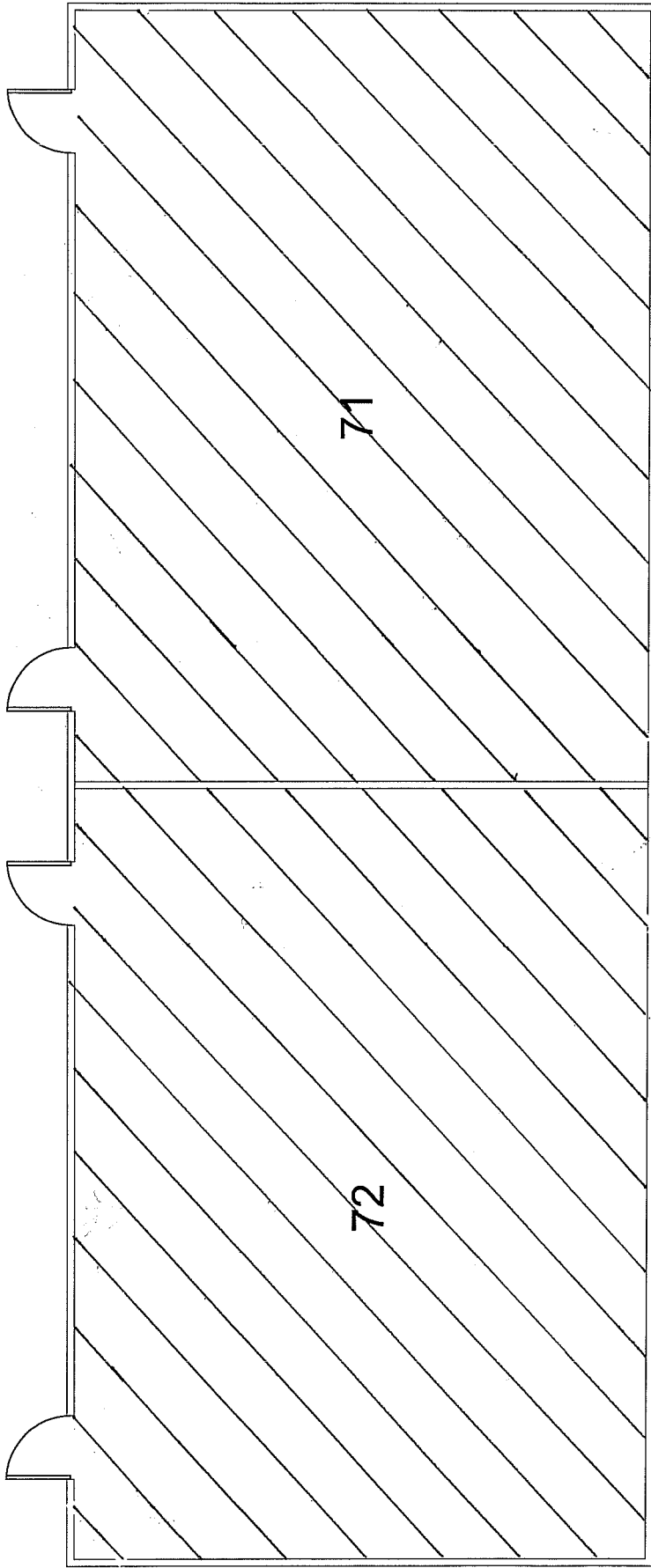

FLOOR PLAN

N.T.S.



PROJECT: AHIERA ASBESTOS INSPECTION

CLIENT: KYRENE SCHOOL DISTRICT NO. 28

SITE: KYRENE DE LA ESPERANZA ELEMENTARY SCHOOL

BUILDING: PORTABLE 717Z

M. CPT. 19

M. MAS. 19

PROJ. NO.: 08-085

DATE: 03.05.08

DRAWN BY: JGA

CHECKED BY: CR

FM GROUP INC
 15974 N. 77TH STREET
 SUITE 100
 SCOTTSDALE, AZ 85260
 Phone: (602) 277-7877
 Fax: (602) 277-8288



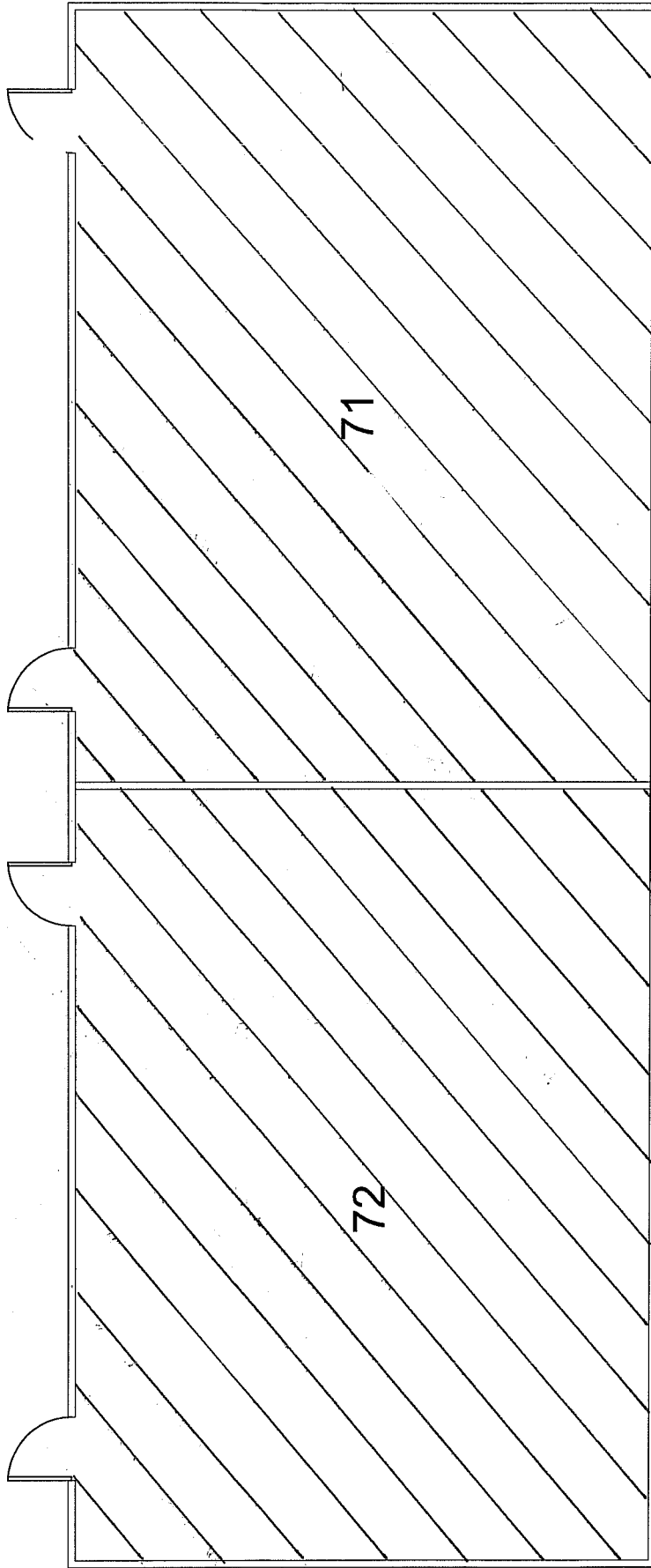

FLOOR PLAN
N.T.S.



PROJECT: AHERA ASBESTOS INSPECTION

CLIENT: KYRENE SCHOOL DISTRICT NO. 28

SITE: KYRENE DE LA ESPERANZA ELEMENTARY SCHOOL

BUILDING: PORTABLE 7172

M-D ST - 20

PROJ. NO.: 08-085

DATE: 03.05.08

DRAWN BY: JGA

CHECKED BY: CR

FM GROUP INC
15974 N. 77TH STREET
SUITE 100
SCOTTSDALE, AZ 85260
Phone: (602) 277-7877
Fax: (602) 277-8288



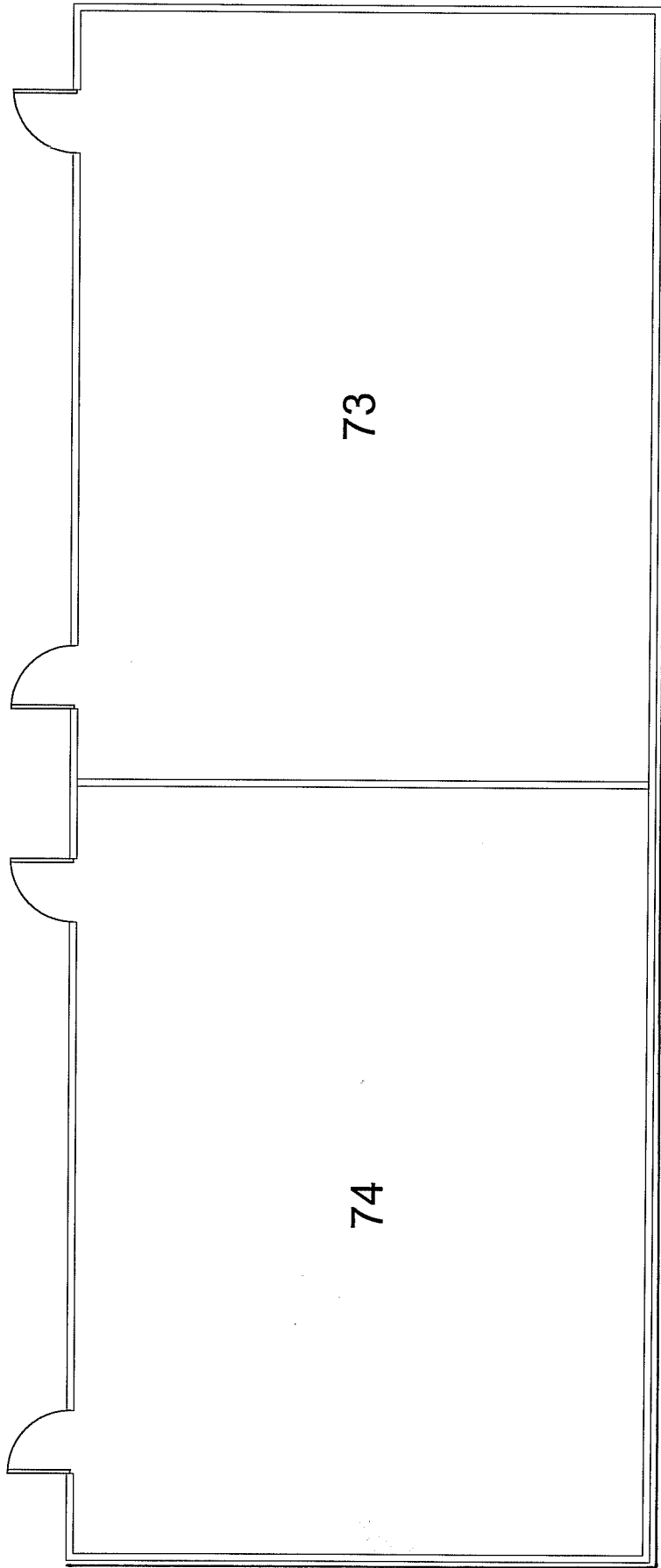

FLOOR PLAN
N.T.S.



PROJECT: AHERA ASBESTOS INSPECTION

CLIENT: KYRENE SCHOOL DISTRICT NO. 28

SITE: KYRENE DE LA ESPERANZA ELEMENTARY SCHOOL

BUILDING: PORTABLE 73/74

PROJ. NO: 08-085

DATE: 03.05.08

DRAWN BY: JGA

CHECKED BY: CR

FM GROUP INC
15974 N. 77TH STREET
SUITE 100
SCOTTSDALE, AZ 85260
Phone: (602) 277-7877
Fax: (602) 277-8288



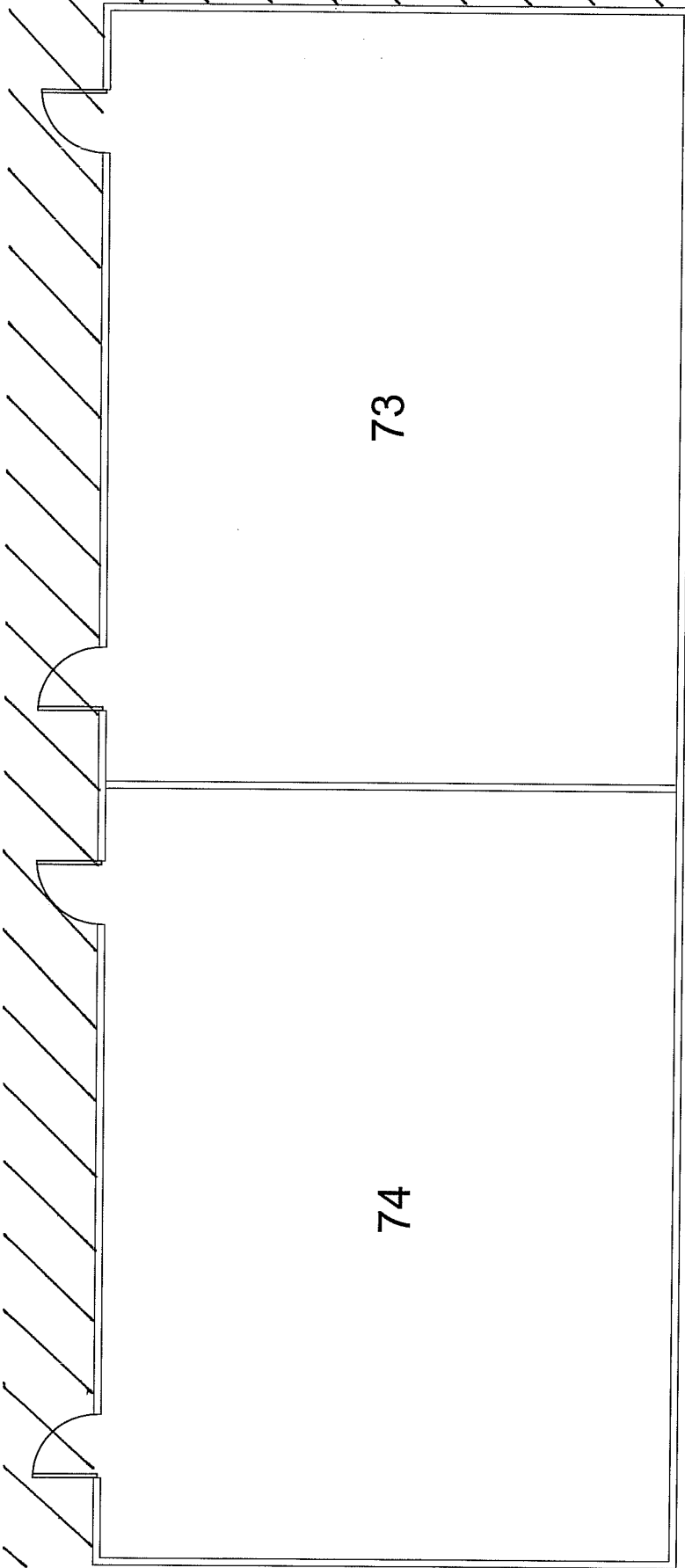

FLOOR PLAN
N.T.S.



PROJECT: AHERA ASBESTOS INSPECTION

CLIENT: KYRENE SCHOOL DISTRICT NO. 28

SITE: KYRENE DE LA ESPERANZA ELEMENTARY SCHOOL

BUILDING: PORTABLE 73/74

M-10N-05

PROJ. NO: 08-085

DATE: 03.05.08

DRAWN BY: JGA

CHECKED BY: CR

FM GROUP INC
15974 N. 77TH STREET
SUITE 100
SCOTTSDALE, AZ 85260
Phone: (602) 277-7877
Fax: (602) 277-8288



73

74

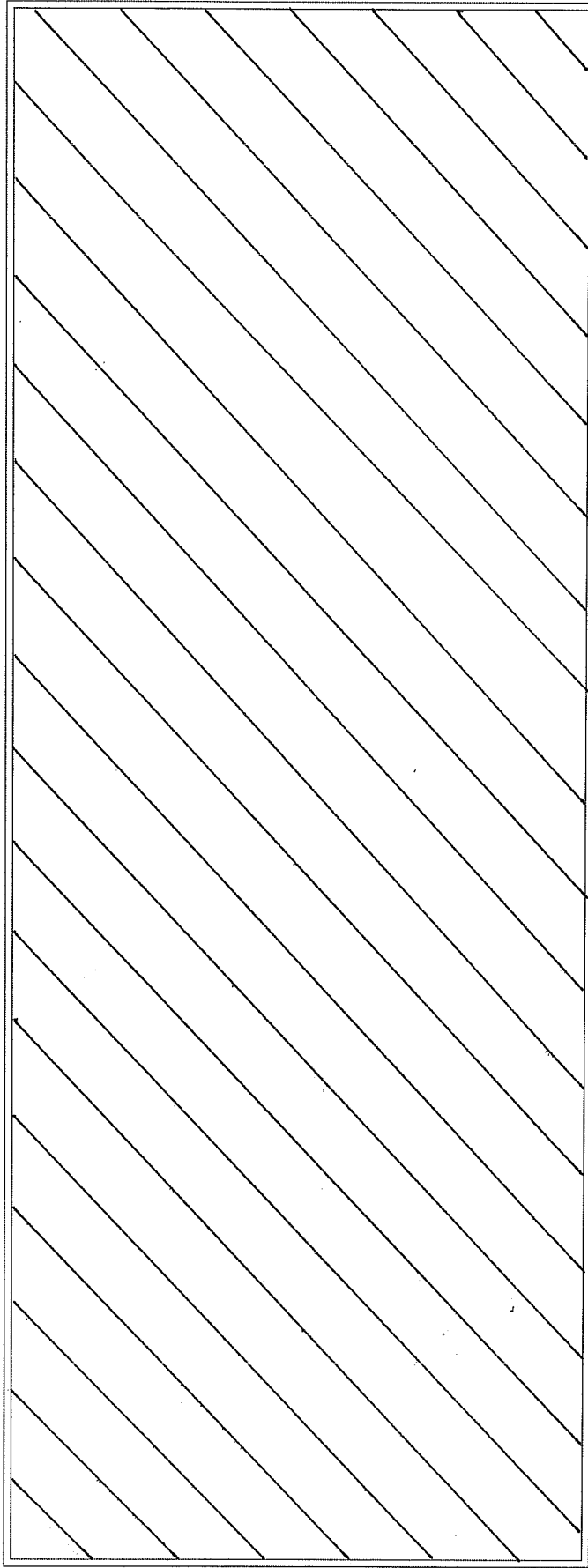

ROOF PLAN
N.T.S.



PROJECT: AHERA ASBESTOS INSPECTION

CLIENT: KYRENE SCHOOL DISTRICT NO. 28

SITE: KYRENE DE LA ESPERANZA ELEMENTARY SCHOOL

BUILDING: PORTABLE 7374

PROJ. NO.: 08-085

DATE: 03.05.08

DRAWN BY: JGA

CHECKED BY: CR



FM GROUP INC
15974 N. 77TH STREET
SUITE 100
SCOTTSDALE, AZ 85260
Phone: (602) 277-7877
Fax: (602) 277-8288

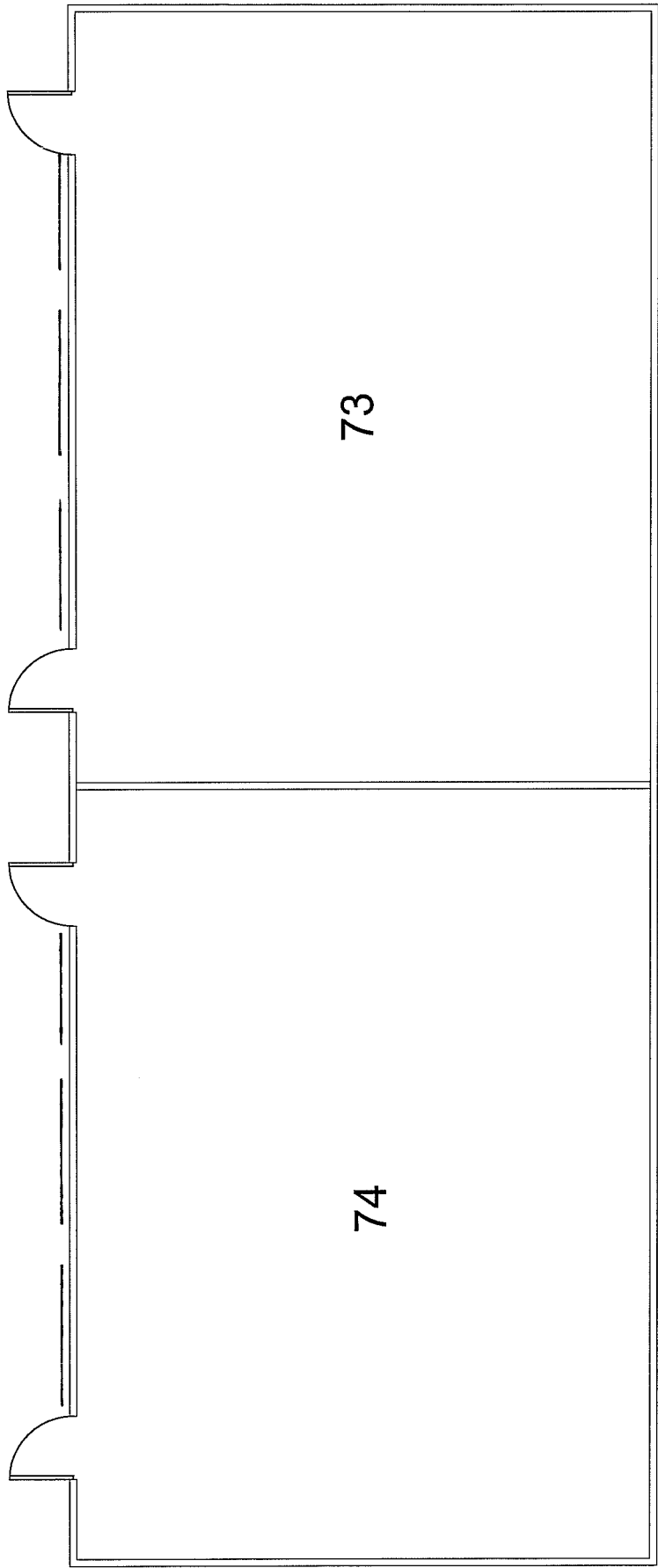

FLOOR PLAN
N.T.S.



PROJECT: AHERA ASBESTOS INSPECTION

CLIENT: KYRENE SCHOOL DISTRICT NO. 28

SITE: KYRENE DE LA ESPERANZA ELEMENTARY SCHOOL

BUILDING: PORTABLE 73/74 *M. S. L. - 06*

PROJ. NO.: 08-085

DATE: 03.05.08

DRAWN BY: JGA

CHECKED BY: CR



FM GROUP INC
15974 N. 77TH STREET
SUITE 100
SCOTTSDALE, AZ 85260
Phone: (602) 277-7877
Fax: (602) 277-8288

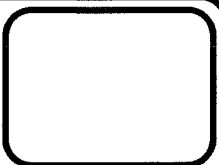

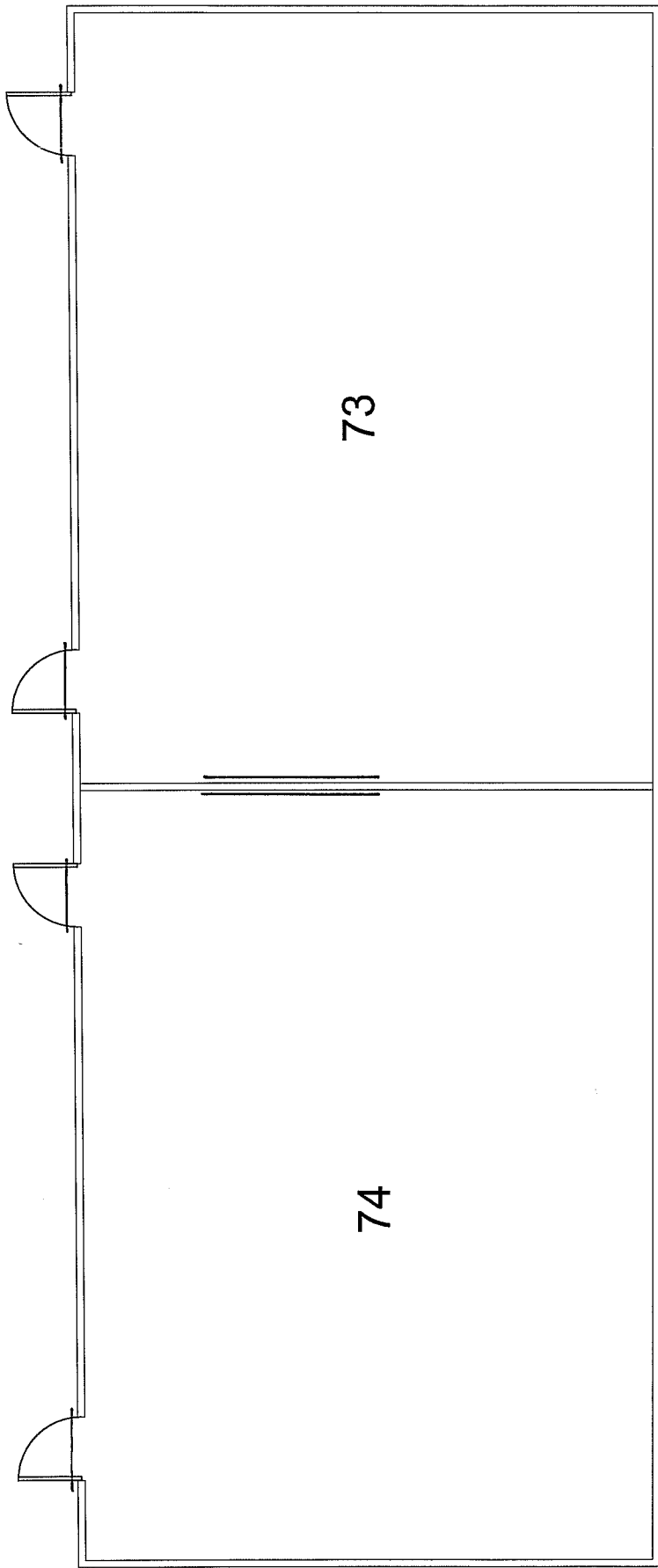

73

74

FLOOR PLAN



N.T.S.

PROJECT: AHERA ASBESTOS INSPECTION

CLIENT: KYRENE SCHOOL DISTRICT NO. 28

SITE: KYRENE DE LA ESPERANZA ELEMENTARY SCHOOL

BUILDING: PORTABLE 73/74

M-SLT-07

PROJ. NO: 08-085

DATE: 03.05.08

DRAWN BY: JGA

CHECKED BY: CR

FM GROUP INC
 15974 N. 77TH STREET
 SUITE 100
 SCOTTSDALE, AZ 85260
 Phone: (602) 277-7877
 Fax: (602) 277-8288

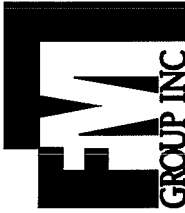

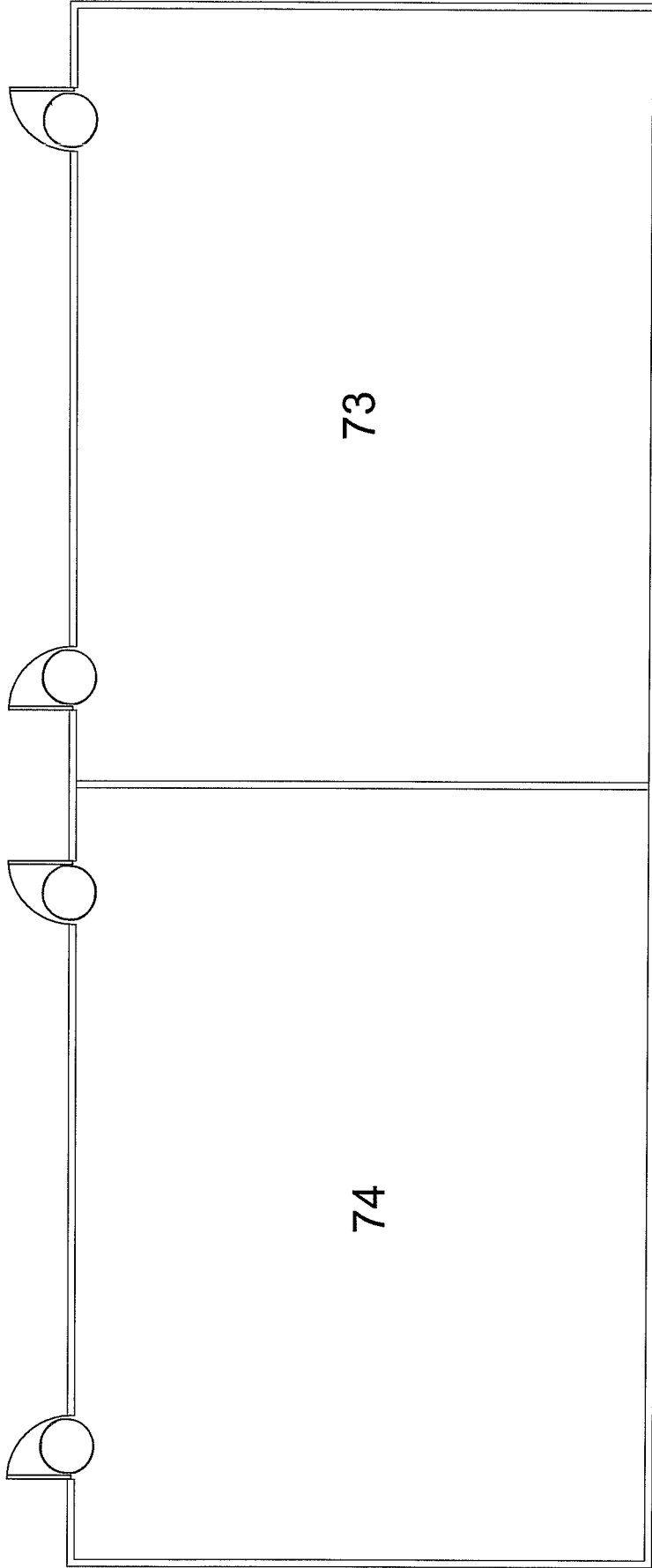

FLOOR PLAN

N.T.S.



PROJECT: AHERA ASBESTOS INSPECTION

CLIENT: KYRENE SCHOOL DISTRICT NO. 28

SITE: KYRENE DE LA ESPERANZA ELEMENTARY SCHOOL

BUILDING: PORTABLE 7374

PROJ. NO: 08-085

DATE: 03.05.08

DRAWN BY: JGA

CHECKED BY: CR

FM GROUP INC
15974 N. 77TH STREET
SUITE 100
SCOTTSDALE, AZ 85260

Phone: (602) 277-7877
Fax: (602) 277-8288



73

74

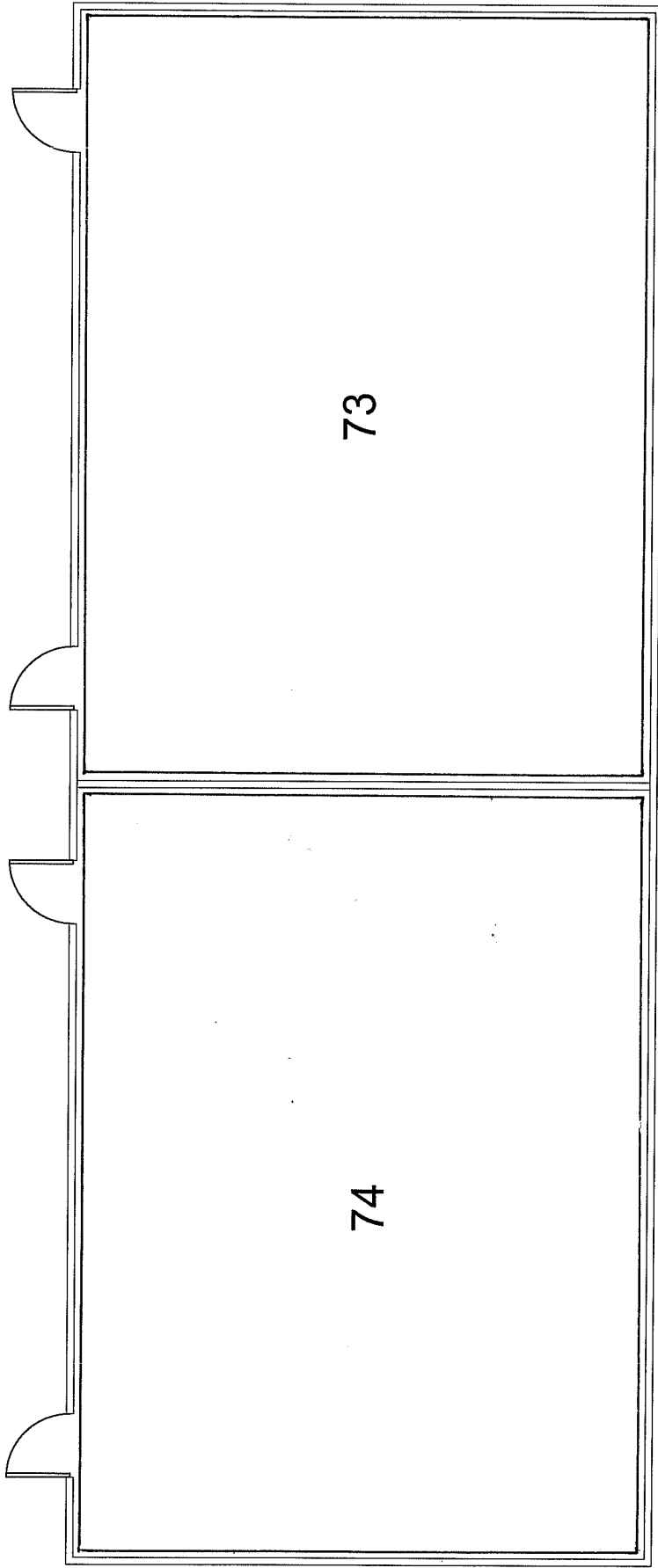

FLOOR PLAN
N.T.S.



PROJECT: AHERA ASBESTOS INSPECTION

CLIENT: KYRENE SCHOOL DISTRICT NO. 28 5-5AT-10
 SITE: KYRENE DE LA ESPERANZA ELEMENTARY SCHOOL M-GWB-11
 BUILDING: PORTABLE 73/74 5-JTC-12

PROJ. NO: 08-085
 DATE: 03.05.08
 DRAWN BY: JGA
 CHECKED BY: CR



FM GROUP INC
 15974 N. 77TH STREET
 SUITE 100
 SCOTTSDALE, AZ 85260
 Phone: (602) 277-7877
 Fax: (602) 277-8288

73

74

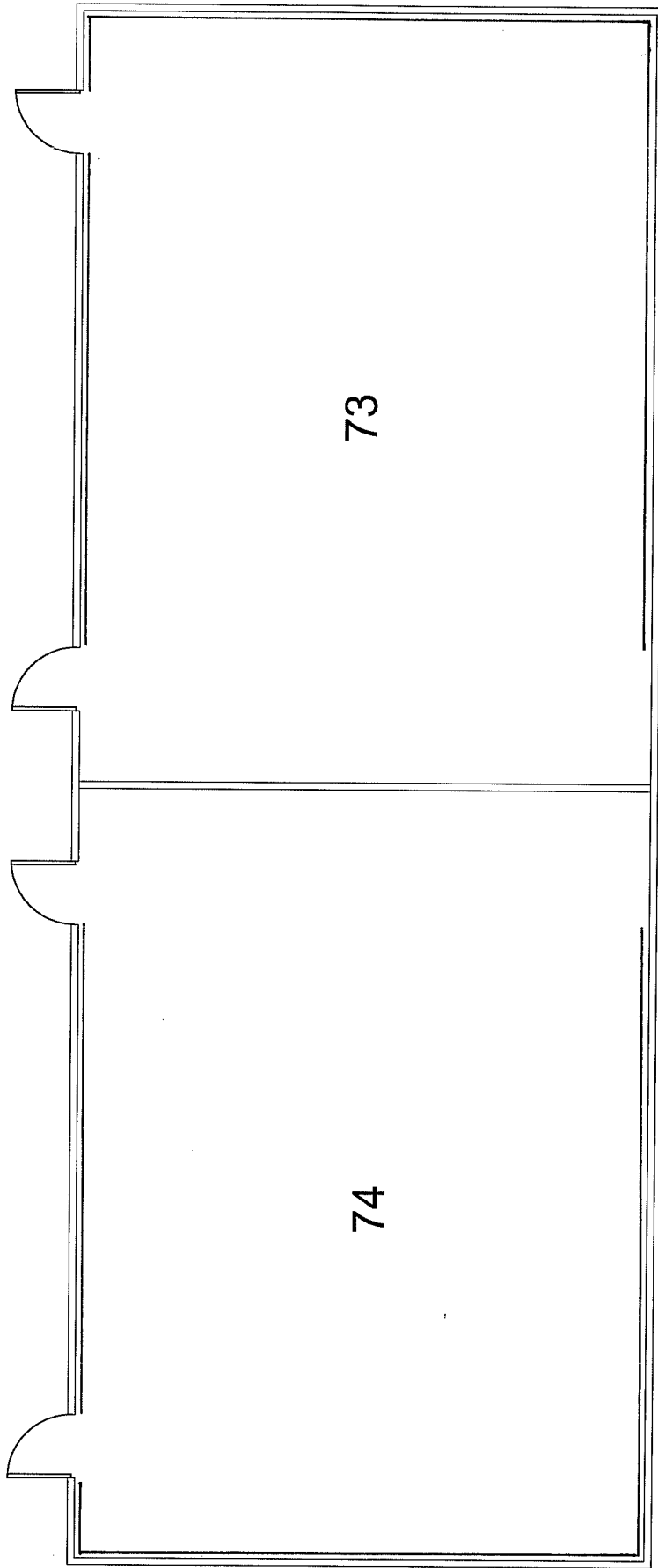

FLOOR PLAN
N.T.S.



PROJECT: AMERA ASBESTOS INSPECTION

CLIENT: KYRENE SCHOOL DISTRICT NO. 28

SITE: KYRENE DE LA ESPERANZA ELEMENTARY SCHOOL

BUILDING: PORTABLE 73/74

M-TWP-13

PROJ. NO: 08-085

DATE: 03-05-08

DRAWN BY: JGA

CHECKED BY: CR

FM GROUP INC
15974 N. 77TH STREET
SUITE 100
SCOTTSDALE, AZ 85260
Phone: (602) 277-7877
Fax: (602) 277-8288



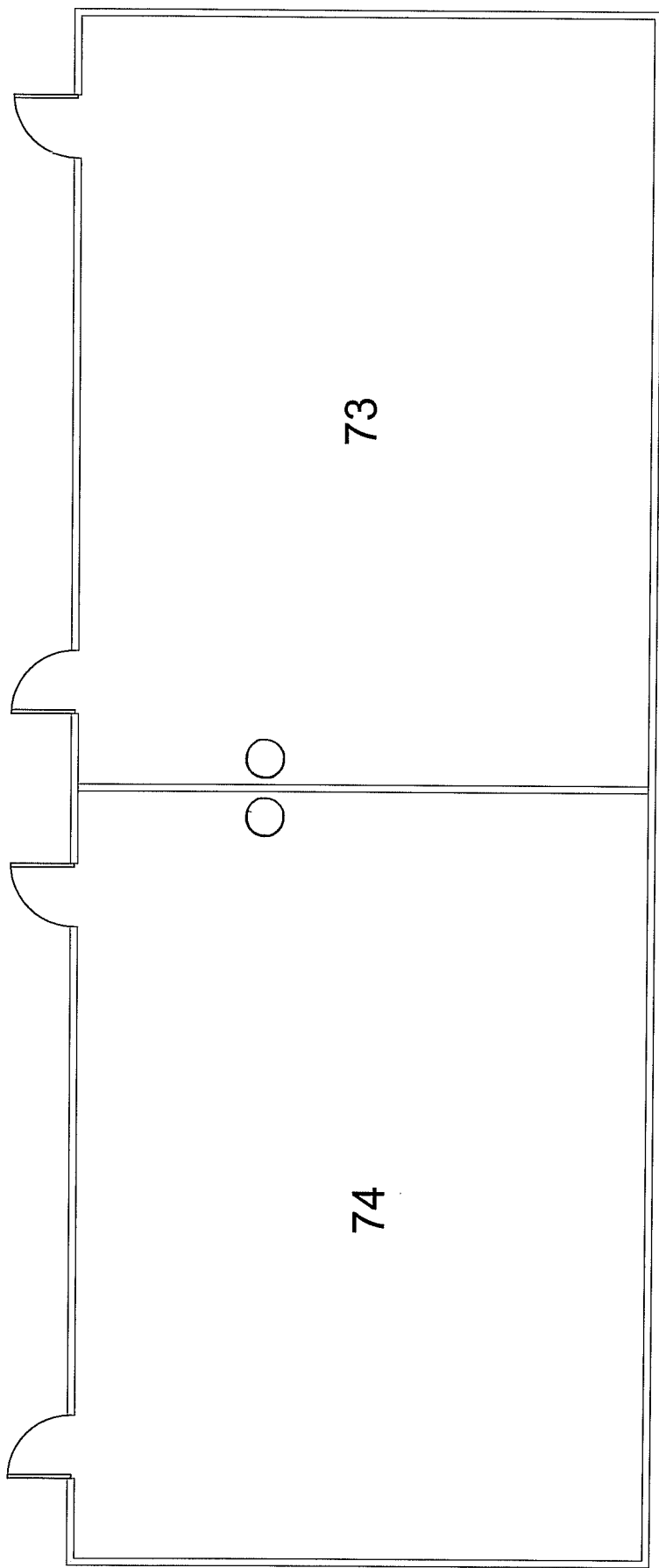

FLOOR PLAN

N.T.S.



PROJECT: AHERA ASBESTOS INSPECTION

CLIENT: KYRENE SCHOOL DISTRICT NO. 28

SITE: KYRENE DE LA ESPERANZA ELEMENTARY SCHOOL

BUILDING: PORTABLE 73/74

M. SAC - 14

PROJ. NO.: 08-085

DATE: 03.05.08

DRAWN BY: JGA

CHECKED BY: CR



FM GROUP INC
 15974 N. 77TH STREET
 SUITE 100
 SCOTTSDALE, AZ 85260
 Phone: (602) 277-7877
 Fax: (602) 277-8288

73

74

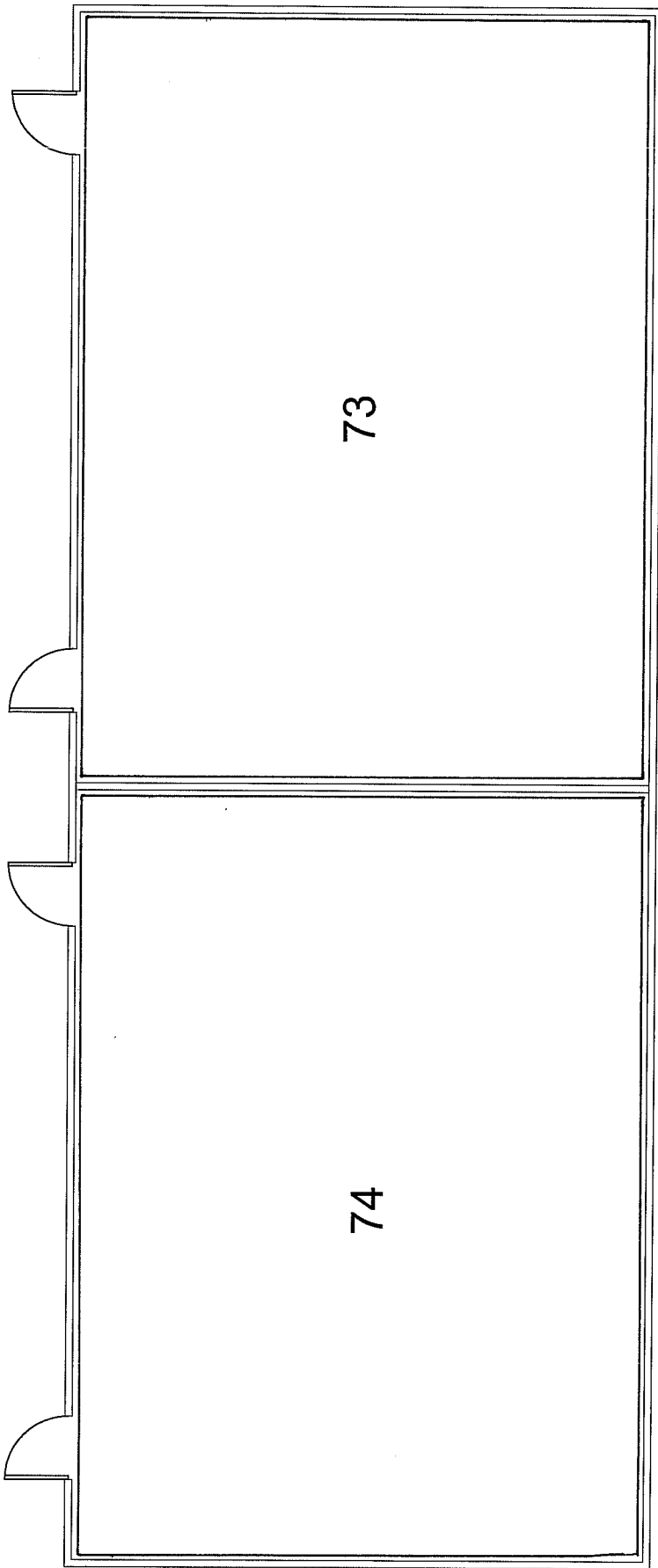

FLOOR PLAN

N.T.S.



NORTH

PROJECT: AHERA ASBESTOS INSPECTION

CLIENT: KYRENE SCHOOL DISTRICT NO. 28

SITE: KYRENE DE LA ESPERANZA ELEMENTARY SCHOOL

BUILDING: PORTABLE 73/74

M-WAB-16

M-ADH-17

PROJ. NO: 08-085

DATE: 03.05.08

DRAWN BY: JGA

CHECKED BY: CR

FM GROUP INC
 15974 N. 77TH STREET
 SUITE 100
 SCOTTSDALE, AZ 85260
 Phone: (602) 277-7877
 Fax: (602) 277-8288



73

74

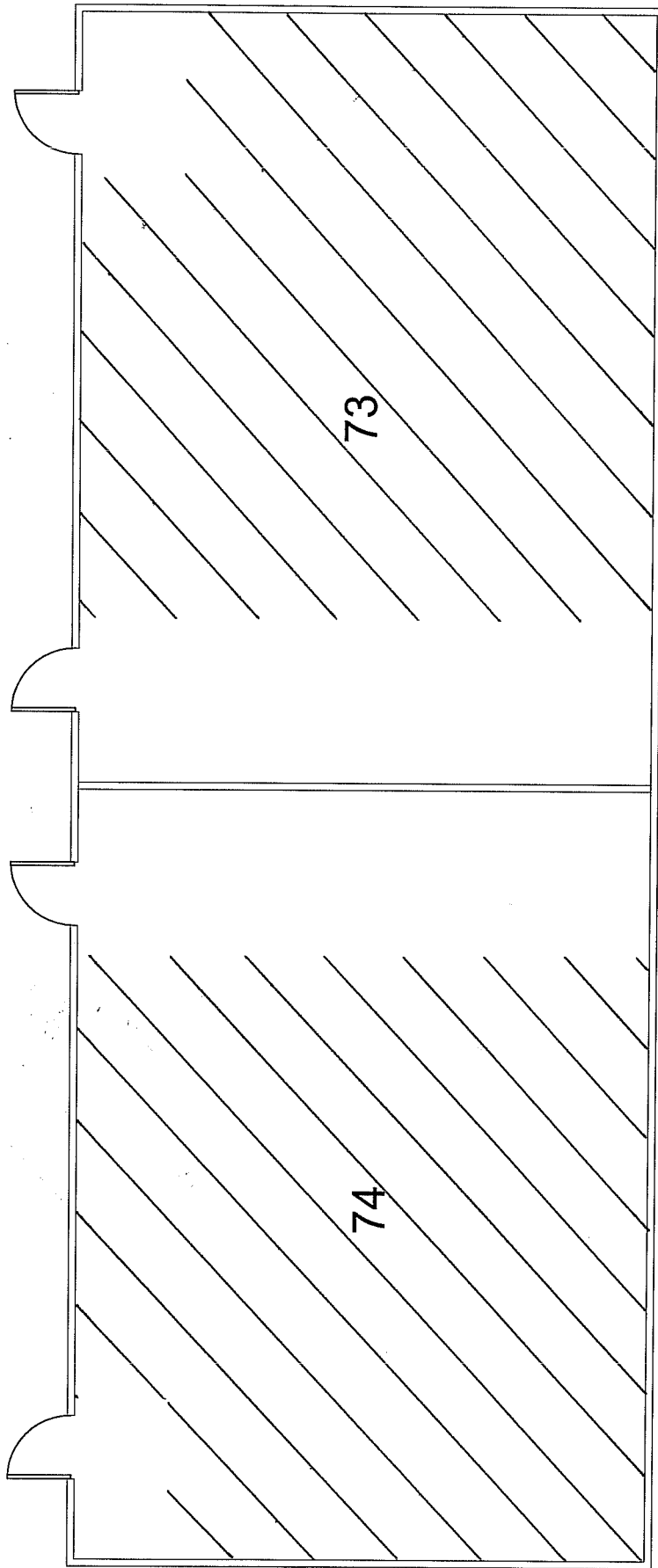

FLOOR PLAN
N.T.S.



PROJECT: AHERA ASBESTOS INSPECTION

CLIENT: KYRENE SCHOOL DISTRICT NO. 28

SITE: KYRENE DE LA ESPERANZA ELEMENTARY SCHOOL

BUILDING: PORTABLE 7374

M-CPT-18

M-14S-19

PROJ. NO: 08-085

DATE: 03.05.08

DRAWN BY: JGA

CHECKED BY: CR

FM GROUP INC
15974 N. 77TH STREET
SUITE 100
SCOTTSDALE, AZ 85260
Phone: (602) 277-7877
Fax: (602) 277-8288



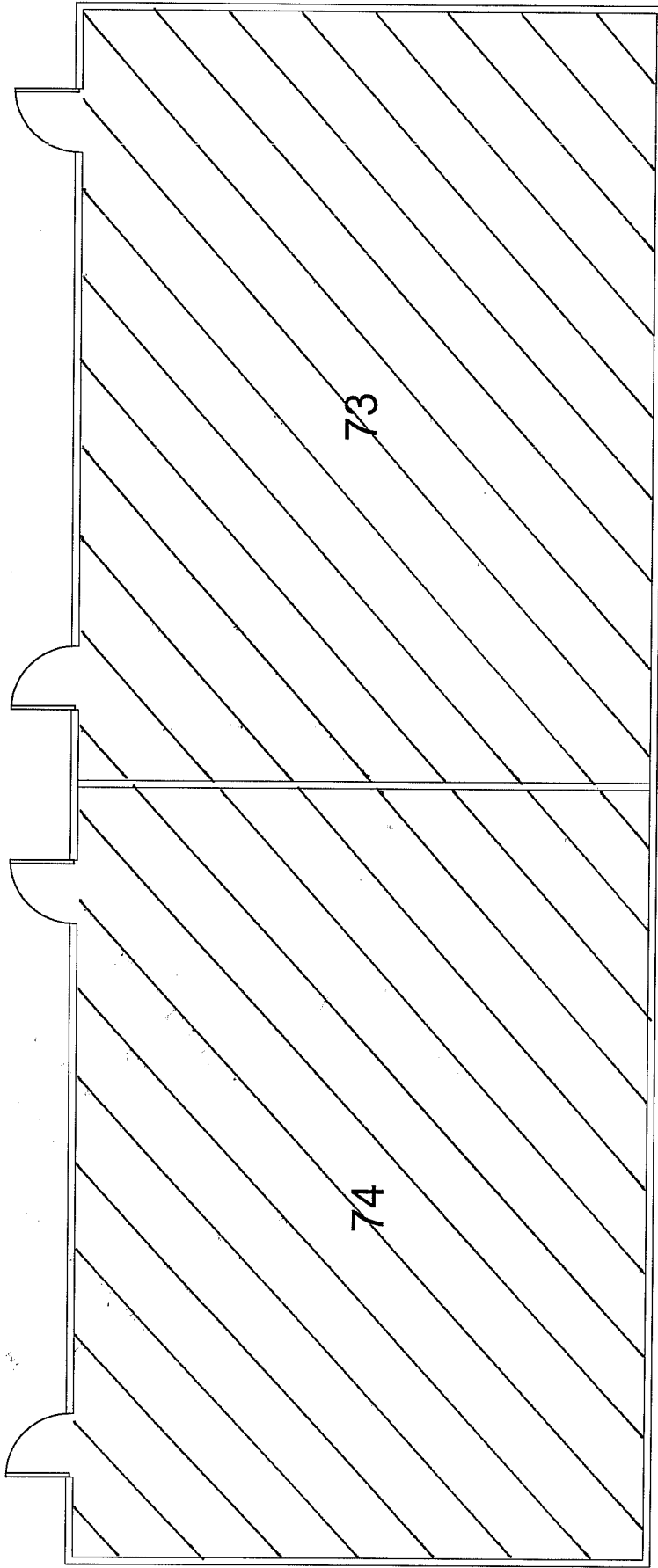

FLOOR PLAN
N.T.S.

 NORTH

PROJECT: AHERA ASBESTOS INSPECTION

CLIENT: KYRENE SCHOOL DISTRICT NO. 28

SITE: KYRENE DE LA ESPERANZA ELEMENTARY SCHOOL

BUILDING: PORTABLE 73/74

/M-DST-2.0

PROJ. NO: 08-085

DATE: 03.05.08

DRAWN BY: JGA

CHECKED BY: CR

FM GROUP INC
15974 N. 77TH STREET
SUITE 100
SCOTTSDALE, AZ 85260
Phone: (602) 277-7877
Fax: (602) 277-8288



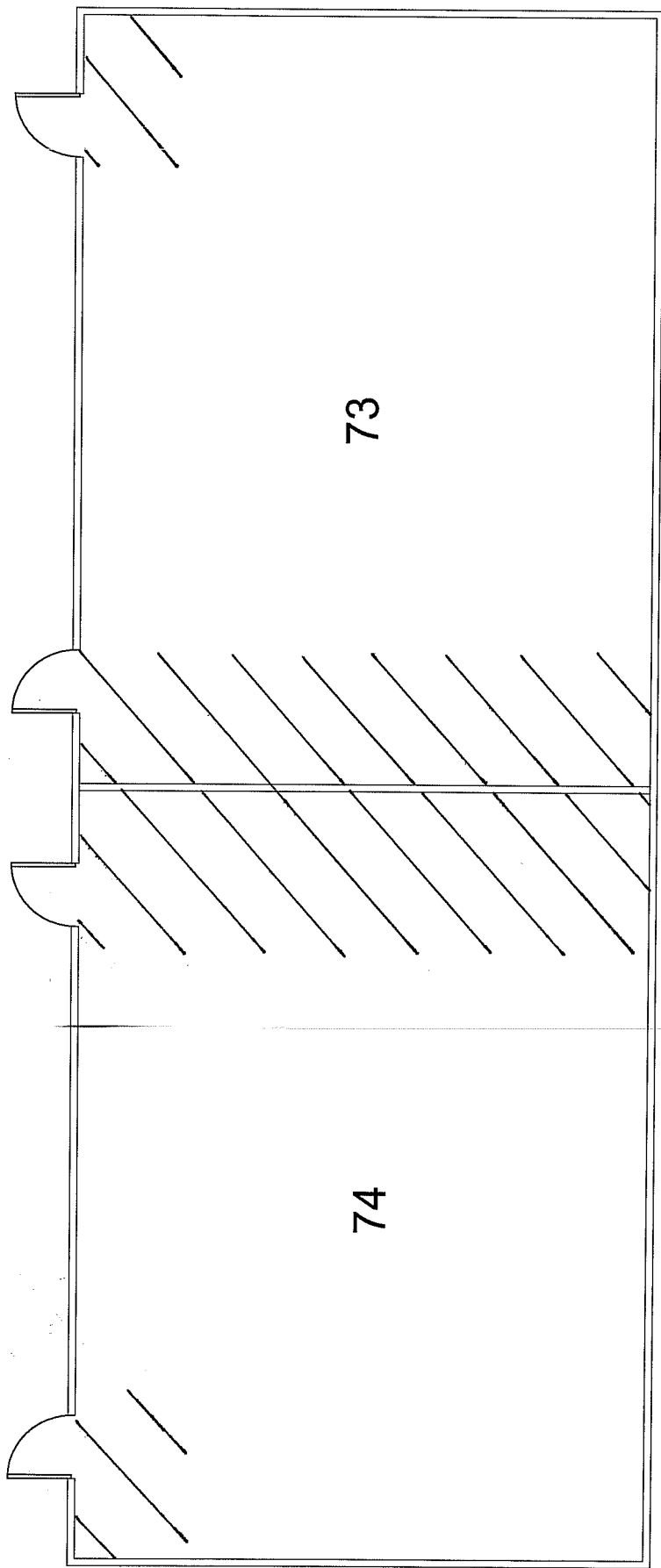

FLOOR PLAN
N.T.S.



PROJECT: AHERA ASBESTOS INSPECTION

CLIENT: KYRENE SCHOOL DISTRICT NO. 28

SITE: KYRENE DE LA ESPERANZA ELEMENTARY SCHOOL

BUILDING: PORTABLE 73/74

M-OCT-21

M-OCT-22

M-MAS-23

PROJ. NO: 08-085

DATE: 03.05.08

DRAWN BY: JGA

CHECKED BY: CR

FM GROUP INC
15974 N. 77TH STREET
SUITE 100
SCOTTSDALE, AZ 85260
Phone: (602) 277-7877
Fax: (602) 277-8288



73

74

SECTION 7

O&M PROGRAM

OPERATIONS AND MAINTENANCE PROGRAM MANUAL

Prepared For:

Kyrene De La Esperanza Elementary School

April 2008

FM Project 08-085

TABLE OF CONTENTS

<u>Section</u>	<u>Page</u>
PREAMBLE	iii
ASBESTOS MANAGEMENT POLICY STATEMENT.....	iv
EXECUTIVE SUMMARY	v

I. O&M PROGRAM POLICIES AND PROCEDURES

1	INTRODUCTION.....	I-1
2	DESCRIPTION OF AN O&M PROGRAM.....	I-1
3	TRAINING	I-5
4	EMPLOYEE PROTECTION	I-6
5	MEDICAL SURVEILLANCE	I-8
6	NOTIFICATION PROCEDURES.....	I-11
7	ACBM SURVEILLANCE AND REINSPECTION PROGRAM.....	I-13
8	EXPOSURE MONITORING	I-14
9	WORK PERMIT SYSTEM.....	I-15
10	RECORD KEEPING.....	I-16

II. GENERAL O&M WORK PRACTICES

1	INTRODUCTION.....	II-1
2	SPECIAL CLEANING.....	II-1
3	EMERGENCY RESPONSE.....	II-1
4	MAINTENANCE WORK PRACTICES.....	II-2
5	DISPOSAL/STORAGE REQUIREMENTS	II-2
6	COST ESTIMATES OF CLEANING EQUIPMENT	II-4

III. SPECIFIC O&M WORK PRACTICES

APPENDICES

- Appendix A - Record-keeping Forms
- Appendix B - Terms and Abbreviations

PREAMBLE

An Asbestos Operations and Maintenance (O&M) Program depends on several factors to be successful. Management involved with either contracted or in-house renovation/maintenance projects at this facility will constantly be posed the question "Does this material contain asbestos?". The O&M Program ideally includes the resources for all employees or contractors to contact the appropriate person for information about specific materials, which they may impact. District or outside personnel with knowledge of Asbestos-Containing Materials (ACM) or Asbestos-Containing Building Materials (ACBM) in this facility should always be involved in the initial planning phase of maintenance, remodel, renovation, and demolition projects.

A successful O&M Program must include written procedures and policies, which are respected and followed by employees and contractors. There will always be some problems because some employees and contractors simply do not care about policies and procedures and they just want to complete their work. The District needs to prepare for the inevitable cleanup and abatement following impact to ACM or ACBM by employees, or natural building system failures such as water leaks. The District should always have abatement consultants and contractors available to provide support when it is needed.

A reliable consultant is needed to help in managing in-place asbestos at a facility. The consultant can serve as a valuable resource by conducting material testing, air monitoring, work inspection, and management services.

A reliable abatement contractor will be needed to conduct small and large abatement projects associated with normal building maintenance and renovation projects. This will help in addressing estimating issues for projects and emergency responses. The contractor must be available for emergency situations and they must have a good understanding of the requirements for working at the facility. Most facilities have various levels of occupant concern and it is often necessary to take extra precautionary measures when abatement work is conducted in specific areas or buildings. An abatement contractor who conducts many projects at a facility will have a good understanding of the kind of conduct that is expected, the level of required cleanup, and specific abatement work practices.

A complete O&M Program with policies and procedures will not work if the employees are not adequately trained about what they should and should not do when they work around ACM or ACBM. An O&M Program is successful only if all employees work together to avoid situations where ACM or ACBM are impacted and fiber releases occur.

ASBESTOS MANAGEMENT POLICY STATEMENT

Kyrene School District No. 28 (KSD) shall endeavor to minimize asbestos risks to their students, their employees, and the public through proper management of ACBM in District-owned and District-controlled facilities.

Proper management includes good O&M practices, enclosure, encapsulation, and removal of ACBM as mandated and, where appropriate, as prioritized by the Kyrene De La Esperanza Elementary School (KDLEES) Asbestos Management Plan.

Each facility shall adopt an O&M Program as part of its Asbestos Management Plan. Each O&M Program must be consistent with the KDLEES's Asbestos Management Plan, and all rules and codes that apply to that facility's operation.

Each facility's O&M Program is a management tool to be followed until all ACBM is removed from that facility. O&M Programs are designed to:

- Cleanup and repair any existing contamination from past damage or disturbance until such time as the ACBM can be removed,
- Prevent further release of asbestos fibers through good work practices, and
- Maintain asbestos in good condition through an ongoing program of monitoring the condition of ACBM and repairing any damage.

Each facility owning or controlling structures containing ACBM shall coordinate and monitor all asbestos-related activities. KSD has a designated person to ensure that the policies and procedures of each KSD facility's O&M Program is followed. This person is called the "Asbestos Program Manager" (APM). The APM, with assistance from the District's Asbestos Consultant, shall develop and implement O&M Programs that comply with all relevant federal, state, and local laws.

EXECUTIVE SUMMARY

This O&M Program Manual for the KDLEES Campus at 14841 South 41st Place in Phoenix, Arizona, is a part of KDLEES's Asbestos Management Plan. Its purpose is to help assure well-reasoned control of ACBM in this facility.

The mandated goals of KDLEES's program include:

- Information documenting the presence or absence of ACBM,
- Standards for managing ACBM,
- Action to correct any immediate health hazards,
- Standards to inform and train employees, and
- Long-term commitment by KDLEES to manage ACBM.

I. O&M PROGRAM POLICIES AND PROCEDURES

1.0 INTRODUCTION

Asbestos Today

At one time there were over 3,600 commercial products that contained varying amounts of asbestos. The Federal Environmental Protection Agency (EPA) and Occupational Safety and Health Administration (OSHA) estimate that over 2,000 of the 3,600 asbestos-containing products were used in a variety of building materials.

Asbestos-containing sprayed-on insulation and acoustical materials and thermal system insulation were banned in the 1970s.

The first three steps to manage ACBM in a facility are:

- Identifying and determining the extent of the problem,
- Performing a hazard assessment on each material to determine the potential for asbestos fiber release, and
- Developing a plan to deal with the ACBM in each facility. This plan is the Asbestos Management Plan.

Once these three steps are taken, there are five options to deal with the ACBM. They include good O&M practices, repair, encapsulation, enclosure, and removal. While removal of asbestos from facilities is the only permanent option, and may be required at some point of building use (see 40 CFR 61, Subpart M, 11/20/90), it is not always the most economic option, which may protect human health and the environment. It should also be noted that any control option other than removal will result in the need for an O&M Program to maintain the ACBM which is left in the building.

2.0 DESCRIPTION OF AN O&M PROGRAM

An O&M Program is a set of policies, procedures and work practices that are intended to minimize occupant exposure to airborne asbestos fibers. The O&M Program is designed to protect workers and other building occupants who work around ACBM. An effective O&M Program will provide guidance for protection by (1) cleaning-up and repairing any existing contamination from past damage and disturbances, (2) preventing further release of asbestos fibers through good work practices, and (3) maintaining asbestos in good condition through an effective program of monitoring the condition of ACBM and repairing any damage.

All effective O&M Programs have common elements that include:

- A Policy Statement
- Training Requirements
- Employee Protection
- Medical Surveillance
- Labeling and Notification
- ACBM Surveillance
- Disposal of ACBM
- Exposure Monitoring
- Work Permit System
- Record Keeping
- Specialized Cleaning
- Emergency Response Procedures
- Maintenance Work Practices

Technical assistance to develop a complete plan may be needed from building staff, maintenance and custodial personnel, and other journeymen who may work at the facility. Architects, engineers, consultants, contractors, medical advisors, and legal counsel can also be good resources to assist in developing the O&M Program.

An O&M Program, to be useful and understandable, must be site specific for each individual building. It should address *specifically*: O&M cleaning, repair and maintenance in areas of ACBM within the building. For instance, it should not be a general statement on worker protection, but should be an ACBM specific statement on work practices and policies.

Needless to say, the O&M Program must be based on a complete and comprehensive building inspection designed to identify *all* the ACBM in a building. Only with this important prerequisite in place, will an O&M Program be successful in avoiding the potential health effects to people and resulting liability to the building owner.

The O&M Program Manual should include a summary of any existing asbestos survey information. It should include the types of material found to contain asbestos and the areas where they are found. Schematic floor plan drawings can be very helpful in this section.

2.1 Personnel Responsibilities

The success of the O&M Program depends on the active involvement and understanding of all parties. This may range from KSD administrator to the manager of the asbestos program and the school staff. Each school must ensure all asbestos-related activities are done in compliance with relevant federal, state, and local laws. In order to do this, KSD has designated a person (known as the APM) to carry out relevant laws and the policies/procedures of this O&M Program Manual.

In addition, KSD may provide support staff, including a response team, to assist the APM in carrying out his/her responsibilities. Below is a list of job responsibilities assigned to key personnel in developing and implementing the O&M Program.

2.1.1 Asbestos Program Manager

The APM, or designee, develops and implements the asbestos control program. The appropriate responsibilities include the following:

- Manage the O&M Program; document, update, and announce its activities.
- Maintain and manage the documented inventory of ACBM in its present locations.

- Participate in the development, review, and monitoring of program designs, and/or repair and alteration projects. Comply with relevant standards and laws when disturbing ACBM.
- Implement the asbestos training program(s). Participate in the development and implementation of a medical surveillance and respiratory protection programs.
- Ensure asbestos programs are documented and record-keeping activities comply with relevant laws and this O&M Program Manual.
- Seek technical direction and assistance from a qualified asbestos consultant. This may be for the program development and implementation, inspection and reinspection of ACBM, and/or personnel training.

2.1.2 Response Team Leader

- Keep an inventory of equipment and supplies.
- Check warning labels and replace them as needed.
- Coordinate and report work and emergency practices.
- Assist the APM, or designee, with his/her duties.

2.1.3 Response Team

- Conduct small-scale, short-duration asbestos removal activities.
- Conduct initial and periodic cleaning activities.
- Respond to fiber release episodes.
- Conduct or help conduct periodic surveillance activities.
- Assist the APM, or designee, and response team leader with record-keeping duties.

2.1.4 Consultation Staff

- Assist in development and implementation of O&M Program.
- Enhance the District's Asbestos Management Program through consultation.

2.2 Basic Considerations for Selecting Asbestos Abatement Contractors

Successful asbestos abatement projects demand a high level of expertise, experience, and specialized knowledge from all members of the "abatement team". As the principal "hands-on" member of the abatement team, the abatement contractor carries a large burden in fulfilling contractual obligations requiring him to successfully abate a particular asbestos hazard. This enormous responsibility, as well as an understanding of the potential consequences of an

unsuccessful project, requires a building owner to exercise his best efforts to ensure a successful completion.

A key step in the management of asbestos abatement projects of any kind is selecting the best person or company to perform a particular project. The scope, complexity, magnitude, and other particularities of any abatement project must be matched to potential contractors' abilities to successfully complete the job. Qualification of potential contractors is considered by many industry leaders to be one of the best methods to help ensure successful completion and to avoid common construction pitfalls that tend to be magnified in the highly charge atmosphere of asbestos abatement.

While no system of prequalification is foolproof, there are a number of key questions that should be asked in virtually all cases. The following are offered as some basic points of consideration when prequalifying asbestos abatement contractors; they are by no means all-inclusive.

- How long has the company been in business?
- How long has the company been actively involved in asbestos abatement contracting?
- Has the company previously done business under other corporate names? If so, what were they, and where were they incorporated?
- What projects have the company completed that are similar in size, scope and complexity to your particular project?
- What is the abatement experience of key company personnel, such as site superintendents and project managers?
- What are the educational and asbestos-specific training qualifications of key company personnel?
- Was the training of key personnel performed through in-house training programs, private training providers, or others?
- Is the company properly licensed to perform asbestos abatement work in your project's jurisdiction?
- Does the company, either under its present or past names, have any past or present regulatory citations? If so, what was the disposition of any past citations or what is the status of pending cases?
- Is asbestos abatement work covered by the Company's commercial general liability or supplementary insurance policy(s)?
- Is the insurance coverage of the occurrence, claims-made, or other form? If the policy is through a risk retention group, what is the financial status of the group and its history of paying claims?
- Is the company's bonding capability sufficient for the size of your particular project?

- Does the company have a reasonably good credit history? Does the company show an out-of-the-ordinary number of liens against it on previous projects?

3.0 TRAINING

A written plan is vital to provide step-by-step procedures and to document the intent at each facility. To implement and carry out a successful program, a well-designed training program is needed.

Training provides an awareness of the presence of ACBM, types of ACBM, consequences of disturbing ACBM, and proper work practices to minimize release of fibers. Also, training can inform personnel of existing management goals in dealing with ACBM and proper procedures in the event of an emergency.

3.1 Training Levels

A review of the three training levels which should be required for O&M Programs is provided below:

General Awareness Training

All custodial and maintenance personnel who work in a building containing ACBM should have at least two hours of asbestos awareness training, regardless of whether they intend to disturb ACBM or not. This training extends to temporary employees. All new maintenance personnel should receive training within 60 days of employment. Training topics include types and uses of asbestos, health effects of exposure, location of ACBM in each building in which they may work, how to recognize damage/deterioration of ACBM, the name and telephone number of the APM, or designee, and the availability and location of the facility's Asbestos Inspection Report. This training may be done by the APM, or designee.

Small-Scale Asbestos Worker Training

Employees who conduct any activity which may result in the disturbance of ACBM should complete an approved 16-hour training course. Topics should include the two-hour general awareness, personal protective equipment, work practices, personal hygiene, safety hazards, medical monitoring, air monitoring, regulations, hands-on training and a review. A review examination of the training may be useful as a tool to encourage study and understanding of the subjects covered.

The training for each individual should be documented as to date, location, and length of training. This documentation should be preserved in permanent files, and new employees should be trained prior to working with ACBM.

Asbestos Program Manager Training

APM's are to receive training in the health effects of asbestos exposure, detection, identification and assessment of ACBM, options for controlling ACBM, asbestos management programs, and relevant federal, state, and local laws.

It is also recommended that the APM receive training as an EPA Accredited Building Inspector, Management Planner, Contractor/Supervisor, and Project Designer.

3.2 Record Keeping

All training must be documented. Records of all training should be kept for an indefinite period of time.

Training records/forms are kept for each person who receives any asbestos-related training. A list of training records to be kept by each facility is presented below:

- Each employee receiving the two-hour General Awareness Training completes the *General Awareness Training Form*, or equivalent form.
- Each employee who completes the 16-hour training fills out a *Small-Scale Worker Training Form*, or equivalent form.
- Regardless of the training taken, the APM, or designee, completes and signs an *Asbestos Management Coordinator Training Form*, or equivalent form.
- Also, each facility should require proof of proper training for all outside contractors who handle asbestos in their building.

Asbestos Hazard Emergency Response Act (AHERA) training requirements are discussed in the EPA Regulation 40 CFR 763.84 and 763.92. All facilities covered by AHERA should review this regulation to comply with training requirements.

4.0 EMPLOYEE PROTECTION

Each facility should develop and implement an employee protection plan to ensure safe work practices for employees handling ACBM.

4.1 Respiratory Protection

Respiratory protection is required by OSHA (29 CFR 1926.1101) when air contamination levels exceed or may exceed the permissible exposure limit (PEL) as defined below:

- PEL includes the 8-hour time-weighted average (TWA) limit and the excursion limit (EL)
 - ◊ PEL is defined as 0.1 f/cc averaged over 8 hours
 - ◊ EL is defined as 1.0 f/cc averaged over 30 minutes

It is not always possible to know the exact employee exposure until after an O&M or small-scale project is done. Therefore, during initial cleaning and other O&M projects, workers are provided at least half-face, negative-pressure, air-purifying respirators. A higher level of respiratory protection may be needed for some projects. This will be decided on a case-by-case basis.

These OSHA exposure levels are compliance triggers only and have no reference to "safe" levels of exposure, nor were they intended to. They are meant only to be levels which could be easily quantified or measured and therefore, demonstrated in a court of law if need be, to enforce a variety of mandated compliance issues.

To better protect workers from exposure and protect building owners and employers from liability, the stated intent of good Respirator Protection Programs (RPP) should be to protect workers to *at least* a maximum level of exposure calculated to be 0.01 f/cc. The US EPA AHERA regulation requires that schools document a "final clearance" air sampling of less than 0.01 f/cc by Phase Contrast Microscopy (PCM) analytical methodology before an asbestos abatement work area may be reoccupied by unprotected building occupants.

Each facility should implement the KSD's written RPP to comply with relevant federal, state, and local laws.

The following OSHA regulations are mandatory as they apply to respirator use in asbestos O&M Programs:

- 29 CFR 1910.134
- 29 CFR 1926.1101
- 29 CFR 1926.1101
- 29 CFR 1926.1101 Appendix C
- 29 CFR 1926.1101 Appendix D

4.2 Personal Protective Equipment

In addition to respirators, each facility should provide and, under most conditions, should require the use of Personal Protective Equipment (PPE) such as protective coveralls, rubber boots, and gloves. Each facility also provides and requires the use of eye protection as needed. If the facility does not use disposable, single-use coveralls, they must abide by regulatory requirements for laundering contaminated clothing. These requirements include, but are not limited to, laundering clothing in such a manner that asbestos fibers are not released and notifying the person doing the laundering that the clothing is asbestos-contaminated. The clothing must be transported in properly labeled, sealed, impermeable bags or containers (see 29 CFR 1926.1101 (i)). Although the use of launderable coveralls is allowed by Federal regulations, their use is not recommended. Complete decontamination of cloth is difficult to verify.

It is strongly recommended that employees *do not* wear street or work clothes under the disposable coveralls. The first reason for this is to reduce heat stress, which is often experienced by asbestos workers. The second reason is to reduce the chance that workers' clothes transport contamination to other sites and other people. It is recommended that the workers either wear two disposable coveralls or an appropriate garment, such as slick nylon swimwear, under their disposable suit.

4.3 Decontamination Procedures

Each facility must ensure that all workers perform proper decontamination procedures following all small-scale and/or O&M projects. These procedures may include, but are not limited to:

- Vacuuming - The worker must vacuum the disposable coveralls with a High Efficiency Particulate Air (HEPA) vacuum. If a worker is wearing two suits, he/she uses a HEPA vacuum to decontaminate the outer suit and then removes it. In cases where a worker chooses to wear a slick nylon bathing suit under the disposable clothing, the worker will carefully vacuum off with a HEPA filtered vacuum and remove the disposable suit.
- Showering - The worker will proceed to a shower to further decontaminate, if required, and/or to a clean room to change into street clothing.
- Disposal - In all cases, the worker will dispose of the coveralls and gloves as asbestos-contaminated waste.
- Respirator Care - The last item a worker will remove is the respirator. Respirators are decontaminated as follows:
 - ◇ Wipe off respirator with a damp cloth prior to removal
 - ◇ Loosen straps and exhale as the respirator is removed
 - ◇ Soak filters and dispose of as asbestos-contaminated waste
 - ◇ Wash, dry, reassemble, and store the respirator

5.0 MEDICAL SURVEILLANCE

Medical surveillance is required under the OSHA Construction Standard (29 CFR 1926.1101(m)) for employees working with ACBM when:

- They are exposed at or above the action level (0.1 f/cc) for 30 or more days per year, or
- They are required to wear negative-pressure respirators.

To determine the need for medical surveillance for employees, each facility must conduct an ongoing program of air monitoring. This is to produce sufficient objective data to determine whether employees are exposed at or above the action level.

Each facility ensures that employees participate in a Medical Surveillance Program (MSP) under the situations below:

- If an employee is handling ACBM;
- If an employee, regardless of their job, meets the criteria specified by the Asbestos Construction Standard as described above; and
- If an employee, regardless of their job, meets the criteria specified by the Asbestos General Industry Standard (29 CFR 1910.1001(I)).

If an employee in the asbestos MSP terminates employment for any reason, a final medical exam will be made available within thirty (30) days of termination. No termination exam is needed if the employee has completed an asbestos examination within the previous six months. Medical surveillance shall be conducted in compliance with relevant federal, state, and local laws.

The following is an example of a written MSP which may be used to ensure compliance with the OSHA regulations, and which must be maintained on the site where the asbestos-related O&M work takes place.

MEDICAL SURVEILLANCE PROGRAM

The MSP for KSD consists of the following main elements:

- Initial Examination
- Annual Examination
- Termination Examination
- Signed Opinion by Physician
- Employee Medical Record

A. Initial Examination

As required in the OSHA Regulations (29 CFR 1926.1101 and 1910.1001), all employees who will be assigned to an occupation exposed to airborne asbestos must have an initial examination performed by a licensed physician.

A copy of the physician approval for occupational respirator use will be maintained on the jobsite and a copy of the medical exam will be given to the employee. All medical records will be filed and stored in a safe place for a minimum of 30 years.

B. Annual Examination

All employees who may be exposed to airborne asbestos shall undergo an annual medical examination, which will be the same as the initial examination, except for the OSHA questionnaire and the X-rays. The OSHA questionnaire will be the abbreviated form for use with annual examinations and the X-rays will be given every five years, except for those employees with 10+ years into the asbestos latency period and 35 to 45 years of age. This X-ray will be given every 2 years. All employees over 45 years of age must have an X-ray annually.

	<u>Years Since 1st Exposure</u>	<u>15 - 35</u>	<u>Age of Employee 35 - 45</u>	<u>45+</u>
Frequency of X-rays	0 - 10 10+	every 5 yrs every 5 yrs	every 5 yrs every 2 yrs	every 5 yrs annually

The annual signed physician's opinion on fitness for work in a respirator in an asbestos environment will be maintained on the jobsite and a copy of the annual medical exam will be forwarded to the employee. All medical documentation will be stored and kept for a minimum of 30 years.

C. Termination Examination

As per the OSHA Standard (29 CFR 1910.1001(l)(4)(i) and (ii)), KSD will provide or make available a termination of employment medical examination for any employee who has been exposed to asbestos. The medical examination will be in accordance with the requirements of the periodic or annual medical examination and will be given, or made available, within 30 calendar days before or after the date of termination of employment.

D. Information Provided to Physician

KSD will provide the following information to the examining physician:

1. A copy of the OSHA Regulation 29 CFR 1926.1101 and Appendices D, E, and I.
2. A description of the employee's duties, as they relate to asbestos exposure.
3. The employee's anticipated exposure level.
4. A description of any personal protective and respiratory equipment used.
5. Information from previous medical examinations not otherwise available to the physician.
6. Instructions to the physician not to reveal, in the written opinion given to the employer, specific findings or diagnoses unrelated to occupational exposure to asbestos, without a signed consent form from the employee.

A copy of this information will be maintained in the company files and a reference to this information will be included in the medical file on each employee.

E. Physician's Written Opinion

KSD will establish, as a part of its permanent records, a medical surveillance record on each employee. This record will be maintained for the duration of the employment, plus a minimum of 30 years. This record will be made available, upon written request, to OSHA, the affected employee, and former employees or their designated representatives. The employee medical record shall contain at least the following information:

1. The name and social security number of the employee.
2. A copy of the employee's medical examination results, including the medical history questionnaire responses, results of any tests and physician's recommendations.
3. Any employee medical complaints related to asbestos exposure.
4. A copy or reference to the information provided to the physician by the employer.

Physician information

This information is for compliance with the OSHA Standard 29 CFR 1926.1101(m)(3) and is to be used as a reference for all medical surveillance exams conducted for KSD.

1. The employee's duties shall be to work with ACBM in an asbestos abatement setting. Various job descriptions are: work area preparation, work inside the contaminated area (encapsulation, enclosure, removal), loading, transporting, and unloading of ACBM.
2. The employee's anticipated exposure level range will be from a trace (.001 f/cc) to an anticipated maximum of 10 f/cc. This exposure will vary with the tasks performed, but will mainly be below the TWA of 0.1 f/cc.
3. The PPE furnished to the employee shall be a respirator, full body covering with disposable coveralls, latex gloves and rubber boots. Hard hats will be issued when applicable. The respirator system used shall be National Institute for Occupational Safety and Health (NIOSH) approved for the work and will be well within the limits of the OSHA protection factor chart. The minimum respirator protection usually furnished by KSD is a powered air-purifying respirator (PAPR), which automatically and continually forces air into the facepiece through no effort of the employee and has the benefit of the positive pressure protection.

According to Federal Regulation 29 CFR 1926.1101(m)(4)(ii), the physician is not to reveal in the written opinion given to the employer specific findings or diagnoses unrelated to occupation exposure to asbestos.

6.0 NOTIFICATION PROCEDURES

A notification program informs employees, students, and outside contractors about the presence of ACBM in the facility. It shows the steps to take to avoid disturbing ACBM. It also informs employees about what to do and whom to contact in case of an asbestos-related emergency.

Notification of employees, students, and outside contractors can be done through letters and/or the posting of warning signs and labels. Warning signs and labels can be attached directly to ACBM or posted to alert people to a hazard prior to entering an area. It is suggested that new employees receive this information during employee orientation. "Awareness" sessions similar to those discussed in Section 3 of this manual can also be used.

Each facility shall also inform short-term workers and outside contractors who may come in contact with ACBM about the presence of ACBM in the facility in which they are working. This step is necessary to avoid the disturbance of ACBM during contracted activities.

6.1 Notification Letters

Each facility provides notification that complies with relevant federal, state, and local laws. Employees and students receive notification containing the details below:

- Presence and location of asbestos in their facility
- Content, location, and availability of the Asbestos Inspection Report and O&M Program
- Health hazards associated with exposure to airborne asbestos fibers
- Types of actions that could result in the release of asbestos fibers
- Name, location, and phone number of the APM, or designee, in the event of damage or disturbance of ACBM

All contractors and short-term workers, including the telephone company, repair and utility workers, and exterminators, shall be notified of the presence of ACBM in the facility. Upon request, the specific location of ACBM in the areas where contractors and short-term workers are working is given along with instructions not to disturb any ACBM. The APM, or designee, is consulted prior to any disturbance of ACBM. The *Contractor Notification Form*, or equivalent form, and the *Short-Term Worker Notification Form*, or equivalent form, stating that they have been informed of ACBM, should be signed by the contractor and short-term workers.

Each facility instructs the appropriate contractor that no ACBM may be installed without prior written approval of the APM, or designee. The contractor signs a statement certifying that the products they used and/or installed are non-ACM. A *Non-ACM Certification Form*, or equivalent form, shall be signed by each contractor prior to installing products within the facility. This information will save subsequent testing and sampling prior to future maintenance, renovation, and demolition projects that affect this material.

6.2 Warning Signs

Warning signs shall be posted, as required by OSHA, any time the fiber contamination level in an area exceeds or can reasonably be expected to exceed the PEL. To comply with this requirement, each facility also posts warning signs in each area during O&M activities involving ACBM. O&M activities include initial cleaning, repair, small-scale removal, and emergency response cleanup, regardless of the fiber contamination level.

Warning signs shall comply with all relevant federal, state, and local laws and must bear the following information:

**DANGER
ASBESTOS
CANCER AND LUNG DISEASE HAZARD
AUTHORIZED PERSONNEL ONLY
RESPIRATORS AND PROTECTIVE CLOTHING ARE REQUIRED IN THIS AREA**

In cases where warning signs are posted because of fiber contamination levels, each facility documents:

- The location of warning signs,
- The extent of the contamination,
- The length of time the signs were posted,
- The corrective action taken to reduce contamination levels, and
- Proof of the response action's effectiveness (i.e., air samples).

6.3 Warning Labels

Each facility should post warning labels on all mechanical systems insulation that contains asbestos. In addition, all asbestos-containing materials in routine mechanical spaces should be labeled:

**DANGER
CONTAINS ASBESTOS FIBERS
AVOID CREATING DUST
CANCER AND LUNG DISEASE HAZARD**

All labels shall be clearly visible. Labels shall be posted at the beginning and end of each continuous pipe run and at least every 75 feet. Extra labels should be required at each valve, flange, or change in direction. Each time a pipe passes through a wall, floor, or ceiling a label shall be posted on each side of the penetration.

7.0 ACBM SURVEILLANCE AND REINSPECTION PROGRAM

An important aspect of the O&M Program is visual monitoring of ACBM, done at set intervals. The purpose of the monitoring is to detect damaged or deteriorated ACBM as early as possible so that corrective action can be taken.

Custodial and maintenance personnel are instructed to observe the condition of ACBM in their area. They are also instructed to report any damaged to their supervisor and the APM, or designee, as soon as possible.

7.1 Periodic Surveillance

Although no formal training is required by regulatory agencies, it is recommended that person(s) conducting the periodic surveillance activities receive training and experience beyond the general awareness training. This may include EPA Building Inspector/Management Planner accreditation and training on interpreting the facility's Asbestos Inspection Report.

Periodic surveillance documents the condition of all ACBM by using a *Periodic Surveillance Form*. A copy of the form is submitted to the APM, or designee. The periodic surveillance should be done at least every 6 months. This may vary depending on such factors as accessibility, area use, and type of ACBM present.

Schools covered by AHERA are subject to special surveillance programs. The APM, or designee, should consult 40 CFR 763.92(b) for more details.

7.2 Reinspection

A complete reinspection of known ACBM in the facility by an accredited Building Inspector/Management Planner should be accomplished every 3 years, and the O&M Program updated at that time. This reinspection is necessary to keep the O&M Program updated as to any response actions, which may have occurred, and to address any change in the condition of ACBM, or use of the functional space, which contains the ACBM, which may indicate a new hazard in the facility.

In February 1992, EPA published a useful checklist guide for reinspections titled "A Guide To Performing Reinspection Under The Asbestos Hazard Emergency Response Act (AHERA)" (EPA 700/B-92/001).

8.0 EXPOSURE MONITORING

Air monitoring can be a useful tool to further evaluate the condition of ACBM and its potential to release asbestos fibers. Air sampling, when done correctly, may provide early warning about any deterioration of ACBM. To be meaningful, air monitoring is done over a long period of time throughout the entire building under normal use conditions.

8.1 Periodic Area Monitoring

Periodic air monitoring in a building is merely a supplement to an ACBM surveillance program. Each facility conducts periodic air monitoring in buildings with friable ACBM found in air plenums, in areas of significant air movement, and in areas with significant vibration.

Air sampling is strongly recommended on a regular basis, appropriate for the specific conditions as referenced above. The samples must be analyzed using Transmission Electron Microscopy (TEM).

8.2 Employee Exposure Monitoring

Each facility should provide an employee exposure monitoring plan to comply with relevant federal, state, and local laws. Although OSHA allows the use of objective data (see 29 CFR 1926.1101(f)) in place of actual employee air monitoring, air monitoring of employees should be done in order to better design work practices which not only protect the employee from exposure, but also protect the facility from potential contamination. The documentation which this air monitoring generates should be preserved in the permanent record in order to protect the facility owner from any future liability. Air monitoring data should be current within 12 months if it is to be used to verify a negative exposure assessment.

9.0 WORK PERMIT SYSTEM

Each facility shall implement a “work permit” program to control maintenance, renovation, and remodeling work that could result in the disturbance of ACBM. It is also recommended that a “work permit” program be designed to control other asbestos-related activities. A sample program is outlined below. If the facility contracts for asbestos-related activities, this task could be included in the bid specification and/or contract documents. The APM, or designee, may choose another person to assist in implementation and coordination.

The “work permit” system requires any person doing work impacting building materials in the facility to submit a *Job Request Form*, or equivalent form, to the APM, or designee, prior to doing any work. This form would identify the specific personnel who do the work, including outside contractors, and would describe:

- The time and location of the job in question,
- The type of job, and
- Any known information about the presence of ACBM.

Once the APM, or designee, receives the Job Request Form, the steps below are taken:

- Review data - Review the Asbestos Inspection Report and any other records to determine whether or not any ACBM will be affected by the project. If ACBM is unlikely to be disturbed, the APM, or designee, will note the presence of ACBM on the form. The APM, or designee, will instruct the proper people not to disturb the ACBM and the steps to take in the unlikely event of a disturbance.
- Visit the site - Make a site visit of the proposed work if it is determined that ACBM is present and likely to be disturbed. The site visit is done by the APM, or designee.
- Plan work practices - Comply with the O&M Program and all relevant federal, state, and local laws to minimize disturbance of ACBM. If not found in the O&M Program Manual, document the work practices to be used and add them to the O&M Program. New procedures must comply with all aspects of the O&M Program and relevant laws.
- Record information - Use a *Maintenance Work Authorization Form*, or equivalent form, and send to the proper personnel. Provide a copy to any outside contractor involved in the work.
- Revisit the work site - Visit the work site during the project. Document any observation on an *Evaluation of Work Form*, or equivalent form. Record and report changes from approved work practices and the corrective actions taken.
- Filing - Place a copy of the forms listed above in the permanent files.

This work permit system is the key to avoiding accidental exposure to workers or contamination of the facility. It is therefore essential that the APM have the authority to enforce the program.

10.0 RECORD KEEPING

The purpose of record keeping is to document information regarding each facility's O&M activities. A well-maintained and organized system of record keeping will demonstrate that the health and safety of those working or visiting each facility was not compromised.

A benefit of a comprehensive, organized record keeping program is that renovation of a facility is easier because of historical documentation. Also, the complex legal issues involved with asbestos make record keeping especially important.

Each facility should keep the following, or equivalent, records:

Activity	Records
O&M work done by outside contractors	Copy of training documents Copy of RPP Copy of MSP Final Clearance Documentation
Notification of Occupants	Copy of Notification Letter
Notification to Short-Term Workers	Short-Term Notification Record
Training	General Awareness Training Small-Scale Asbestos Worker Training Respirator Training Hazard Communication Training
Medical Surveillance	Initial Questionnaire Periodic Questionnaire Medical Exam Record Physician's Written Opinion Name and SSN of employee Employee complaint, re-exposure Copy of information to Physician

Activity	Records
Respiratory Protection	Copy of Training Program Respirator Inspection Form Fit-Test Record Copy of Respirator Protection Program
Periodic Surveillance	Periodic Surveillance Record
Reinspections	Reinspection Record and Report
O&M Activities	Job Request Form Job Authorization Form Visual Inspection Report Notification to Regulators
Emergencies	Emergency Record
Fiber Release Episodes	Fiber Release Record
Transportation of Waste	Chain of Custody Form Dump Receipts Hazardous Waste Manifest Proof of Class "C" Drivers License

Each facility also keeps records of all major abatement operations. These include enclosure, encapsulation, and removal. These records may be supplied by the asbestos consultant and/or the abatement contractor. The records below are kept as part of abatement records:

- Contract documents including specifications, Request for Proposal (RFP), and scope of work;
- Abatement contractor qualifications;
- Abatement contractor submittals, including those specified in contract documents;
- Asbestos consultant qualifications;
- Asbestos laboratory qualifications including Quality Assurance/Quality Control (QA/QC) plans;
- Results of all air samples;
- Photographs;
- Log books;
- Laboratory QA/QC records; and
- Final reports from consultant.

The APM, or designee, is responsible for keeping records. The APM, or designee, may need the assistance of clerical and maintenance staff to fulfill record-keeping duties. At a minimum, record keeping must meet relevant federal, state, and local laws.

Record	Retention
Medical surveillance	Employment + 30 years
Air sampling/employee exposure monitoring	Employment + 30 years
Training	Employment + 30 years (recommended)
Respiratory protection (inspections, fit-tests, and training)	Employment + 30 years
All other records	Employment + 30 years

Schools covered by AHERA are subject to additional record keeping requirements. The APM, or designee, should consult 40 CFR 763.94 for more information.

II. GENERAL O&M WORK PRACTICES

1.0 INTRODUCTION

Work practices in each of the three areas addressed in this section should be specific to the ACBM located in the facility, and to the functional spaces (room/area), which contain the ACBM.

2.0 SPECIAL CLEANING

All initial and periodic or additional cleaning of areas containing friable or damaged ACBM must be done with wet methods, HEPA vacuums, steam cleaners or a combination of those methods. The training program should impress on the maintenance and custodial staff the importance of *never* using conventional vacuums to clean up asbestos contaminated debris, and *never* dry sweep or dust in contaminated environments. Initial cleaning should be done in protective coveralls and respirators, with proper decontamination procedures being followed upon completion. All waste or debris should be treated as asbestos and properly disposed of. For regulatory guidance, see AHERA 40 CFR 763.91(c) and OSHA 29 CFR 1926.1101(g)(10) and (l).

These special cleaning procedures will also apply to any clean-up after an accidental fiber release episode.

3.0 EMERGENCY RESPONSE

An accidental contamination or "fiber release episode" may be addressed in one or two ways, depending on the size of the episode. For small or "minor" fiber release episodes (i.e., the falling or dislodging of 3 square or linear feet or less of friable ACBM), the custodial or maintenance people trained in the 16-hour O&M procedures may address clean-up in the following manner:

1. Turn off the HVAC system in the area.
2. Thoroughly saturate the debris.
3. Clean the area using the methods mentioned in 2.0 above.
4. Dispose of all debris as asbestos.
5. Immediately repair the damage to the ACBM.

For larger or "major" fiber release episodes (i.e., the falling or dislodging of more than 3 square or linear feet), the custodial or maintenance people trained in the 16-hour O&M procedures may only:

1. Restrict entry in the area and post signs.
2. Turn off the HVAC system.
3. Contact the accredited outside contractor or in-house emergency response team.

The clean-up of a major fiber release episode should include all the planning, special work practices (see OSHA 29 CFR 1926.1101), final clearance documentation, and record keeping of a major asbestos abatement project.

4.0 MAINTENANCE WORK PRACTICES

The user of this document should be familiar with all the major federal requirements for conducting asbestos related maintenance work (OSHA 29 CFR 1926.1101(g)(9); AHERA 40 CFR 763, Subpart E, Appendix B; National Emissions Standard for Hazardous Air Pollutants (NESHAP) 40 CFR 61.145 and 61.150 where applicable), and design his work procedures within the intent of these rules and guidelines. If more stringent safeguards are needed to protect workers and the facility, they should be researched and implemented.

An enormous amount of this research specific to O&M work procedures has already been completed by a panel of over 100 experts under the guidance of the National Institute of Building Sciences (NIBS). NIBS has produced a "Guidance Manual, Asbestos Operations and Maintenance Work Practices" which details approximately 125 O&M work procedures step by step. Also included are sections on APM and asbestos worker procedures preparatory to these work procedures. To duplicate any of this work here would be redundant and probably inadequate, as the work procedures must necessarily be specific to both the ACBM being addressed and the exposure element involved.

The APM is urged to obtain a copy of the NIBS guide and use it in the design and execution of the work to be addressed at each particular site. NIBS may be contacted at: National Institute of Building Sciences, 1201 L Street, N.W., Suite 400, Washington, DC 20005, or by telephone at (202) 289-7800.

5.0 DISPOSAL/STORAGE REQUIREMENTS

The following section explains the federal requirements for storage and disposal of asbestos-containing waste. Please consult with the state and local regulatory agencies if more stringent requirements apply.

5.1 Generator Requirements

The term "Generator" refers to the owner or operator of the facility or the owner or operator of the demolition/renovation operator or both. The generator is legally responsible and liable for the proper handling, storage and disposal of all ACBM abated from the building(s) and/or property. Refer to the NESHAP requirements at 40 CFR 61.150 for the federal requirements.

5.2 Handling of Asbestos Waste

The generator must discharge no visible emissions during collection, processing, packaging, or transportation of the waste. To accomplish this requirement, the generator must adequately wet the waste material, and seal it while wet in leak tight containers or wrapping. The containers must be labeled with the following 3 labels:

(OSHA)

**DANGER
CONTAINS ASBESTOS FIBERS
CANCER AND LUNG DISEASE HAZARD
AVOID BREATHING AIRBORNE ASBESTOS FIBERS**

(DOT)

**RQ ASBESTOS
NA - 2212**

(EPA)

Name and Address of Generator

Although not specified by federal law, 6-mil poly bags are normally used where applicable as a minimal level of compliance.

5.3 Disposal

All asbestos-containing waste should be deposited as soon as is practical at a waste site approved by the state NESHAP agency. Vehicles used to transport the waste must be marked during the loading and unloading with the following sign:

**DANGER
ASBESTOS DUST HAZARD
CANCER AND LUNG DISEASE HAZARD
AUTHORIZED PERSONNEL ONLY**

5.4 On-Site Storage

In some instances the generator cannot arrange for prompt off-site transportation of the asbestos waste. Also, it may not be economically feasible for a generator to provide transportation until substantial waste has been generated. However, there may be local regulations which govern how long the waste may be stored on-site. The limit for storing waste on-site in most states is 6 months to one year beginning on the date the asbestos waste is generated. It is advisable, but not required, to place the disposal bags in impermeable containers (i.e., steel, fiberboard, or fiberglass drums). The date of generation shall be marked on the outside of the containers. If the storage vessels are also designated for disposal, the appropriate labels must be affixed to the outside of the container.

5.5 Waste Shipment Record

A "Waste Shipment Record" must be sent with the waste transporter to the disposal site, containing the following information.

1. Work site name and address
2. Owner's name and address
3. Contractors name and address
4. Waste disposal site name, address and location
5. NESHAP authority for work site (name and address)
6. NESHAP authority for disposal site (name and address)
7. Description of materials (DOT)
8. Amount of waste shipped
9. Bill of lading information
10. Alternate waste site
11. Emergency response telephone number

12. Contractors certification
13. Transporter name, address and telephone number
14. Discrepancy noted at waste site
15. Waste site receipt of materials

If a signed copy is not received back from the disposal site within 35 days, the transporter, and/or disposal site must be contacted for information. If the signed copy is then not received back within 45 days of shipment, the local or regional EPA must be contacted in writing. All waste shipment records must be retained for at least 2 years. An example of a waste shipment records form and instructions is provided at the end of this section.

6.0 COST ESTIMATES OF CLEANING EQUIPMENT

The list below includes enough equipment for small-scale abatement jobs. Most facilities will not need this much equipment and, therefore, much of this equipment is optional. This section will not be applicable to facilities, which do not have an in-house program for small-scale abatement.

One Time Purchase	Character	Costs
HEPA vacuum	12 gallon, w/1.5" attachments	760.00 w/tools
Full-face respirator	NORTH or MSA	141.00
Half-face respirator	NORTH or MSA	18.00
Personal monitor kit	8-hrs. at max capacity	285.00
Mister - hand held	quart	1.50
Mister - with tank	3 gallon	35.00
Caution signs (plastic)	12 or more (10 x 14")	3.85
Extension cord	100 feet, 12/3 cord	32.00
Ground fault circuit interrupter		29.50
Nylon brushes		3.20 each

Disposable Materials/ Cleaning Supplies	Character	Costs
Filters: HEPA vacuum	12 gallon capacity	160.00
Paper vacuum	microfilter	7.50
HEPA respirator		2.60 each
Vacuum bags	6-mil poly, 33x50, 75/box	34.65
Wet wipe cloths	20 x 40" case of 300	N/C
Muslin	10 square yards	N/C
Cheese cloth	10 square yards	N/C
Latex gloves		.85 pair
5 micron water pump filter		3.50 each

Abatement Supplies	Character	Costs
Surfactant	5 gallons	45.00
Encapsulant: lag kote	5 gallons	40.72
lag kloth	5 gallon	75.50
Duct tape	2" case of 24	78.00
Protective disposable clothing w/hooded, zipping type booties	case of 25	36.00
6-mil polyethylene plastic bags	30x40, case of 100	41.50
Polyethylene	620c	34.50
Glove bags	44 x 60" case of 25	101.00
Razor knives		2.05 each
Wire saws		4.50 each
Scrapers		various prices
Wire cutters		12.50
Chisel rock hammer	1	20.00
Cotton canvas gloves		.75 pair

III. SPECIFIC O&M WORK PRACTICES

The following Work Practices have been excerpted from the National Institute of Building Sciences (NIBS) Guidance Manual, Asbestos Operations and Maintenance Work Practices, September 1995.

I. Manual Organization



1. Introduction

General This *Guidance Manual: Asbestos Operations and Maintenance (O&M) Work Practices* has been prepared to provide guidance on worker protection, basic O&M procedures, O&M cleaning practices, and procedures for responding to minor asbestos fiber release episodes in facilities with asbestos-containing material (ACM). This manual has been prepared by a National Institute of Building Sciences' (NIBS) committee under an assistance agreement between NIBS and the U.S. Environmental Protection Agency (EPA) and the General Services Administration (GSA). The project committee has prepared the manual following the rules of the NIBS consensus process. This process provides an opportunity for representatives from all sectors of the building community to participate in the development and approval of the document.

The NIBS Consultative Council through its Operations Committee has approved the composition of the project committee for balanced representation and expertise, and has provided oversight of the project activities to insure conformance with the NIBS consensus process and has accepted the final report of the project committee.

Scope and Flexibility The work practices described in this manual are applicable to repair, maintenance and cleaning operations where asbestos-containing material (ACM) or presumed asbestos-containing material (PACM) including thermal system insulation, surfacing, resilient flooring or other miscellaneous asbestos-containing materials are involved. The work practices are intended to assist in meeting the current OSHA regulations applicable to O&M work. Appendix I of this manual

describes the specific requirements of the OSHA Regulations relative to asbestos O&M work.

Work practices in this manual are not intended for dedicated asbestos abatement, but rather to control disturbance of asbestos during repair, maintenance, or cleaning. These activities are by nature short in duration and small in scale. The amount of ACM disturbed by any O&M activity should be limited. Projects producing more waste than will fit in a single 60 inch X 60 inch waste bag, as well work falling outside OSHA's O&M work classifications, should be performed in accordance with generally recognized asbestos control techniques, such as those described in NIBS' *Asbestos Abatement and Management in Buildings: Model Guide Specifications*. These O&M work practices are not to be used for activities requiring abatement of ACM.

This manual is intended for use by a designer of an asbestos O&M program, which will be implemented by an Asbestos Program Manager (APM) and trained workers. The APM may design the program as well as implement it. The title "Asbestos Program Manager" is used throughout, however, other titles can be used by individuals holding similar responsibilities.

The manual provides checklists and step-by-step work practices which might be used by an O&M program designer to develop facility specific work practices for workers performing O&M work. Because asbestos in buildings is present under widely varying circumstances including, but not limited to, its condition, location, material type, friability, and accessibility, a range of guidance for common operations and maintenance procedures is offered in this manual. The

project committee determined that flexibility is crucial to the efficient and cost effective completion of an O&M activity. This leaves the ultimate choice of methods to on-site personnel who have first-hand knowledge of the asbestos material, facility conditions, and other pertinent needs. These work practices were written with the knowledge that there might be alternate procedures or equipment beyond those in this manual that will adequately accomplish O&M objectives. The project committee encourages the development and application of new and innovative equipment and safe, cost effective procedures for O&M work.

The work practices included in the manual are based on practices known to the committee. Many of these work practices were in use when the manual was written. However, exposure data is not available for many of the work practices. During development of work practices for a facility the program designer will need to perform an exposure assessment for each work practice. Generally, this exposure assessment will involve exposure monitoring. This monitoring is necessary to comply with OSHA requirements, and to demonstrate compliance with the O&M program's goals for airborne asbestos exposure if more stringent than OSHA. Exposure monitoring may not be necessary if there is already sufficient data available for a negative exposure assessment as required by OSHA (For example, see section R, "Resilient Flooring Work Practices"). Also, initial monitoring may not be required for housekeeping activities governed by the general industry standard (1910.1001) where a determination has been made that the activities are not reasonably expected

to result in exposures at or above the TWA permissible exposure limit and/or excursion limit (refer to Section VII Resilient Flooring and Appendix I regulations for more information). The work practices in this manual are not the only successful methods currently available or in use, but were judged by the committee to be applicable to a wide range of common situations. Preventative measures that provide protection for undamaged ACM might be installed in conjunction with the O&M activities covered by this manual. A feedback form is included in Appendix J to allow users to provide alternate work practice procedures and comments to NIBS.

Different recommendations, referred to as levels, of the same work practice are provided to give examples of different levels of effort that can be applied to a given task. This may be necessary to accommodate for variations in the type and condition of the ACM to be worked on, the building conditions in which the ACM is located, the skill level of workers, and the exposure goals of the O&M program. It is assumed that varying conditions will necessitate different work practice levels to accomplish the same basic task. Selection of the appropriate levels upon which to base facility specific work practices should be made by the O&M program designer for each specific material based upon the conditions effecting that material. In addition, generally accepted good construction work practices should be used for all aspects of O&M activities. Risk assessments and liability concerns might also influence the selection of the level for a specific work practices.

Assumptions The manual has been developed on the assumption that, at a minimum, all asbestos O&M work will be done in accordance with applicable regulations by persons with a general training in managing asbestos and O&M methods in particular. It is important to emphasize that this is a guidance document only, and is not now, nor ever intended to be used for regulatory purposes. This manual is not intended to supplant work practices already in place and being successfully applied.

Likewise, it must be emphasized that users of this manual are expected to modify (in compliance with applicable regulations) the guidance provided here to suit their unique circumstances. For example, as stated elsewhere, the forms included in the manual must be modified to accommodate the operations and circumstances of the specific facility. Work practices will need to be updated based on data from past work, new equipment developments or other unique situations. This manual offers guidance only. The user must verify the success of whatever work practices are used. The development of innovative and creative new equipment and procedures that work safely and effectively for performing O&M activities is encouraged.

EPA Green Book This manual is intended as a companion volume to the guide *Managing Asbestos in Place* ("Green Book") issued by the EPA in July, 1990. The *Green Book* explains the objectives and administrative procedures for an O&M Program. This O&M Work Practices Manual provides the basis for development of detailed procedures for

conducting O&M work involving ACM, such as maintenance, repair and minor renovation work. Information presented in the Green Book is not repeated in this guide but is referenced where appropriate.

Statutory & Regulatory

Requirements There are a number of federal regulations that must be complied with during O&M operations. State and local regulations, which might be the same as, equivalent to, or more stringent than federal regulations, might also apply. These will influence the design of the O&M program and the O&M work procedures. This manual deals only with federal regulations. The O&M designer and APM must determine the effect of state and local regulation. The major federal regulations that effect O&M work are listed below and discussed in more detail in Appendix I.

1. OSHA's asbestos construction and general industry, construction safety, personal protection and hazard communication standards
2. National Emission Standards for Hazardous Air Pollutants (NESHAP)
3. Asbestos Hazard Emergency Response Act (AHERA)
4. Asbestos School Hazard Abatement Reauthorization Act (ASHARA)
5. EPA Worker Protection Rule (WPR)
6. Department of Transportation's hazardous waste transportation standards

EPA Guidance Documents

1. Asbestos in Buildings: Simplified Sampling Scheme for Friable Asbestos Materials ("Pink Book")
2. Guidance for Controlling Asbestos-Containing Materials in Buildings ("Purple Book")
3. A Guide to Respiratory Protection for the Asbestos Abatement Industry ("White Book")

A list of references, including the regulations and guidance documents listed above, is given in Appendix G of this manual.

2. Elements of an O&M Program

The overall frame work for an asbestos O&M program is described in the EPA guidance document "*Managing Asbestos in Place* (Green Book)." Operationally, an asbestos O&M program consists of administrative procedures which cause specific work practices to be used for maintenance work on asbestos-containing materials (ACM). This manual contains suggestions for work practices to be used in such an O&M program. To insure that the work practices are applied as intended it is necessary to set up an administrative frame work. This frame work need not be complex. In fact, the more simple and straightforward the administration of the program, the more likely it is that it will perform reliably. There are several elements necessary for a successful asbestos O&M program.

Definition of Scope Before the program can begin, the type, locations and condition of ACM to be controlled by the program must be determined. This can be accomplished by an inspection, or by presuming that all materials suspected of containing asbestos are indeed asbestos-containing. Unless an inspection is performed and the materials are determined not to contain asbestos, OSHA requires that all thermal system insulation, sprayed or troweled on surfacing materials, and resilient flooring material installed no later than 1980 be presumed to contain asbestos. In addition, OSHA requires that materials known to contain asbestos, or that should have been known by exercise of due diligence, also be identified. The Asbestos School Hazard Abatement Reauthorization Act (ASHARA) requires that all inspections

of commercial and industrial buildings as well as schools be performed by an EPA-accredited asbestos inspector. (The accredited inspector requirement does not apply to visual or physical examinations of resilient floor covering material when conducted as part of the process of replacing an existing floor where the material has not been sanded, ground, mechanically chipped, drilled, abraded or cut.) The first step in the initiation of an asbestos O&M programs is the preparation of an inventory of ACM or presumed asbestos-containing materials (PACM).

Policy and Organization To insure success, there needs to be a formal decision at the topmost level of management adopting the asbestos O&M program as a matter of policy. This gives the program legitimacy within the organization and insures that the asbestos program manager (APM) will be given adequate authority to implement the program. A specific administrative position must be given the responsibility for the asbestos O&M program. It is best if this position already has the authority necessary to implement the program. This position must have effective control over activities that could impact on the ACM in the facility. At a minimum, this position needs to have control over internal maintenance and cleaning personnel, outside maintenance contractors and renovation projects. In most organizations this person is the head of buildings and grounds or the facilities manager. Otherwise well conceived control programs have failed because the administrative position implementing

them had inadequate authority. This most typically occurs when the safety department is given the responsibility, but not given adequate authority.

Program Administration There will already be administrative controls in place for other purposes over internal and external personnel working on a facility. It is usually a simpler matter to add to or slightly modify these existing controls than to invent and administer entirely new ones. For example, if a facility uses a work order system, work orders for work on ACM could contain a notification about the ACM and reference to the appropriate work practice. Standardized purchase order forms for outside maintenance work on asbestos-containing installations can be developed. The issuing of work orders and purchase orders can be handled in the same manner and by the same people already involved in non-asbestos facility maintenance. The forms provided in this manual give examples of the kinds of information usually required for an asbestos O&M program. These forms should be freely modified and adapted to existing paperwork systems.

Documentation Questions can arise about regulatory compliance or program effectiveness. This can result from a visit from OSHA or the EPA; or questions from staff or their collective bargaining agents. It is useful if the administration of the program is set up so that it generates documentation to respond to these questions. A documentation system does not need to be elaborate. It simply needs to keep the work orders, purchase orders, exposure monitoring and air testing results in a common location.

Usually documentation will be needed for the following:

Program Operation: The activities of the program should be documented. These include documentation of the use of work practices, personnel, areas and systems involved.

Program Effectiveness: The level of consistency with which control methods are used should be documented. The level of isolation provided to controlled areas should be documented. Air sample results collected during work and background air sampling conducted on a periodic basis to document the overall effectiveness of the control methods used should be maintained.

Material Inventory: At the beginning of the program, an inspection should be conducted, resulting in an inventory of ACM or PACM. During the course of the asbestos O&M, a great deal of detail concerning the location and condition of these materials will be generated as work is performed. This information should be integrated in the ACM inventory. As ACM is removed the inventory should be updated. This will prevent the unnecessary expense of applying controls to non-ACM.

Regulatory Compliance: The building owner is required to comply with OSHA, EPA NESHAPS, and perhaps state and local regulations. The documentation should be adequate to demonstrate compliance with all applicable regulations. OSHA specifically requires maintenance of the following records: objective data, if relied on; exposure measurements; medical surveillance; training records; evidence used to rebut

PACM; and required notifications.

The documentation is used to evaluate and improve the O&M program. To be effective, the system of documentation should grow out of existing procedures. For example in a facility that uses a paper work-order system, if different colored work-orders are used for asbestos O&M work, it is possible to tell at a glance if O&M procedures were applied to all work on ACM.

Controlled Areas, Systems The basic administrative method of implementing an asbestos management program is to establish controlled areas and systems. These are areas or systems that are to be accessed or worked on only with the proper controls. These controls consist of specific work practices applied by trained personnel.

Controlled Areas: Where ACM is in an area to which access can be controlled, disturbance of the ACM can be avoided by controlling this access. The area is designated as "Controlled." Only individuals with the proper training are allowed access into the "Controlled Area." This training can be as simple as awareness training that informs a worker about the location of the ACM and instruction to avoid contact with it. In some instances entry into the controlled area may require specific work practices to protect the workers and the building environment. Examples of controlled areas include: spaces above suspended ceilings where there is asbestos-containing fireproofing or pipe insulation, and mechanical areas with ACM where access is limited to personnel that have been trained. A sign should be posted at

the entrance to all mechanical rooms/areas which contain ACM or PACM. The sign should identify the materials present, their location, and appropriate work practices to ensure that the material will not be disturbed. This sort of signage is required by the OSHA construction standard (29 CFR 1926.1101(k)(6)) which governs most O&M maintenance activities (see Appendix I for more information on OSHA requirements).

Controlled Systems: Building systems that contain asbestos should be designated as controlled systems. Examples include: fireproofing that contains asbestos that is sprayed or troweled on structural members, pipe insulation fabricated from materials that have been identified and inventoried as containing asbestos, equipment insulation on boilers, breechings, tanks, converters and related equipment that has been identified as containing asbestos. Contact with a "Controlled System" should be allowed only for individuals with the proper training. If the ACM is intact, non-friable, encapsulated, or enclosed, this training can be as simple as awareness training that informs the individual about the locations of the ACM and instructions to avoid disturbance of it. Work that involves the disturbance or potential disturbance of ACM requires specific work practices (such as those in this manual) applied by individuals with adequate training. The OSHA construction standard, which governs most O&M maintenance activities, requires that, where feasible, labels be affixed to notify employees about ACM or PACM (29 CFR 1926.1101(k)(8)(vii)).

Work Practices Specific work practices are used to enter a controlled area or work on a controlled system. These procedures are designed to protect workers and control the release of airborne asbestos, material and debris when the area or system is disturbed. To be useful, the work procedures must be simple and quick enough to permit practical maintenance of the building. This manual contains a number of work practices that are thought to be useful for asbestos O&M programs. In addition, the National Institute of Building Sciences *Model Guide Specification for Asbestos Abatement & Management in Buildings* contains procedures in specification form for contracted O&M work.

O&M programs should always emphasize the use of careful handling to avoid unnecessary disturbance of asbestos; and wetting, local collection and local exhaust, etc. to control disturbance of ACM. Work procedures, or modifications to these work practices, should be designed in accordance with the airborne asbestos goals of the owner and/or employer, the circumstances of the particular building, and the skill and training of the APM and workers.

Work practices need to be designed for the particular circumstances of a facility. The effectiveness of the work practice in protecting workers and the environment needs to be demonstrated through exposure monitoring. Typically, a work practice will be tested and exposure monitoring collected. The work practice should be modified and retested until it reaches the exposure goal of the facility.

Training The program should be set up so that only trained workers contact asbestos containing materials. The necessary training for activities that should contact asbestos includes not only classroom training but also hands-on training specific to the work to be performed. All workers who could contact or disturb ACM should receive awareness training and be advised to avoid disturbance of ACM and PACM. The Asbestos Program Manager who administers the O&M should be trained as required for a competent person and inspector. Refer to Appendix I "Regulations" for more information on training requirements.

The amount and content of worker training must meet OSHA and EPA minimums and should correspond to the type, condition and quantity of ACM that the custodial and/or maintenance staff will encounter in the course of their work. Training should emphasize hands-on methods. The workers should learn how to use the O&M plan as well as to perform specific tasks. In addition to specific work practices, there are general subject areas that all O&M training should include, such as personal protective equipment and respirator training where applicable, the health risks associated with asbestos exposures, and the vital importance of carefully adhering to building O&M programs. State and local regulations may also impose training requirements for O&M activities and these requirements may differ from and some may be more stringent than the federal requirements.

The APM should have training sufficient to perform inspections and identify where

asbestos will be encountered; assess the condition of ACM; evaluate potential exposure; understand building components, building systems, and building usage patterns; administer O&M activities; be familiar with cleaning and maintenance tasks; understand applicable laws and regulations; and be aware of other crucial factors associated with an O&M program. The APM in a school, commercial or public building who will be inspecting for ACM must be trained and accredited as required by AHERA (40 CFR 763 Appendix E to Subpart C. At I.B.3).

The direct supervisor of O&M workers needs to be a Competent Person as defined by OSHA. See Appendix I "Regulations" for information on training requirements for competent persons. In addition the general requirements for a competent person specified in the OSHA regulation (29 CFR 1926.32) must be met. If the O&M program involves mini-enclosures, the competent person should also have asbestos abatement worker training. Under the general industry standard, a competent person is not required for activities such as housekeeping.

The AHERA regulation for schools includes required O&M training and outlines a minimum training program. EPA recommends this training for all O&M workers.

Most O&M activities in this manual are governed by the OSHA construction standard. This standard contains minimum training requirements for construction workers (including those involved in O&M activities) based upon the class of work involved. Minimum

training requirements are set forth for workers involved in Class I work (the removal of asbestos-containing thermal systems insulation (TSI) or surfacing ACM), Class II work (removal of other ACM), Class III work (repair or maintenance activities that may disturb ACM), and Class IV work (maintenance and custodial activities that contact ACM or involve clean-up of ACM). OSHA also has minimum training requirements for the competent person that supervises each class of work. Additional training beyond OSHA requirements might be desirable for some types of O&M work.

Communications: The owner of a building is required by OSHA to make notification to the following employers about the presence, location and quantity of ACM or PACM:

- Prospective employers applying for or bidding for work,
- employees of the owner,
- all employers on multi-employer work sites,
- tenants occupying areas.

This notification is required if these employers or their employees will be performing work in or adjacent to areas where ACM or PACM is located.

Maintenance Workers: The obligation to notify extends beyond those employed by the owner and includes anyone who may disturb or contact these materials. Maintenance workers (whether directly employed by the owner or by a maintenance contractor), building occupants, contractors and those working for contractors are all included. The owner is obligated to notify contractors working on his building. These contractors are then responsible for

notifying their employees.

The building owner is required to notify affected employees of the existence of ACM which they may disturb during the course of their employment. OSHA explicitly requires a building or facility owner to locate and identify these materials.

Occupants: Experience has demonstrated that the best way to deal with building occupants is to be absolutely frank about the asbestos in their building and what is being done to control it. The communication should begin when an inspection is commissioned and continue as long as ACM remains in the building. Attempts to hide or minimize asbestos control work creates an atmosphere of distrust. An explanation of the efforts being expended to insure the well being of building occupants is usually well accepted. People react well when management cares enough to protect them. The program should be explained in this light.

If there has been an episode where ACM has been released into the building environment, the people affected may be justifiably concerned. This concern is a perfectly reasonable reaction from people who are concerned for their well being, and should not be treated as hysteria. Detailed and accurate answers should be given to all questions. Ultimately, logic and calm will prevail for the great majority of people. First, however, people need to know that they are being listened to and taken seriously.

In-house Personnel The asbestos O&M program needs to include control

over in-house personnel such as cleaning and maintenance staff that may come in contact with ACM. There should be clearly defined limits on the type of procedures performed and amount of material that in-house personnel are allowed to work on. In general, it is better to limit in-house personnel to work practices that they will be routinely performing. If an activity is seldom encountered, it is easy for a worker to forget the details of the needed procedures. These activities might better be left to a contractor experienced in the removal of asbestos-containing materials. For example, some asbestos O&M programs restrict in-house personnel from any activity that might disturb asbestos, and contract this work out to an asbestos abatement contractor. Frequently, in-house personnel are limited to those activities that can be performed without entering into an environment where there is an elevated level of airborne asbestos. The direct supervisor of workers involved in work on ACM needs to be a competent person as required by OSHA (see Appendix I "Regulations" for more information).

Contractors The asbestos O&M program should include control over contracted services.

Custodial work: Contractors involved in cleaning and other custodial services which are in the vicinity of but do not disturb asbestos containing installations, debris or dust should be notified of the location of ACM. This notification should be signed by the contractor who employs the workers and returned to the owner for documentation of the notification.

Repair and maintenance: Repair or maintenance in controlled areas or on controlled systems must involve specific work procedures using trained workers. The NIBS Publication, *Model Guide Specifications for Asbestos Abatement and Management in Buildings*, contains detailed information on contracting this type of work. Detailed specifications can also be developed from the work practices in this manual. specifications can then be attached to a purchase order or made part of a set of a contract documents.

A convenient method for acquiring outside contract services is by use of an annual service contract for the asbestos O&M services. Unit prices can be established for each work activity based upon specified work practices. Pricing for an O&M activity can then be determined by applying the unit price to the quantity of work performed. For example, there may be a unit price for removal of pipe insulation using glovebags. The cost of the work can be determined by multiplying the cost per glovebag removal by the number of glovebag removals performed. The owner can bid this contract on an annual basis. This permits the owner to acquire the required services quickly when needed and still have competition control costs.

A contractor is liable for the safety of those working for him. However, the contract between the owner and contractor if improperly drawn can transfer part of this liability to the owner. This frequently occurs due to work specifications that attempt to be over-protective or insure OSHA compliance without adequately

defining the role of the contractor as the protector of his employee. If, for example, the specification called for worker protection or respiratory protection procedures to be approved by the owner this can effectively transfer some of the responsibility for the effectiveness of these measures to the owner. The owner is responsible for notifying the contractor who is in turn responsible for notifying his employees. The standard procedures for contracting maintenance services should include submittals from the contractor to the owner demonstrating compliance with worker and respiratory protection requirements. The designer of an O&M program that is going to contract out asbestos control work should review the discussion in the introduction to the NIBS *Model Guide Specifications for Asbestos Abatement and Management in Buildings*, on owner, designer and contractor liabilities.

Audit and Review The entire program should be critically evaluated at periodic intervals. This evaluation should consider: success of work procedures, effectiveness of administrative controls, adequacy of documentation, compliance with current regulations, level of personnel training, equipment condition. This audit should be carried out by an individual or agency external to the program. This can be accomplished by another division of the organization or an outside consultant. If the audit is performed by the program designer then it becomes an opportunity to evaluate new situations, and augment worker training.

3. O&M Work Practices

General The EPA Green Book provides building owners, managers, workers and other building staff with basic information on how to develop and carry out operations and maintenance programs.

The O&M work practices in this manual are intended as the basis for the development of detailed and specific guidance to the O&M personnel for conducting maintenance, repair and minor renovation work in accordance with an established asbestos O&M program and applicable regulations. The work practices in this manual are designed to reduce or contain materials, dust, or fiber release resulting from work performed on or near asbestos-containing materials (ACM). The work practices are also intended to minimize the extent and impact of any releases which do occur. Summaries of each work practice and examples of typical situations that might be encountered are included to assist in the selection of appropriate work practice levels.

This manual presumes that an O&M program is, or will be, established. The work practices in the manual address most commonly encountered operations and maintenance tasks involving ACM. This manual is not exhaustive and does not document or establish a defined procedure for every possible situation. The manual is formatted to present an array of actual conditions which might be encountered. It establishes a logical

path to be followed in selecting the most appropriate work practice(s) for a given situation. Building workers are often very familiar with actual building conditions and might provide valuable input to the design of O&M work. Workers might also wish to offer suggestions for modifications to specific work practices. Any changes to the work practices should be reviewed with the APM.

As a part of the O&M program, the Asbestos Program Manager (APM) should review building inspection information to determine whether or not a material that is to be included in the O&M contains asbestos. If a material which potentially could contain asbestos is to be worked on, but has not been sampled, it should either be sampled and analyzed in accordance with the EPA Pink and/ or Purple Books, or be presumed to contain asbestos (PACM) and treated accordingly. The OSHA regulation (29 CFR 1926.1101) requires that a building or facility owner determine the location of ACM and PACM before any work is begun.

If work practices based on this manual are incorporated into an existing O&M program, the entire O&M program should be reviewed and updated, if necessary. Building renovation, maintenance or repair work that does not directly affect ACM might necessitate revisions to an O&M program if pertinent factors, such as accessibility to ACM, are altered.

O&M Program Assumptions

This O&M Work Practices Manual assumes that all elements of an O&M program listed below are considered and applicable elements are established. References to related information are included in Appendix G.

- Asbestos Program Manager appointment and training
- Building inspection and assessment
- Written building-specific O&M program
- Copies of applicable regulations and guidance documents
- Occupant notification/communication program
- O&M worker, supervisor, and competent person assignments and training program
- Work control/inspection/permit system
- Periodic surveillance program
- Record keeping program
- Hazard communication program
- Worker protection program (personal protective equipment)
- Respiratory protection program
- Medical surveillance program
- Asbestos fiber release episode response program
- Air monitoring program
- Waste disposal program
- Historical air monitoring data
- Confined space program
- Safety program for other hazards

All O&M related programs should be reviewed periodically and revised if necessary. Regulatory and guidance documents should also be reviewed periodically to ensure that they are current.

Organization of Work

Practices The O&M work practices in this guide are grouped according to the type of ACM that will be affected by the work. ACM is classified in this manual according to the three (3) categories used by the EPA. This classification system has been widely used in the asbestos industry since the publication of the Asbestos Hazard Emergency Response Act Rules (AHERA) in 1987. These categories are:

1. Surfacing Materials - materials sprayed or troweled onto building surfaces, such as acoustical materials or fireproofing. Drywall systems are not considered as Surfacing Materials.
2. Thermal Systems Insulation (TSI) - pipe, boiler, tank, duct and other insulation applied to components to reduce heat loss, heat gain or condensation.
3. Miscellaneous Materials - materials such as floor tile, ceiling tile, roofing, cement asbestos products, felt, woven asbestos products, and other materials that are not included in categories 1 or 2 above.

The work practices in this manual are generally designed to address one material at a time. If more than one type of material is involved, work practices should be selected and used in the order in which the materials will be encountered during the work. If two (2) or more materials must be addressed at one time, the O&M designer should develop a combined Work Practice to

address the particular work situation.

When developing a combined work practice, the O&M designer should consider the following:

1. The checklist for the *most precautionary level of work practice* should be used.
2. The work area should be prepared in accordance with the checklist for the *most precautionary level of work practice* being used.
3. Once the work area is prepared and pre-work activities are complete, the detailed work practices should be performed in the order in which materials are encountered.
4. Clean up and tear down procedures should also follow the *most precautionary level of work practice* being used.

Work practices in this manual are intended to be the basis for development of facility specific work practices. The work practices in this manual need to be modified and validated for the facility where O&M work will be performed. When work is to be performed, the final work practices should be given to workers along with other referenced O&M forms. Repetition of certain steps in different work practice levels is intentional in order to provide consistent and complete information to a worker for a given work practice level.

Work Practice Levels The NIBS project committee judged that up to three levels were sufficient to encompass a broad range of situations which are likely to be encountered. The levels are simply a means of structuring the guidance which the manual provides. Up to three levels are included for each work practice to address different degrees of potential asbestos fiber release. A different number of levels might be selected by an O&M designer or designed into a specific asbestos O&M program.

A change of level does not imply a different task to be accomplished. It implies a changed potential for asbestos fiber release, typically related to either the condition of asbestos, nature of the work practice, skill of the workers or the building context in which the task will be performed.

The levels for each work practice included in this manual are defined principally in relation to the OSHA asbestos standards. There are three standards that may apply. The OSHA construction standard, 29 CFR 1926.1101, applies to most O&M activities, including cleaning that is associated with construction. Normal cleaning, that is not associated with construction or other O&M work, including cleaning and buffing of resilient flooring, is covered by the OSHA general industry standard, 29 CFR 1910.1001. Work on ships or in shipyards is covered by the shipyard standard, 29 CFR 1915.1001. The shipyard standard is similar to the construction standard, and will not be discussed separately in this manual.

The OSHA construction standard sets forth four classes of construction-related work. Operations and maintenance and cleaning activities connected with construction work are defined as Class III and IV work. The principal difference for O&M activities is that Class III work disturbs the ACM and Class IV only contacts, but does not disturb the ACM. This manual also contains some work practices that can involve housekeeping operations which are subject to either the OSHA construction or the general industry standard.

Activities that are not intended to contact ACM and are not likely to disturb ACM are not given a level designation, but require control to insure that a disturbance does not occur.

Areas where ACM is located and where access can be controlled should be designated as "Controlled Areas." ACM systems in the vicinity of work but which do not need to be contacted should be designated as "Controlled Systems." Exposure monitoring is not required for these activities as ACM is not being contacted. Awareness training is needed to inform workers about the location of the ACM, and to advise them to avoid contacting it, and to report any damaged ACM they observe.

In general, an O&M program is easier to implement and is more cost effective if maintenance work can be performed without the need for enclosures. Maintenance work that contacts or disturbs ACM is governed by OSHA. To be able to perform maintenance work governed by the Construction

Standard (1926.1101) without an enclosure and still comply with OSHA, it is necessary to make a negative exposure assessment (NEA). This effectively makes the OSHA PEL a limit on the level of airborne asbestos that can be generated by a work practice before enclosure is required. In general, Level A and B maintenance activities related to construction are un-enclosed and as such require a negative exposure assessment. Level C work practices are enclosed and as such may generate airborne fiber levels above the OSHA PEL. The method of making a negative exposure assessment for most O&M activities is discussed in more detail in section 4 of this manual. Negative exposure assessment for resilient flooring removal is discussed in the introduction to the Section R "Resilient Flooring Work Practices." Note that a negative exposure assessment alone does not eliminate the requirement for respiratory protection. Respiratory protection is required, even with an NEA, if ACM is removed in a non-intact state, if wet methods are not used, or for removal of TSI or surfacing material. Intact is defined by OSHA as ACM that has not crumbled, been pulverized, or otherwise deteriorated so that the asbestos is no longer bound with its matrix.

Cleaning work not related to construction or dust and debris generated by such activity is governed by the OSHA General Industry Standard (1910.1001). This standard does not contain provisions for a negative exposure assessment. Routine cleaning activities are performed as Level A based on a determination having been

made that cleaning activities using the work practices in this manual (which are based on those contained in the OSHA regulation) are not reasonably expected to result in exposures exceeding the PEL.

Definition of Work Practice

Levels The three work practice levels are defined as follows:

Level A: is work that may contact ACM, but which will not disturb it. Level A is defined in terms of Class IV work in the construction standard (29 CFR 1926.1101). It is Class IV work (except for cleanup work) with a negative exposure assessment which involves maintenance and custodial activities during which employees contact ACM and PACM, but do not disturb it. **Note that clean up of asbestos-containing debris and waste is not Level A work (Refer to Level B for this type of clean up work).** It is also Class II work (involving non-friable materials such as gaskets, roofing, and cement asbestos board) with a negative exposure assessment. Work on resilient flooring is treated differently by OSHA and is described in Figure 2 "OSHA Requirements for Work Practices for Resilient Floor Covering Materials."

Work practices: required for Level A are those set forth in paragraph (g) (10) of the OSHA asbestos construction standard for Class IV work and (g)(8) and (g)(11) for Class II work. See Figure 1 for checklist of requirements

Level B: is work that may disturb ACM, but where the OSHA PEL is not exceeded and release of ACM, dust and debris is confined to the immediate location of the disturbance. In the construction standard, it is Class III work on TSI or Surfacing ACM with a negative exposure assessment, Class IV work activities to cleanup waste and debris containing ACM and PACM with an NEA. Class III asbestos work includes repair and maintenance operations, where ACM, including thermal system insulation and surfacing material, is likely to be disturbed. Operations where TSI or surfacing are worked on using "aggressive" methods, such as drilling, cutting, abrading, etc. are Level C work, as OSHA requires area isolation for these procedures whether or not a negative exposure assessment is made. In the general industry standard, clean up of ACM waste, debris and accompanying dust that are not from construction activities, and where the PEL is not exceeded is Level B work. If the quantity of material disturbed during Class III work exceeds one 60 inch x 60 inch glovebag or waste bag, then the activity becomes Class I or II and exceeds the limitation of the work practices in this manual. Refer to the NIBS manual *Model Guide Specifications, Asbestos Abatement and Management in Buildings* for more information.

Work practices: required for Level B are those set forth in paragraph (g) (9) of the OSHA construction standard for Class III work and (g)(7, 8 and 11) for Class II work. These include O&M training, respirators, engineering controls and work practices, wet

methods, local exhaust ventilation (Note: A respirator is not required if work is on non-TSI or non-surfacing material, there is a negative exposure assessment, wet methods are used, and the material remains intact). In the construction standard, asbestos-containing debris and waste from construction activities (including O&M) are to be promptly cleaned up and disposed of in leak-tight containers. The general industry standard covers clean up of non-construction waste, debris and accompanying dust. These must be cleaned up with wet methods and HEPA vacuums. The construction standard requires that in areas with accessible, friable TSI and surfacing material, waste or debris must be presumed to contain asbestos. See Figure 1 for checklist of requirements.

Level C: is work where ACM is disturbed and the PEL may be exceeded or ACM, dust, and/or debris may be scattered beyond the immediate location of the disturbance. It is Class III work described in the OSHA construction standard: paragraph (g)(9)(iii) where the disturbance involves drilling, cutting, abrading, sanding, chipping, breaking, or sawing of thermal system insulation or surfacing material; or (g)(9)(iv) where there is no negative

exposure assessment or where the PEL is exceeded. It is also Class II work without an NEA.

Work practices: required for Level C are mini-enclosures, glovebags and other enclosure devices set forth in paragraph (g)(5) of the construction standard as well as work practices set forth in paragraph (g)(9) of the OSHA construction standard for Class III work. These include O&M training, respirators, engineering controls and work practices, wet methods, and local exhaust ventilation. Debris and waste are to be promptly cleaned up and disposed of in leak-tight containers. See Figure 1 for checklist of requirements.

A "disturbance" of ACM, as used in the level definitions, refers to any activity that disrupts the matrix of ACM or PACM, crumbles or pulverizes ACM or PACM, or generates visible debris or dust from ACM or PACM..

Figure 1 which follows, summarizes the engineering controls and practices recommended for each level. The APM should determine the appropriate level, based on the O&M program objectives, the O&M program elements, and level of training needed for each level of work practices used in a facility.

Figure 1: Guidelines for 3 Levels of Work Practices
(See Figure 2 for Resilient Flooring)

<i>ITEM (General Procedure Reference)¹</i>	LEVEL A ²	LEVEL B ²	LEVEL C ²
<i>Initial Exposure Assessment</i>	YES	YES	YES
<i>Initial Monitoring (W3)</i>	As Needed ³	As Needed ³	As Needed ³
<i>Negative Exposure Assessment</i>	Required ⁴	Required ⁴	Not Required ⁵
<i>Periodic Monitoring (W8)</i>	NO ⁶	NO ⁶	YES
<i>Fiber Release Potential</i>	Low/Minimal	Below PEL	Above PEL
<i>Worker Protection</i>	Basic	Moderate	Full O&M
<i>Area Protection</i>	Basic	Moderate	Enclosure
<i>Training (APM5)</i>	O&M/ Awareness ⁷	O&M	O&M+ ⁸
<i>HVAC System Off (W3)</i>	NO ⁹	As Needed	YES
<i>Vacate Area (W4, APM2)</i>	NO	YES	YES
<i>Critical Barriers (W5)</i>	NO	NO ¹⁰	YES
<i>Regulated Work Area (W4)</i>	NO	YES	YES
<i>Respiratory Protection (W6)</i>	NO	YES ¹¹	YES
<i>Protective Clothing (W7, W15)</i>	NO	YES	YES
<i>Preclean (W9)</i>	NO	As Needed ¹²	As Needed ¹²
<i>Use HEPA Vacuum (W9)</i>	YES	YES	YES
<i>Wet Methods (W9)</i>	YES	YES	YES
<i>Work Area Protection (W10)(W20)</i>	NO ¹³	Drop cloth	Mini-Enclosure, Glovebag Negative-Pressure System ¹⁴
<i>Lockdown (W12)</i>	NO	As Needed	As Needed ¹²
<i>Clean Tools and Work Area (W14)</i>	YES	YES	YES
<i>Visual Inspection (W16)</i>	NO	As Needed	As Needed
<i>Air Clearance (W16)</i>	NO ¹⁵	NO ¹⁵	As Needed ¹⁶
<i>Personal Decontamination (W15)</i>	NO ¹⁷	HEPA Vac	Shower
<i>Notification</i>	NO	YES	YES

NOTES:

- The general procedures in parentheses provide additional information on the noted item.
- The exact meaning of these three levels will vary depending upon the fiber release objectives which are specified in the design of the O&M plan for a specific building (see Design of O&M Practices (Section 4) for further explanation). State and local requirements may be different & some may be more stringent than these guidelines.
- Initial monitoring may be required while making a negative exposure assessment (NEA). The NEA can be based on objective data, data from previous jobs, or initial monitoring. For Level C an NEA may not be possible.
- A negative exposure assessment is required because the work practices in this manual for this level are performed without enclosure.
- Level C work is performed inside of an enclosure so that a negative exposure assessment is not required by OSHA. However, airborne fiber levels inside mini-enclosures should be maintained below the OSHA PELs if possible.
- Level A and B in this manual require a negative exposure assessment during design of the work practice. For this reason periodic monitoring is not required. However, an initial exposure assessment and periodic monitoring may be required in the future if there is a change in process, control equipment, personnel, or work practices that may result in new or additional exposures.
- Class IV work (contact but do not disturb ACM) requires awareness training. Class II work on non-friable materials (e.g. roofing, siding, ceiling tiles, and cement asbestos board 'transite') require a minimum of 8 hours of O&M training including training in specific work practices for the material, engineering controls, hands-on training as well as the elements required in paragraph (k)(9)(viii) of the construction standard (see Appendix I "Regulations").
- Training beyond O&M should be provided for the Level C work practices in this manual. This should include specific training in glovebag and mini-enclosure procedures. The mini-enclosure is a potentially contaminated environment. At a minimum, mini-enclosure workers should receive the same worker protection, and personal and environmental decontamination training as abatement workers.
- Turn off HVAC if work will be performed on HVAC system(s).
- Critical barriers may be necessary or be specified for particular cases by the APM.
- This manual presumes that respiratory protection will be provided for all Level B work. However, OSHA allows respiratory protection to be deleted for work on non-friable materials (non-surfacing and non-TSI) if a negative exposure assessment has been made, the material is removed intact, and wet methods are used.
- May be recommended - see work practices. Adequate training is necessary.
- Drop cloth optional for dirty tools, equipment and/or waste.
- Work area protection may be revised if alternate methods are used and historic data are available.
- Air clearance depends on air monitoring program specifications.
- Clearance monitoring should be considered during development of mini-enclosure procedures. After mini-enclosure use has been validated (NEA after tear down) consider discontinuing clearance monitoring.
- Personal decontamination may be specified by APM or O&M program.

Resilient Flooring:

Resilient flooring is treated differently by OSHA, and as such the level definitions for these materials differs from that of other ACM. There are two different types of Level A, and a Level B+ that replaces both Levels B and C.

Level A1: Level A1 is defined in terms of Class II work in the construction standard (29 CFR 1926.1101). It is Class II work with a negative exposure assessment that involves removal or repair of resilient floor covering materials (refer to the introduction to the resilient flooring work practices section, Pages R-2 through R-9, for information on the requirements for a negative exposure assessment with resilient flooring). See Figure 2 for checklist of requirements.

Work practices: required for Level A1 are those set forth in paragraph (g) (8) of the OSHA asbestos construction standard for Class II work involving resilient floor covering materials and in the compliance directive (CPL 2-2.63 Appendix D pages 34-36 November 3, 1995). If more than a small quantity of material is disturbed during work covered by the construction standard, then the activity exceeds the limitation of the work practices in this manual. Refer to the NIBS manual *Model Guide Specifications, Asbestos Abatement and Management in Buildings* for more information.

Level A2: Level A2 is defined in terms of "housekeeping" in the general industry standard (29 CFR 1910.1001) and in the construction standard (29

CFR 1926.1101). It encompasses routine housekeeping operations covered by the general industry standard, where a determination has been made that cleaning buffing or polishing activities using the work practices in this manual (which are based on those contained in the OSHA regulation) are not reasonably expected to result in exposures exceeding the PEL. See Figure 2 for checklist of requirements. Note: When these activities are performed in relation to a construction operation, the construction standard (1926.1101) applies, and a negative exposure assessment is necessary (refer to Appendix I).

Work practices: required for Level A2 are those set forth in the OSHA general industry standard for non-construction-related housekeeping activities. Awareness training must be provided annually, in a manner that is comprehensible to all employees. Paragraph (k) of the general industry standard has specific requirements for stripping of finishes and burnishing or dry buffing asbestos-containing flooring. Note: If these activities are performed as part of a construction project, the construction standard (1926.1101) would apply. Refer to Appendix I for more information.

Level B+: Level B+ is removal of resilient flooring materials that are not intact, or will become non-intact during removal, or where a negative exposure assessment cannot be made. (Note: Material in this condition is described as "RACM," under the EPA/NESHAP

regulations. Refer to Appendix I for more information on NESHAP requirements.) These augmented Level B work practices can be used for work on resilient flooring where flooring materials become friable, if the OSHA PEL is not exceeded and release of ACM, dust and debris is confined to the immediate location of the disturbance. To comply with OSHA, Level B work practices used for this purpose require critical barriers, as well as the respiratory protection, air monitoring and other work practices normally associated with Level B work. If more than a small quantity of material is disturbed during the work, then the activity exceeds the limitation of the work practices in this manual. Refer to the NIBS manual *Model Guide Specifications, Asbestos Abatement and Management in Buildings* for more information.

Work practices: required for Level B+ are the same as those required for Level B in figure 1, with the addition of critical barriers. OSHA requirements for Level B work are set forth in paragraph (g)(8) of the asbestos construction standard for Class II work involving resilient floor covering materials. These work practices include O&M training, respirators, engineering controls and work practices, wet methods, local exhaust ventilation, prompt clean-up of debris, and waste disposal in leak-tight containers. Level B+ adds critical barriers as required by paragraph (g)(7) of the standard. See Figure 2 for checklist of requirements.

Figure 2, which follows, summarizes the engineering controls and practices recommended for each level. The APM should determine the appropriate level, based on the O&M program objectives, the O&M program elements, and level of training needed for each level of work practices used in a facility.

Figure 2: OSHA Requirements for Work Practices for Resilient Floor Covering Materials

ITEM	LEVEL A1 ^{1,2}	LEVEL A2 ¹	LEVEL B+ ³
Work Practices	R1-A & R2-A ^{4, 5}	R5-A, R6-A, R7-A	R1-B, R2-B, R4-B, R8-B
OSHA	1926.1101	1910.1001 ⁶	1926.1101
Initial Exposure Assessment	YES	YES	YES
Initial Monitoring (W8)	Not Required	If Needed ⁷	Required
Negative Exposure Assessment	Required	Not Applicable ⁸	Not Required
Periodic Monitoring (W8)	NO	NO	YES
Fiber Release Potential	Low/Minimal	Low/Minimal	Below PEL
Worker Protection	NO	NO	Moderate
Area Protection	NO	NO	Moderate
Training	8 hr flooring specific ⁹	Awareness	O&M
HVAC System Off (W3) ¹⁰	NO	NO	As Needed
Vacate Area (W4, APM2) ¹⁰	NO	NO	YES
Securing the Work Area (W4) ¹⁰	NO	NO	YES
Regulated Work Area (W4)	YES ¹¹	NO	YES
Respiratory Protection (W6) ¹⁰	NO	NO	YES
Protective Clothing (W7, W15) ¹⁰	NO	NO	YES
Preclean (W9)	NO	NO	As Needed
Use HEPA Vacuum (W9)	YES	As Needed ¹²	YES
Wet Methods (W9)	YES ¹³	As Needed ¹²	YES
Critical Barriers (W5)	NO	NO	YES
Lockdown (W12)	NO	NO	NO
Clean Tools and Work Area (W13)	YES	YES	YES
Visual Inspection (W16)	NO	NO	YES
Air Clearance (W16) ¹⁰	NO	NO	NO
Personal Decontamination (W15) ¹⁰	NO	NO	HEPA Vac
Notification	YES ¹⁴	NO	YES

NOTES

- Applies to Intact Resilient Flooring: "Intact" is defined by OSHA as ACM that has not crumbled, been pulverized or otherwise deteriorated so that it is no longer likely to be bound within its matrix. The incidental breakage of flooring materials, or slicing of sheet vinyl floor covering with a sharp edged instrument, during removal operations conducted in accordance with the Recommended Work Practices does not mean that the materials are not removed in an intact condition. OSHA has stated that resilient floor covering materials are considered non-friable if intact and generally do not emit airborne fibers unless subject to sanding, sawing, or other aggressive operations.
- The EPA NESHAP regulation (40 CFR Part 61, Subpart M) defines asbestos-containing resilient floor products as Category 1 non-friable materials, which are not regulated by the NESHAP unless they become friable or are subjected to sanding, grinding, cutting or abrading. Cutting in this instance includes sawing, but not shearing, slicing or punching.
- Asbestos-containing resilient flooring products that have become friable or are rendered friable during removal are Regulated Asbestos-Containing Materials (RACM) under the EPA NESHAP regulation (40 CFR Part 61, Subpart M) and must be handled and disposed of accordingly. Refer to Appendix I "Regulations" for information on NESHAP requirements.
- Work Practices R1-A and R2-A are governed by the OSHA Construction Standard, 29 CFR 1926.1101.
- Work practices R3-A and R4-A are in figure 1.
- Work Practices R-5A, R-6A and R-7A in this manual are normally governed by OSHA General Industry Standard (29 CFR 1910.1001) when they are part of routine cleaning in public and commercial buildings where construction activity is not taking place, but are governed by the construction standard (29 CFR 1926.1101) if they are performed in relation to construction activities. See Compliance Directive at C-18.
- The employer may forgo initial monitoring where a determination has been made that cleaning buffing or polishing activities using the work practices in this manual (which are based on those contained in the OSHA regulation) are not reasonably expected to result in exposures exceeding the PEL. Note: if these activities are performed as part of a construction project, the construction standard (1926.1101) would apply, and a negative exposure assessment would be necessary (refer to Appendix I).
- The general industry standard does not have a provision for a negative exposure assessment.
- Additional 4 hours of training required for competent person.
- The designer may specify additional quality control measures, although these are not required by regulation. This may be specified by the owner because of a condition of the job, but may result in additional cost being incurred.
- Demarcation not required if access restricted (Vol. 60 Federal Register, page 33974, June, 29, 1995).
- Shoveling, dry sweeping and dry clean-up of asbestos may be used only where vacuuming and/or wet cleaning are not feasible. [29 CFR 1910.1001(k)(5)] Waste and debris and accompanying dust in an area containing accessible ACM and/or PACM or visibly deteriorated ACM, shall not be dusted or swept dry, or vacuumed without using a HEPA filter. [29 CFR 1910.1001(k)(8)]
- Wetting is not required when heat is used to remove intact floor tile.
- Notification - See 29 CFR 1926.1101(c)(2)(i).

4. Design of O&M Work Practices

DESIGN OF THE O&M PROGRAM

The O&M program for a specific facility needs to be designed. Frequently, this design will be developed cooperatively by an asbestos control designer and a facility person who then becomes the Asbestos Program Manager (APM). The designer needs to have specialized knowledge in asbestos control procedures and the application of these procedures to maintenance activities and often is required to be licensed by State or Local regulations. The Asbestos Program Manager has knowledge of the practices and administrative procedures of the facility. The Asbestos Program Manager implements the program once it has been designed. This manual is concerned primarily with the design of O&M work practices for a facility's asbestos O&M program. The nature of these work practices will depend on decisions made by the facility owner in setting up an asbestos O&M policy. The steps the O&M designer and APM need to take to set up an asbestos O&M program include:

- **Definition of Scope:** The designer needs to determine the type, location and condition of ACM that need to be controlled by the O&M program. This may require an inspection of the facility. An existing inspection report can be used for this purpose if it is sufficiently comprehensive and specific. The inspection report needs to be the first O&M program document. It needs to be made available and explained to all who will be involved in implementing the O&M.
- **Policy and Organization:** The designer needs to assist the building owner in making the necessary policy decisions to effectively implement the O&M program. The administrative position in the organization with the appropriate authority for the Asbestos Program Manager (APM) must be identified, and given the responsibility for implementing the program. The APM must have direct line authority over any activity that could affect ACM in the facility. This includes authority over in-house cleaning and maintenance staff, and contracted cleaning, custodial, maintenance, and renovation work.

The building owner, with the advice of the designer, needs to establish the asbestos exposure goals of the O&M program. To be useful in the design of O&M work practices these goals need to be stated in (or translatable into) terms of permissible asbestos levels for the facility, and for the workers engaged in O&M work. Frequently the building owner will state the goals in general terms such as, "lowest possible," "lowest feasible," or "as required by applicable regulation." In this instance the designer will need to translate this into terms of permitted airborne concentrations of asbestos.
- **Program Administration:** The designer needs to work with the APM in setting up a workable set of administrative procedures to insure

that O&M work practices will be routinely and reliably applied when needed. The designer will provide information about asbestos control and regulatory compliance requirements, and the APM will know how existing administrative systems work. Usually, the best procedures result from making minor additions to existing administrative procedures. The APM will use these administrative procedures to implement the O&M program.

- **Documentation:** The designer needs to work with the APM in setting up a system that the APM can use to document the operations of the O&M program. This manual contains example forms in the appendices that can be used as a starting point for a documentation system. This documentation must include the recordkeeping required by OSHA and the EPA. It should also include documentation sufficient to demonstrate that the effective application of controls over disturbance of ACM.
- **Controlled Area:** The designer will assist the APM in designating Controlled Areas. A signage system to notify a worker entering a controlled area about the type and location of ACM present in the area, and work practices required by the O&M program needs to be devised, and signs posted. This system needs to meet requirements of OSHA (29 CFR 1926.1101(k)(6)).
- **Controlled Systems:** The designer

will assist the APM in designating controlled systems. A labeling system to notify a worker that a system contains asbestos needs to be devised, and labels posted. This labeling may also include information about the controls required by the O&M program for each system. This system needs to meet requirements of OSHA (29 CFR 1926.1101(k)(8)(vii)).

- **Work Practices:** The O&M designer can use the work practices in this manual as the starting point for developing work practices specific to the facility. These work practices then need to be modified as required by conditions within the facility. The work practices need to be tested or validated to determine if the airborne asbestos level goals have been met. The work practices need to be adjusted until these goals are efficiently and reliably met. The APM supervises the application of these work practices to maintenance activities that involve ACM.
- **Training:** The O&M designer assists the APM in determining the training requirements for each participant in the O&M program, and setting up the administrative procedures necessary to insure that training is provided, records of training kept. More information on training requirements can be found in Appendix I "Regulations."
- **Communications:** The O&M designer assists the APM in developing standard notification

forms and memos, and setting up the administrative procedures necessary to insure that notifications are made as required by the O&M program.

- **In-house Personnel:** The O&M designer helps the APM set up the administrative controls necessary to insure that only persons with equipment and training appropriate to the work contact or disturb ACM.
- **Contractors:** The O&M designer helps the APM develop the necessary notification forms for contractors. A

procedure must be developed to insure that receipt of this notification is acknowledged by contractors in the form of a submission to the APM prior to the start of any work. The O&M designer develops the contract document for a unit price contract if this is going to be used as part of the O&M program.

- **Audit and Review:** The O&M program designer may review the O&M program on a periodic basis, and assist the APM to make any modifications that are necessary.

DESIGN OF O&M WORK PRACTICES

Before an O&M work practice can be designed, it is necessary for the facility owner/manager to determine the goals of the O&M program in terms of permitted airborne asbestos levels for the facility and workers. A work practice is selected from the examples given in this manual. The work practice is modified as necessary to meet conditions in the facility. The work practice needs to be tested and developed until it meets the asbestos level goals for the facility.

Environmental Goals: The facility owner/manager needs to establish a limit for airborne asbestos levels that result from O&M work. At a minimum this level must meet OSHA requirements and the OSHA PEL's must not be exceeded for building occupants. Some building owners/employers might choose to simply achieve regulatory compliance. Others might establish O&M programs with more precautionary criteria for

protection of workers and the building environment. Regulations do not set precise standards for the protection of building environments.

Examples of building environment criteria commonly used by owners are:

- The OSHA permissible exposure limit (PEL) - 0.1 f/cc by PCM as an 8-hour time weighted average (TWA), and 1.0 f/cc as a 30-minute excursion limit. This standard must be met as the maximum exposure level allowed by the regulation.
- 0.01 fibers per cubic centimeter of air by PCM (EPA Purple Book)
- The AHERA standard, or state standards, requiring a comparison of inside work area samples to outside work area samples
- 70 structures per square millimeter for air samples of at least 1200 liters (AHERA level where comparison to outside is not required)

- Outside ambient air levels
- Inside ambient air levels under conditions where there is no active disturbance of ACM
- Indoor air standards for asbestos as regulated by state or local agencies.

Worker Exposure Goals: The facility owner/manager must establish an upper limit on the exposures to workers engaged in O&M work. Building owners and/or employers must comply with OSHA and other applicable regulations which relate to maintenance procedures and worker protection. This means that as a minimum requirement a worker's exposure must not exceed the OSHA PELs during execution of O&M work practices. Some building owners/employers might choose to simply achieve regulatory compliance. Others might establish O&M programs with more precautionary criteria for protection of workers.

Examples of worker exposure limit criteria commonly used by owners are:

- The OSHA permissible exposure limit (PEL) - 0.1 f/cc by PCM as an 8-hour time weighted average (TWA), and 1.0 f/cc as a 30-minute excursion limit. This standard must be met as the maximum exposure level allowed by the regulation
- 0.01 fibers per cubic centimeter of air by PCM as an 8-hour time weighted average
- Inside ambient air levels under conditions where there is no active disturbance of ACM
- Standards for asbestos exposure as regulated by state or local agencies.
- Requirement that maintenance workers always be equipped with

respirators when working on ACM, regardless of measured exposure levels.

Selecting Work Practices The O&M designer should select the work practices from this manual that are closest to conditions in the facility where the work will be performed. If situations exist that are not covered by this manual, the O&M designer should develop work practices based on the guidelines in this manual and other sources. It might be desirable to obtain assistance from sources, such as qualified consultants, regulatory authorities, legal counsel, risk managers or insurance companies when selecting appropriate work practices.

A number of determinations must be made in order to select the appropriate work practice for a given situation. These include:

- The level of worker and environmental protection desired based on the O&M program objectives.
- Whether O&M work will be performed by staff personnel or an outside contractor. The O&M program could specify that some activities or work practice levels be done with in-house personnel, while other activities or levels are done by contractors. If O&M work is to be performed by contractors, the APM's responsibilities and activities might be changed to include contract administration, submittal reviews, and verification that O&M work and monitoring is being performed as required. Modifications to the Work Practices, APM Checklist, Worker Checklists and General Procedures might be needed.

- Regulatory compliance issues for the specific facility and personnel who will perform the work. These include OSHA and EPA requirements for worker protection, work practices, exposure monitoring, notifications and additional state or local requirements.
- Whether exposure monitoring data and work evaluation forms (see Appendix C) from past work indicate that a given work practice or work practice level accomplishes the O&M objectives.
- In a facility where the combined additive amount of regulated asbestos containing material (RACM) to be removed or stripped during a calendar year exceeds the EPA NESHAP requirements, environmental agencies must be notified and area and environmental controls are required. (RACM is specifically defined by the NESHAP regulations and can be found in Appendix I, Regulations, or Appendix F, Glossary, of this manual.) EPA's AHERA regulations apply to any asbestos work conducted in schools. State and local regulations may have requirements that differ from federal regulations and some may be more stringent. Appendix I includes more information on OSHA and EPA regulations.

Modify the Work Practice: The work practice selected should be modified as required by specific facility requirements. The materials in a given facility may react differently to being worked on and may require more or less asbestos control procedures to meet the airborne asbestos goals. Damaged or very fragile materials may require great care and use of extensive asbestos control

procedures. Intact, less fragile materials may require fewer controls. Characteristics of the ACM may require that different controls be applied. For example, local exhaust ventilation using a HEPA vacuum may be emphasized over wetting to prevent water staining of ACM architectural finishes. The following are factors which should be considered when modifying a work practice for use in a specific facility:

- Fiber release potential of material or O&M activity
- Condition and friability of ACM
- Exposure and air monitoring data
- Training, skill and experience of workers
- Quantity of ACM to be disturbed
- Type and percentage of asbestos
- Location and use of ACM
- Exposure potential for occupants and other personnel
- State and local regulations
- O&M and other management policies
- HVAC and ventilation system configurations
- Presence of on-site supervision
- Asbestos-containing dust and debris

Users of this manual might have operations and maintenance program objectives which are more protective than the minimum regulatory requirements. Accordingly, it might be appropriate, in the development of work practices, to consider more than just the OSHA and EPA regulatory requirements. The conditions of the building and the O&M program objectives will dictate the work practice level necessary.

The work practices in this manual are

generally limited to activities that are within the OSHA Class III limitation that ACM to be disturbed fit in one 60 inch glovebag or disposal bag. This is a fairly large amount of material, and definitive quantities of ACM below this level have not been specified in the work practice level examples. This is to provide greater flexibility and to emphasize that other factors might influence level selection by

the APM. For Class II work, such as flooring or roofing operations, the work practices in the manual are limited to a small quantity of material. The APM's determination of the appropriate level will often be based, at least in part, upon the quantity of ACM to be disturbed. The work practices are generally designed for disturbing small amounts of asbestos as required to perform O&M tasks.

TESTING AND VALIDATING THE WORK PRACTICE

The work practice needs to be tested to see if it results in airborne asbestos levels that meet the exposure goals of the O&M program. An initial exposure assessment should be made for the work practice. This assessment can be based on objective data, historic data from another job, or on initial exposure monitoring collected while the work practice is used. Area monitoring may also be necessary particularly if the environmental exposure limit specified by the owner or designer is lower than the OSHA PEL. If the work is of very short duration, it may be necessary to repeat it a sufficient number of times to collect air samples that are large enough to provide an detection limit that is low enough to compare against the goals for airborne asbestos. Personal samples on the workers will indicate if the exposure to the workers is within the goal. Area samples near the work will indicate if the goal for the building environment has been met.

Exposure Monitoring: The effectiveness of work practices subject to the OSHA construction standard needs to be validated by air monitoring where a negative exposure assessment cannot be made based upon existing data. Such

exposure monitoring is required by OSHA and will be needed to demonstrate that each work practice level meets the goals for airborne asbestos exposure levels. Area monitoring will also be necessary, particularly if an airborne asbestos goal less than the OSHA PEL is established. To fit within the level definitions, the following must hold true:

- **Level A** work practices should not result in an elevation of airborne asbestos levels. Respiratory protection should not be necessary during Level A activities. If there is a question about the need for respiratory protection the work becomes Level B. A negative exposure assessment is required.
- **Level B** work practices may result in localized elevations of airborne asbestos levels, but these levels do not exceed the OSHA PELs, and only affect the worker, but not the building environment. Respiratory protection is required as a worker protection measure. A negative exposure assessment is required, so that enclosure is not required by the OSHA regulation. If a negative

exposure assessment is not possible the work must be enclosed and is Level C.

- **Level C** work practices may result in elevations of airborne asbestos levels above the PELs, or involve drilling, cutting, abrading, sanding, chipping, breaking or sawing TSI or surfacing ACM. Respiratory protection is required. A negative exposure assessment is not possible so that the work requires additional worker protection, as well as isolation of the work area from the rest of the facility.

The only way that a work practice can be validated is to perform the procedure and monitor airborne levels during the work. Personal monitoring is required to determine worker protection requirements, and if work area isolation is needed. In addition, area monitoring may be necessary to demonstrate that the remaining building environment is not exposed to elevated asbestos levels. If no disturbance of ACM will occur (such as with many Level A work practices), monitoring requirements may be minimal. Meaningful exposure monitoring requires sufficiently long sample durations. Readings are not instantaneous. O&M procedures are small in scale and short in duration, requiring that many procedures be repeated a number of times to enable the collection of a sample with sufficient sensitivity.

OSHA requires that air monitoring be performed to determine what level of worker protection is necessary in construction related activities. OSHA specifies requirements for the determination of airborne fiber levels and worker exposures in the Code of Federal Regulations (29 CFR 1926.1101 (f)).

OSHA requires employers to determine initially the level of airborne fibers to which an employee will be exposed through an "initial exposure assessment." A "negative exposure assessment" can be made by use of objective data, historical data from past jobs, or by initial exposure monitoring. (OSHA treats intact removal of resilient flooring differently, refer to the introduction to Section VII "O&M Work Practices, Resilient Flooring," for more information.) OSHA then requires periodic monitoring of construction activities including O&M unless a negative exposure assessment is made, supplied air respirators are used, or statistically reliable measurements indicate that the PEL is not going to be exceeded. Monitoring must be resumed (unless supplied air respirators are used) if there is a change in workers, the activity, or equipment use occurs which might result in exposures above the permissible exposure limits (PELs). These air monitoring requirements provide building owners and managers with the information necessary to determine what level of protection is required by the federal government. State and local laws may be more stringent. Refer to Appendix I "Regulations," for more information on OSHA exposure monitoring requirements.

Personal monitoring should consist of samples to obtain an 8 hour time-weighted average (TWA), and excursion limit (EL) monitoring samples. All analysis for OSHA compliance should be by phase contrast microscopy (PCM). Transmission electron microscopy (TEM) analysis will distinguish asbestos fibers from other fibers and might also be used if desired, although PCM data is required by OSHA. TEM data cannot substitute for OSHA required PCM data unless

approved by the local OSHA office.

The Air Monitoring Program developed for a specific facility needs to address how exposure monitoring will be conducted to provide data for use in the design and validation of work practices. The program should define exposure limits for both workers and the building environment.

Air monitoring and analysis by PCM required by OSHA for exposure monitoring does not distinguish between asbestos and non-asbestos fibers and cannot measure the short or thin fibers that might be detected using Transmission Electron Microscopy (TEM). Air monitoring data for OSHA exposure might not be an accurate predictor of TEM results. Some TEM data indicate that workers might be exposed to short or thin fibers when performing O&M activities. O&M activities might create small fibers when work such as cutting or drilling of ACM is performed. TEM analysis of clearance samples is required by the federal government under AHERA for applicable school projects involving ACM which is or becomes friable.

Initial Exposure Assessment:

The monitoring required for an initial exposure assessment is discussed in paragraph (f)(2) of the OSHA construction standard 29 CFR 1926.1101: "(I) Each employer who has a workplace or work operation covered by this standard shall insure that a "competent person" conducts an exposure assessment immediately before or at the initiation of the operation to ascertain expected exposures during that operation or workplace."

Negative Exposure Assessment (NEA): Level A and B work practices are

performed in the open rather than inside an enclosure. To meet OSHA requirements this is possible only if a negative exposure assessment (NEA) is made. During design and development of a work practice the NEA must be made. If an NEA is not possible, then the work practice is a Level C and must be performed inside of an enclosure.

The OSHA construction standard sets forth the criteria that must be met to demonstrate that worker exposures will be below the PEL in 29 CFR 1926.1101(f)(2)(iii). The following briefly outlines the highlights of that paragraph. The standard should be referred to when attempting to make a negative exposure assessment. (OSHA treats intact removal of Resilient flooring differently. Refer to the introduction to Section VII, "O&M Work Practices, Resilient Flooring," for information on an NEA for resilient flooring.)

A negative exposure assessment can be made based on exposure data that conforms to any one of three criteria:

- **Objective data:** The data must demonstrate that a work practice applied to a particular product or material cannot "release airborne fibers in concentrations exceeding the TWA and excursion limit under those conditions having the greatest potential for releasing asbestos." In Compliance Directive CPL 2-2.63 OSHA states that, "The employer may use data derived from other employers' jobs. The data should reflect worst case conditions in a variety of occupational settings."
- **Historical Data:** Data from exposure monitoring performed by the employer during prior asbestos jobs in

the last 12 months (historic data) can be used as the basis for an NEA. This data must be from, "work operations conducted under workplace conditions 'closely resembling' the processes, type of material, control methods, work practices, and environmental conditions used and prevailing in the employer's current operations, the operations were conducted by employees whose training and experience are no more extensive than that of employees performing the current job, and these data show that under the conditions prevailing and which will prevail in the current workplace there is a high degree of certainty that employee exposures will not exceed the TWA or excursion limit."

- **Initial exposure monitoring:** The results of initial exposure monitoring from the current job can be used as the basis for an NEA. The data used for this purpose must be, "from breathing zone samples that are representative of the 8-hour TWA and 30-minute short-term exposures of each employee covering operations which are most likely during the performance of the entire asbestos job to result in exposures over the PELs." The data must show that exposures are expected to be below the PEL and EL. This initial monitoring usually occurs during the testing and development phase of an O&M work practice.

OSHA governs the employer of the workers performing the O&M work. This means that for an O&M program where the facility maintenance staff are doing work on ACM, the facility owner or manager that employs them must perform

the negative exposure assessment for Level A and B work practices.

If O&M work that disturbs ACM (Level B or C work) is going to be performed by a contractor rather than by facility personnel, then the owner will want to know that the contractor is complying with OSHA. On one hand, it is important that the Contractor's responsibility for worker protection not get confused or diluted by actions by the Owner or Designer. On the other, the Owner needs to be reassured that the Contractor is properly protecting workers, and in particular that a negative exposure assessment has been properly made. The NIBS manual *Model Guide Specifications for Asbestos Abatement and Management in Buildings* contains information on this issue. The NIBS Guide Specifications are structured so that a negative exposure assessment is a contract requirement established by the Owner for purposes of insuring that the building is not contaminated by the O&M work. The Contractor is required to make a submission demonstrating that the exposure goals of the specifications can be met. This is accomplished by submitting data from prior asbestos projects. The submission on personal samples must meet the requirements of an OSHA negative exposure assessment.

Dust and Debris: Dust and debris by their nature are easy to disturb, and the dust can become airborne. If the dust and debris contain asbestos, then this disturbance could result in an increased airborne asbestos concentration. OSHA requires that "Waste and debris and accompanying dust in an area containing accessible thermal system insulation or surfacing ACM/PACM or visibly deteriorated ACM: shall not be dusted or

swept dry, or vacuumed without using a HEPA filter." OSHA, in its November 3, 1995 compliance directive, instructs that, "Employers who know, or should reasonably know that "unaccompanied" dust is asbestos-containing material (ACM) must also comply with these procedures, too. The fact that the standards do not state explicitly when dust must be considered as asbestos-containing does not mean such situations do not exist. For example, where visibly deteriorated ACM is in close proximity to a dust accumulation, and there is no similar dust accumulation where ACM is not so proximate or damaged, a reasonable employer must treat the dust as ACM or have the situation evaluated by a competent person." This instruction is also a strong inference that, absent any reasonably discernable source of asbestos fibers, dust may just be dust, and investigation, sampling or analysis would not be necessary. If, however, there is any discernable connection to nearby ACM, then it must be investigated or presumed to contain asbestos. Asbestos-containing dust and debris should be a controlled system under the O&M program. If the O&M designer determines that there is a potential for increased asbestos exposure due to disturbance of dust and/or debris, work practices should be designed for working on these materials. These work practices can then be tested using the procedures in this section, and adjusted as necessary to meet the exposure goals of the O&M program.

The American Society of Testing and Materials (ASTM) committee D-22.07, Sampling and Analysis of Atmospheres for Asbestos, has recently published two standard methods for analysis of dust by

TEM. One of these quantifies the number of asbestos structures per unit area (D5755-95 Standard Test Method for Microvacuum Sampling and Indirect Analysis of Dust by Transmission Electron Microscopy for Asbestos Number Concentration), the other determines the mass of asbestos per unit area or the percentage of asbestos in the dust (ASTM method D5756-95 Standard Test Method for Microvacuum Sampling and Indirect Analysis of Dust by Transmission Electron Microscopy for Asbestos Mass Concentration). The committee is at work on a "Standard Guide for Evaluation of Asbestos on Surfaces" that will give guidance on the interpretation of results from the ASTM dust sampling methods. Until the guide document is complete, each investigator must make his or her own determination about the applicability of data generated.

If the O&M designer is concerned that there could be exposures from asbestos in dust and/or debris, then this condition should be evaluated using the procedures of this section. An initial exposure assessment should be made, which may include exposure monitoring conducted during activities that disturb the dust and/or debris, and if possible a negative exposure assessment should be made. If airborne asbestos levels generated during work (such as dry sweeping and dusting exceed the exposure goals for the O&M program, then the work practices for these activities will have to be adjusted. If airborne asbestos levels above the exposure goals are generated by activities, then some remedial work (such as use of the cleaning procedures in this manual) is necessary.

WORKER PROTECTION

The negative exposure assessment is necessary for compliance with OSHA for Level A and B work practices. (The exception to this requirement is housekeeping activities under the OSHA General Industries standard, which does not provide for a negative exposure assessment.) OSHA requires respiratory protection for workers involved with surfacing and TSI ACM under all circumstances, and for other materials under specified circumstances. However, the building owner can decide to make worker protection and respiratory protection specifications more stringent than OSHA requirements. Examples of

some requirements used in O&M programs that exceed OSHA requirements include:

- Using a PEL of 0.01 f/cc as a TWA.
- Specifying that respirators be worn at all times that an ACM is disturbed.
- Specifying abatement worker training, particularly for Level C work.
- Specifying a wet decontamination procedure for O&M workers at the end of their shift.
- TEM analysis in addition to PCM analysis of some air samples.

ADJUSTING THE WORK PRACTICE

Sometimes a work practice may be unable to achieve the levels required by the airborne asbestos goal, or it may be unnecessarily stringent. The intensity at which asbestos control techniques (careful handling, wetting, local area exhaust with HEPA vacuum, area exhaust) are applied should be adjusted until the airborne asbestos goals are met. Care should be used to be sure that the finalized work practice is simple to apply, as fail-safe as possible and that it will meet the goals under a variety of conditions and a range of care on the part of workers. The work may be performed by different workers under a variety of temperature and

humidity conditions with varying amounts of time pressure. In time some workers may become jaded and less careful, or more practiced and more proficient. The work practice needs to reliably meet the airborne asbestos goals under a variety of real world conditions, and needs to be subjected to consistent and effective oversight and management. Unless a negative exposure assessment has been made, periodic exposure monitoring will be necessary until a statistically reliable measurement demonstrating consistent success of the work procedure is developed.

NUMBER OF WORKERS

Each work practice summary includes a recommendation on how many workers are needed to perform the work. A number of factors should be considered when determining how many workers are to be assigned to perform an O&M activity, such as:

- Regulatory requirements
- The amount of work to be done
- Accessibility to the work area (height, enclosure)
- Worker skill, training and experience
- Weight, size or length of objects involved in the work
- Worker safety or degree of risk
- Work efficiency and cost effectiveness

One worker is recommended where the work practice can be accomplished safely and effectively with one worker. Two or more workers are recommended for work practices involving enclosures, glovebags or where special conditions or other factors complicate the work. State or local regulations may dictate the number of workers needed. General Procedure APM5 includes additional information on assigning workers.

EXAMPLE

The following is an example of the steps needed to design and test a work practice for the XYZ Office Building in Anytown USA. This example is intended to help clarify the steps needed to develop an O&M work practice for a facility.

Policy and Organization: Upon the advise of the O&M designer, the building owner established 0.01 f/cc by PCM as the permissible exposure limit for the O&M program for both workers and the building environment. In addition, regardless of airborne exposure levels, workers are required to wear respirators and protective clothing for any activity that could disturb asbestos. Air in the building will be sampled and analyzed by TEM on a periodic basis. These are selected as being a easily achievable goals that exceed regulatory requirements.

Selecting a work practice: The first work practice that is needed is one to use when gaining access through metal pan ceilings where there is debris on top of the ceiling from asbestos-containing fireproofing on structural steel in the plenum space above the ceiling. There is known to be asbestos debris on top of the tiles. The designer selects work practice S-1 "Moving one non-asbestos-containing ceiling panel below a plenum space that has exposed surfacing ACM," as being the closest to the situation that exists in the building.

Modify the Work practice: Work practice S-1 is for a lift-out type of ceiling. Ceilings in the facility are metal pans that snap in and out of a grid (with some difficulty). During the 30 years since the building was constructed the ceiling has been opened in all locations

where there is maintainable equipment above the ceiling. The ceiling tiles are easily damaged and disfigured when removed. The facility has a specific procedure using special tools for removing and replacing the metal pans so that they are not damaged. The HEPA vacuum/ careful work practices of S-1 are incorporated into the metal pan removal procedure. To make the O&M simpler, the work practice is to be a Level B work practice.

Testing the Work Practice: The O&M designer has data from previous O&M programs that indicate that the airborne asbestos goals of the O&M program can be met using Level B work procedures. The O&M designer uses this data as the basis of an Initial Exposure Assessment that allows the work to proceed using Level B work practices. The O&M designer works cooperatively with the workers who need to be trained in the asbestos control procedures to use when removing ceiling pans. The workers know how to remove ceiling pans in the particular building, the O&M designer knows how control asbestos. Working together they further develop the procedure so that it accommodates field conditions. During the work, personal samples are collected in the breathing zone of the workers performing the ceiling work. High volume samplers are used to collect area samples at each of the four sides of the drop sheet. The work of removing and replacing ceiling tiles and performing necessary maintenance above the ceiling is continued for the day using Level B work practices. At the end of the day's work, 16 area and 4 personal samples have been collected and analyzed. The personal samples are all below the

OSHA PEL (0.1f/cc), but above 0.05f/cc. The facilities worker exposure limit of 0.01 f/cc can be met with the use of half-face negative pressure respirators. All samples are below the OSHA PEL so that a negative exposure seems likely. The designer decides that more personal samples are necessary before there is sufficient statistical certainty about the results to make a negative exposure assessment. The area samples are all below the detection limit of the analytical method. The O&M designer concludes from this that the exposure limit for the building environment of 0.01 f/cc is being met.

Adjusting the Work practice: The O&M designer and workers decide to try an additional misting step to further reduce worker exposures. This succeeds in reducing exposures to just above 0.01 f/cc in personal samples for workers using the procedure.

Negative Exposure Assessment:

After two more days of personal sampling the O&M designer is satisfied and makes a negative exposure assessment based on the three days of exposure monitoring. All monitoring is discontinued. The work practice is made a part of the asbestos O&M program for the building. Note that in this example the negative exposure assessment is necessary to allow the work practice to be used without enclosures, but is not used to determine worker respiratory protection requirements. The facility's limits for worker exposure is met by requiring the use of a negative pressure half face respirator.

5. Use of O&M Work Practices

Lists of Work Practices and Work Practice Summaries Lists of the work practices in this manual are provided in the Table of Contents and at the beginning of each section of work practices. The first page of each work practice is a summary of the work practice and lists examples of typical situations, associated general procedures, related work practices and certain basic information about the practices. A recommended minimum number of workers is listed for each work practice. A further discussion of the number of workers for O&M activities is included later in this section.

Using Work Practices This section describes one method of using the work practices that have been developed and validated in the previous section. The APM will select the work practices to be used. A decision tree illustrating this selection process is shown in Figure 3. Guidance for selecting the appropriate work practice level is shown in Figures 1 and 2. The process of using work practices developed from this O&M Work Practices Manual, or alternatives based on this manual, for a given situation can be summarized as follows:

1. A Job Request Form (Appendix A) should be completed for work that could disturb ACM. *(Note to APMS: If the required work has been performed in the past, it might not be necessary to complete an APM checklist for each O&M activity. Past checklists can be reused for the selection of work practices.)*
2. The Asbestos Program Manager should complete an APM checklist (Figure 3) and evaluate the work to be performed based upon the information on a completed Job Request Form, available survey and assessment data, and data on past O&M activities (if available). When reviewing data and completing the APM checklist, the following should be determined:
 - Whether the job requested is actually an asbestos O&M activity.
 - The category(ies) of ACM that might be encountered during the work.
 - The appropriate work practice(s) to address the situation. The work practice summaries include a section of "related work practices" that are intended to aid the APM in the selection of the proper work practice.
 - The appropriate level of work practice(s) to be used.
 - Personal protective equipment, if any, for the work.
3. All of the above information should be recorded on a Maintenance Work Authorization Form (see Appendix B). The completed APM checklist should be signed, dated and filed.
4. Copies of information as listed on the APM checklist should be provided to the workers who will perform the work, along with the appropriate work practice checklist. If repetitive O&M

activities using the same work practices will be performed in sequence over a short period of time, a single Maintenance Work Authorization Form may be completed to cover these situations for a single building. Note, however, that the NESHAP requirements apply to a facility if the combined additive amount of Regulated Asbestos Containing Material (RACM) that will be removed or stripped in repetitive activities exceeds the quantities specified in NESHAP (260 linear, 160 square, or 35 cubic feet of ACM). Repetitive tasks might increase exposure levels such that more stringent OSHA worker protection and engineering control requirements are triggered. Caution should be used to insure that each of the repeated O&M activities is a discrete O&M activity. O&M work procedures are based on disturbing a small amount of material over a short period of time. Care must be taken to avoid violating the intent by allowing contiguous activities that add up to a larger scale procedure and a potential accumulation of contamination. If a number of O&M activities need to occur at one time in one location, it might be preferable to treat the work as a larger scale, non-O&M activity. The APM can set limits appropriate for a facility and O&M program that are based on quantities of ACM to be potentially disturbed in single and multiple O&M activities. Exposure monitoring procedures and methods for repetitive activities might need to be more stringent than for single activities. The forms used in Appendices A, B and C of this O&M

Work Practices Manual are reproduced from the EPA Green Book for use or guidance. Users of this manual can use these as a basis for developing forms for their O&M program and work permit process. It is recommended that O&M forms include the basic categories of information that are used on the Green Book forms.

5. An initial exposure assessment will have been made during design of the work practices. However, in instances where ACM could be disturbed, OSHA requires that personal air monitoring (periodic monitoring) be performed for work practices unless employee exposures, as indicated by statistically reliable measurement, are below the OSHA permissible exposure limits (see OSHA regulations for details). OSHA requires that employees be informed in writing of the results of exposure monitoring either individually or by posting the data in a central location that is accessible to affected employees. Data generated during this periodic monitoring can be used by the APM during future development of work practices. If O&M activity data are to be used to qualify for OSHA historical data exemptions or for maintaining OSHA exposure records, it is necessary that the information be kept in strict accordance with the requirements of the OSHA construction standards (29 CFR 1926.1101(n) and 1926.33). The work practice user is responsible for proving compliance with all applicable federal, state and local regulations. Based upon the data obtained, the APM might decide to

Figure 3: Work Practice Selection

**Asbestos Program Manager Tasks:
Work Practice Selection and Use**

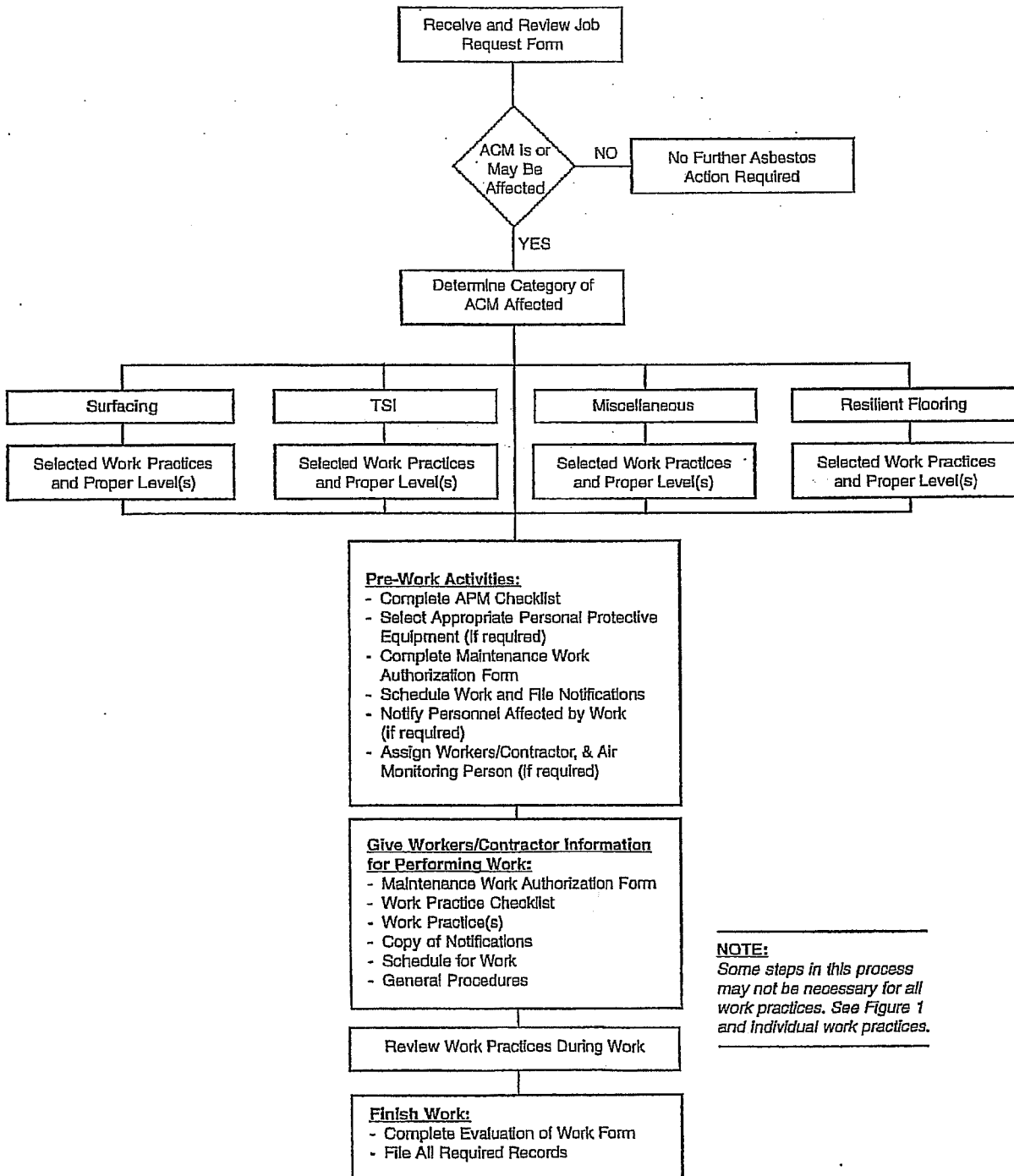

NOTE:
Some steps in this process may not be necessary for all work practices. See Figure 1 and individual work practices.

use a higher or lower level of work practice for a specific task. Substantially more data are required to justify the use of lower level work practices. Any data indicating higher exposures than anticipated warrant consideration of moving to higher level work practices. Work practice levels may be modified as noted in Figure 1 based upon historical air monitoring data (additional information on historical data is provided in General Procedure APM6). Note also that state or local regulations may require more stringent work practices, higher levels of precaution or additional monitoring.

Work Practice Checklists The work practice selection process outlined above and additional information related to the selection and use of the work practices are compiled on the "Asbestos Program Manager Checklist" shown in Figure 3.

Checklists to be used by workers for each level of work practice are shown on "Worker Checklists" in Figures 4, 5 & 6. A checklist is to be provided to the worker with each work practice in order to give the worker complete information required to perform the work.

II. Asbestos Program Manager General Procedures

Q
M

Figure 4: APM Checklist

Asbestos Program Manager (APM) Checklist for Operations and Maintenance Work Practice Use

- Receive and review Job Request Form - *See Appendix A.*
Work to be performed: _____

- Review or request survey data to determine whether ACM is affected.
- Complete Maintenance Work Authorization Form, including: - *See Appendix B.*
 - Review historical air monitoring data for work practices to be used.
 - Work Practice(s) selected for all ACM to be encountered -
See Section I - Figures 1, 2.
 - Select personal protective equipment and decontamination requirements to be used, if needed - *See General Procedure APM1.*
 - Select appropriate materials and review potential hazards (confined spaces, scaffold use, etc.) - *See General Procedures APM8 & APM9.*
- Schedule work when area is not in use or plan developed to isolate area (if necessary) -
See General Procedure APM2.
- Federal, state and local notifications filed (if applicable) -
See General Procedure APM3.
- Notify personnel affected by work - *See General Procedure APM4.*
- Assign workers (or contractor) with appropriate level of training. Verify currency of training, fit tests, and medical surveillance - *See General Procedure APM5*
- Assign trained air monitoring person and determine air monitoring to be performed (if needed). Record air monitoring requirements on Maintenance Work Authorization Form -
See General Procedure APM6.
- Provide copies to workers/contractor of:
 - Maintenance Work Authorization Form
 - Work practice checklist for proper work level.
 - Work practice(s): _____
 - General Procedure(s)
 - Notifications
 - Schedule of work
- As practical, review work practices during work for compliance with requirements and worker general procedures.
- Complete Evaluation of Work Affecting ACM form - *See Appendix C.*
- File all required records in proper files - *See General Procedure APM7.*

Signature: _____ Date: _____

Section II Asbestos Program Manager General Procedures

All references in this manual to Asbestos Program Manager (APM) refer to a person designated to perform the Asbestos Program Manager's duties. This could be the building manager, owner, or another person reporting to the APM.

The Asbestos Program Manager or a designee should review work practices with the workers who will perform the work. Workers should be notified to consult with the APM or the APM's designee if they have any questions during the work, if any problems occur, or if it appears to the workers that additional precautions might be necessary to safely perform the work.

This section includes detailed procedures for steps that are common to many of the work practices. These general procedures are referenced in the work practices and in

the APM checklist. The general procedures should be covered in O&M training related to the use of this manual.

Not all of the general procedures are used in every work practice. The work practices and checklists refer the user to applicable general procedures for detailed information on how to perform a certain portion of the work. Once a user is familiar with the general procedure requirements, it might not be necessary to review the general procedures each time an O&M activity is performed. However, the general procedures should be reviewed periodically by the APM to verify that the proper procedures are being followed.

Users of the O&M Work Practices Manual should also review the General Safety Considerations information in Appendix H.

APM Checklist	44
APM 1 Selection of Personal Protective Equipment & Decontamination Procedures	46
APM 2 Work Scheduling	47
APM 3 Federal, State and Local Notification	47
APM 4 Notification of Personnel	48
APM 5 Assigning Workers	48
APM 6 Developing the Air Monitoring Program and Assigning Air Monitoring Personnel	49
APM 7 Record keeping	51
APM 8 Confined Spaces	51
APM 9 Selection of Materials	52
APM 10 Emergency Work and Dry Removal	54

Note: Not all of the general procedures are used in every work practice.

Selection of Personal Protective Equipment & Decontamination Procedures

Selecting personal protective equipment (PPE) for O&M work includes the selection of respirators, protective clothing, gloves, boots, hardhats, and/or other equipment that might be necessary for a specific task. The information in Appendix H discusses general safety considerations that may affect equipment selection.

Respirators A respiratory protection program is required for any work that requires the use of respirators. This must be a written program, and must include worker training and medical surveillance. The program must clearly inform the worker about the type and level of respiratory protection required for each activity. The worker must be fit tested for a respirator and a respirator must be provided. The worker must be trained in the proper use, care and maintenance of respirators. The medical monitoring must include a physician's opinion that the person is able to wear a respirator.

Respirators used for O&M activities must be selected based on the requirements of regulations and a Respiratory Protection Program developed in accordance with OSHA standards 29 CFR 1926.1101(h), 29 CFR 1910.134 or the EPA "Worker Protection Rule" (40 CFR 763.120,121), as applicable, for the O&M workers. Appendix E of the Green Book includes EPA's recommendations on the types of respirators to be used for custodial and maintenance tasks. Liability concerns, historical data and management policies might also influence whether respirators are used, and if so, the type of respirators for O&M activities. NIOSH recommends minimizing occupational exposure to cancer producing substances, such as asbestos to the lowest feasible level. In practice, a maximum exposure level for workers of 0.01 fibers per cubic

centimeter of air inside the respirator is commonly used when respirators are selected using protection factors.

OSHA has stated that significant risk remains at the OSHA permissible exposure limit. As such, OSHA requires respirator use in some situations (such as when working on Surfacing or TSI ACM) regardless of exposure levels. The EPA's White Book and the Introduction and Section 01562 of the NIBS Asbestos Abatement Guide Specification contain information regarding respirator selection that might be helpful to the APM. Review of this additional information is strongly encouraged.

In certain situations, full face respirators might be desirable to provide additional eye and face protection for workers. Powered Air Purifying Respirators (PAPR's) are preferred by many workers instead of negative pressure respirators. OSHA regulations 29 CFR 1910.1001 and 29 CFR 1926.1101 require that an employer provide a PAPR in lieu of a negative pressure respirator if an employee chooses to use this type of respirator.

Depending upon the type of work and work practices to be used, combination respirator filter cartridges or a different type of respirator might be necessary to protect workers from other contaminants or hazardous substances. Respiratory protection for asbestos work requires the use of high efficiency particulate air (HEPA) filter cartridges.

Protective Clothing & Decontamination Procedures

Protective clothing for O&M work typically consists of disposable coveralls, gloves and/or boots. Protective clothing for O&M work can be selected by the APM or the worker, depending upon the O&M procedures. Protective clothing options that are typically used are

APM 1...
continued

discussed in Worker General Procedure W7. The protective clothing option selected might depend in part upon the decontamination procedures to be used and the type of work area preparation or enclosure.

Decontamination procedures typically used for O&M work include HEPA vacuuming on a drop cloth, changing in a

change room, or showering. Worker General Procedure W15 explains the decontamination process for each option. The APM might also determine whether boots, gloves, hardhats or other protective equipment is needed for O&M tasks. Protective clothing selections made by the APM should be recorded on the Maintenance Work Authorization Form.

APM 2

Work Scheduling Level B and C work should be scheduled for a time when the work area will not be in use and can be closed off to anyone other than trained workers, or other authorized personnel. If an area is always occupied, plans should be made to isolate the work area from building occupants using visual and/or physical barriers. If a special work area arrangement is required, it might be beneficial to provide a sketch to the workers showing how the area is to be set up. If respirators are used for Level A activities, it might be desirable to vacate

the area to avoid concerns resulting from a worker in a respirator working within sight of unprotected workers/occupants.

Scheduling of work might be affected by notification requirements. All notification requirements should be met before work is scheduled. Under certain circumstances, some emergency work can be performed prior to the filing of a notification. Review regulations and contact federal, state and local regulatory agencies concerning notification requirements for emergency work.

APM 3

Federal, State and Local Notifications The Asbestos Program Manager, or his designee, should file all notices required by federal, state and local regulations prior to the start of any O&M activities that are governed by these regulations.

Federal Notifications Federal requirements for notification are set forth in the National Emission Standards for Hazardous Air Pollutants (NESHAP) rules and the EPA Worker Protection Rule. For demolition and renovation work, the latest NESHAP revisions are contained in 40 CFR 61.145 (a) and (b). A ten working day federal notification is required for renovation work if the combined amounts of regulated asbestos-containing material (RACM - see glossary or NESHAP for definition) to be stripped, removed, dislodged, cut, drilled or similarly disturbed is over 260 linear feet (80 linear meters), 160 square feet (15

square meters) or 35 cubic feet (1 cubic meter) for any single project. EPA's NESHAP rules specifically warn that "single projects" cannot be subdivided into smaller projects in an attempt to avoid notification requirements.

Also, if the combined estimated quantities of RACM to be removed or stripped in individual nonscheduled operations during a calendar year (January 1 through December 31) exceeds the amounts listed above, a NESHAP notice must be submitted at least ten working days before the end of the calendar year (e.g. December 15) preceding the year for which notice is being given. A new written notice must be filed with the EPA if the start date for a project is revised (earlier or later) from the date filed in the original or a previous notice. A notice must be updated if the amount of asbestos affected changes by 20 percent or more.

If wetting of RACM during removal

APM 3..
continued

would unavoidably damage equipment or present a safety hazard, written approval from the EPA is required for alternative emission control methods (dry removal).

The NESHAP notification requirements for emergency renovation work are set forth in 40 CFR 61.145 (a) and (b). More information on emergency work is included in General Procedure APM10.

See Appendix I (2.B and 2.D) of this manual and the NESHAP regulations for details on Federal notification requirements. Additional requirements might also be included in state or local regulations.

State and Local Notification Requirements

State and local notification requirements vary greatly. Many states and localities have notification requirements that are more stringent than the federal requirements. State and local requirements concerning permits for any repair or renovation work must be reviewed. State and local requirements must be complied with before work is scheduled and commenced. The EPA Regional Contacts (listed on page 37 in the Green Book) can provide information on obtaining copies of state and local regulations.

APM 4**Notification of Personnel**

Persons who use, occupy, or are affected by an area where ACM work will occur should be notified prior to the start of the work. OSHA regulations include mandatory notification of certain personnel prior to the performance of work regulated by OSHA. The following employers should be notified about the presence, location and quantity of ACM or PACM:

- Prospective employers applying for or bidding for work,
- employees of the owner,
- all employers on multi-employer work sites,
- tenants occupying areas.

This notification is required if these employers or their employees will be performing work in or adjacent to areas

where ACM or PACM is located.

Notification of personnel is usually not necessary for Level A O&M activities as these activities do not disturb ACM. Personnel should be given information about the specific work to be performed, the work schedule, precautions being taken, what will be visible during the work, and that posted warning signs must be obeyed. Section 4 of the Green Book includes information on occupant, tenant and worker notification of the presence of ACM that might be helpful to the APM.

If O&M work occurs frequently, or for Level A Tasks where notification is needed, a general notice to affected personnel might be more convenient than notifying these personnel each time work occurs. State and local regulations may also include personnel notification requirements.

APM 5

Assigning Workers Workers assigned to perform O&M work should have training and experience in the skills and techniques required for the type of work to be performed, training in applicable asbestos O&M procedures, the O&M plan for the facility, and site-specific building conditions. The EPA Green Book gives guidance concerning

the level of training recommended for conducting different types of O&M activities. EPA and OSHA offices might be able to direct the user to listings of training providers.

The AHERA regulation for schools includes required O&M training and outlines a minimum training program.

APM 5
continued

The OSHA construction standard contains minimum training requirements for construction workers (including maintenance and custodial workers) who disturb or contact ACM. Paragraph (k)(8) of 29 CFR 1926.1101 provides minimum training requirements for maintenance workers involved in Class III and IV work, and for workers whose only involvement with ACM is Class II work encompassing resilient floor covering operations. State and local regulations may impose training requirements for O&M activities. Verify that state and local requirements are met before scheduling work. Additional training might be desirable for performing frequent O&M work or certain O&M tasks. Before workers are assigned to O&M work, the APM should verify that their training, respirator fit tests and medical surveillance are current and in

compliance with regulations (where applicable) and the requirements of work practices to be used. Appendix I in this manual gives guidance on where to find applicable regulatory information and Green Book guidance on these topics.

Depending upon applicable regulations (such as OSHA, and NESHAP, state or local), a designated trained or "competent person" might be required to perform or supervise certain aspects of the work (see Appendix I for more information). OSHA requires that a competent person perform the initial exposure assessment and to make frequent and regular inspection of the jobsite for all operations covered under the standard. Section 4 of this manual discusses factors to consider when determining the number of workers required for an O&M activity. Once workers are selected for a task, the APM should review the work practice with the workers, if needed.

APM 6**Developing the Air Monitoring Program and Assigning Air Monitoring Personnel**

Note: This section is not intended as a substitute for a complete Air Monitoring Program that is needed for O&M work. This section notes air monitoring issues that the APM needs to address for O&M work.

Owners might choose to use an outside consultant to perform air monitoring for O&M activities. In certain cases, where frequent O&M activities are performed, the O&M program might include having one or more designated trained workers perform air monitoring during O&M activities. In either case, an Air Monitoring Program should be developed by the air monitoring personnel or consultant and the APM for O&M activities. The Air Monitoring Program should specify when air monitoring will be performed, the types of monitoring (personnel, background, area, clearance, periodic, and/or initial), analysis methods,

training requirements for monitoring personnel, and procedures for maintaining data from O&M activities, including any data required for a negative exposure assessment. Air monitoring data should be considered when selecting the type of respirators for activities that use respiratory protection.

Training might be required by the Air Monitoring Program or state or local regulations, and could include a NIOSH air monitoring course, industrial hygiene training or other requirements. Training for persons performing air monitoring work should include hands-on training with the equipment to be used. Training for air monitoring that is currently available consists primarily of courses meeting the National Institute for Occupational Safety and Health (NIOSH) 582 requirements.

Air monitoring exemptions or requirements for a given work practice should be based on the Air Monitoring

Program and stated on the Maintenance Work Authorization Form. Exposure monitoring should be addressed in the Air Monitoring Program and is required for operations covered by OSHA regulations unless requirements for termination of monitoring have been met during program set up or after initial monitoring. Review the applicable OSHA standards in detail when developing air monitoring procedures for O&M work.

Exposure monitoring is required following changes in work practices, employees, employee skill levels, or other pertinent factors which could lead to the OSHA action level or exposure limits being exceeded. Personal monitoring should consist of samples to obtain an 8 hour time-weighted average (TWA), if possible, and excursion limit (EL) monitoring samples. All analysis for OSHA compliance should be by phase contrast microscopy (PCM) using the OSHA Reference Method (ORM) (29 CFR 1926.1101 Appendix A) or NIOSH Method 7400 Method. Transmission electron microscopy (TEM) analysis will distinguish asbestos fibers from other fibers and might also be used if desired to supplement the PCM data required by OSHA. TEM analysis should be performed in accordance with the analytical method in the AHERA regulation (40 CFR Part 763 Appendix A) or Yamate Level II. TEM data cannot substitute for OSHA required PCM data unless approved by the local OSHA office.

The air monitoring performed for OSHA exposure monitoring does not distinguish between asbestos and non-asbestos fibers and cannot measure the short or thin fibers that may be detected using transmission electron microscopy (TEM) analysis. Short or thin fibers may be found in airborne asbestos levels generated during disturbance of asbestos-containing materials manufactured with

such fibers (e.g. resilient flooring), or where the disturbing process grinds fibers down (such as during sawing, sanding or grinding). Air monitoring data for OSHA exposure may not be an accurate predictor of TEM results. Clearance monitoring using TEM analysis is required by the federal government only under AHERA for applicable school projects involving ACM which is or becomes friable. Some TEM data indicate that workers may be exposed to short or thin fibers, which are not counted in air monitoring analysis under the OSHA standard, when engaged in activities that disturb ACM. If clearance monitoring requiring TEM analysis is specified, the results can be affected by short or thin fibers which may be generated when attempting to follow O&M procedures and/or by nearby job operations involving ACM.]

The sampling and TEM analysis of settled dust to evaluate areas for cleaning or precleaning prior to an O&M activity may be considered. Although current regulations do not require this type of testing, dust sampling is presented as an available analytical tool that may be used to make recommendations for cleaning and other corrective measures. Settled dust sampling can also be used during O&M activities to document disturbances of ACM during the activity. Additionally, settled dust sampling might be used as part of a clearance protocol for O&M work. Since no current regulatory standards for asbestos dust sampling have been set by government agencies, an APM might want to consult with experienced laboratories or consultants regarding the latest settled dust sampling procedures and protocols. Procedures in use to sample settled dust include microvacuuming (see dust and debris paragraph), surface wipe sampling, passive dust sampling and tape lift methods.

APM 7

Record keeping The Green Book recommends that the following records of O&M work be retained in permanent files:

- Inspection and Assessment Reports
- A copy of the O&M Program (initial program and all updated versions)
- The Work Practices Used
- Respiratory Protection Program
- Fiber Release Reports
- Job Request Forms
- Maintenance Work Authorization Forms
- Evaluations of Work Affecting ACM
- Reinspection/Periodic Surveillance Reports

For employers with employees engaged in asbestos-related work, federal regulations require that the employer retain:

- Personal Air Sampling/Exposure Monitoring Records
- Historical Data (used to qualify for exemptions from OSHA's initial monitoring requirements)
- Medical Records (for employees subject to a medical surveillance program)
- Employee Training Records
- Fit Test Records (for employees that use respirators)
- Data to rebut presumption that materials are asbestos-containing.

This O&M guidance manual also recommends that records be maintained for:

- Waste Tracking and Disposal
- See *Appendix D*.
- Air Monitoring Data
- Qualifications and Performance Records for Outside Contractors performing O&M work

If settled dust sampling is used it is advisable to maintain these records also.

OSHA requires that employers provide to each employee their record of exposure and medical surveillance under the Records Access Standard (29 CFR 1910.20) and the Hazard Communication Standard (29 CFR 1910.1200 & 1926.59) and the construction asbestos standard (29 CFR 1926.1101(n)). Also see the OSHA Asbestos Construction Rule (29 CFR 1926.1101), the EPA Worker Protection Rule (40 CFR 763 Subpart G) and the Green Book for details on Record keeping requirements. Note that state and local regulations may require that additional information be recorded and retained.

EPA recommends that building owners make available all written elements of the O&M program to the building's O&M staff as well as to tenants and building occupants, if applicable. Building owners are also encouraged to consult with their legal counsel concerning appropriate Record keeping strategies as a standard part of their O&M programs.

APM 8

Confined Spaces Confined spaces are often encountered in O&M work. Probably the most common areas encountered are crawlspaces, utility and pipe tunnels, manholes and chases. Special precautions are necessary for working in confined spaces. A confined space program, including an entry permit system, must be developed for use when Permit Required Confined Spaces must be entered. The APM or another staff person should be able to identify and assess

hazards associated with confined spaces. Procedures should be developed to address potential confined space hazards. NIOSH publication number 87-113 (July 1987), entitled "Guide to Safety in Confined Spaces", includes a checklist for safe entry into confined spaces, as well as general information on confined space issues.

Confined space hazards include, but are

not limited to:

- Oxygen deficiency or enrichment
- Engulfment
- Toxic atmospheres (gases, vapors and dusts)
- Hazardous chemicals
- Explosive atmospheres
- Heat stress
- Fire
- Retention of dust and smoke
- Insufficient lighting
- Flooding
- Electrical shock hazards
- Noise

Program elements should include:

- Entry and exit procedures
- An entrant, an attendant, and a person authorizing entry
- Standby/emergency rescue procedures
- Head protection (from bumps, scrapes, cuts, abrasions)
- Worker communication procedures
- Entry permit system
- Atmosphere monitoring
- Ventilation
- Isolation
- Respiratory protection

Depending upon the hazards present, monitoring and special precautions might be needed during the work to maintain a safe work area. OSHA regulation 29 CFR 1926.20(b) (General safety and health provisions, Accident prevention responsibilities); and 29 CFR 1926.21(b)(6) (Safety training and education, confined or enclosed spaces) are the regulations that cover confined spaces on construction work sites. 29 CFR 1910.146 governs requirements for confined spaces in general industry. This standard may be considered by Occupational Safety and Health Review Commission (OSHRC) and the courts when evaluating citation in the construction industry under the less specific construction standards. OSHA is currently considering extending the general industry standard to construction. The user of this manual might wish to obtain and review a copy of regulations cited above if confined spaces will be encountered in O&M work. Appendix H includes general information on safety considerations that should be reviewed if work will take place in confined spaces.

APM 9

Selection of Materials The Asbestos Program Manager should be responsible for the selection of certain materials used for O&M activities. This manual will not attempt to give guidance on the selection of all materials needed for O&M work. Information on selection of the following materials is provided:

- Polyethylene
- Lockdown encapsulants

Guidance on the selection of other materials should be obtained in training courses, or from reference materials, such as the NIBS Guide Specifications for Asbestos Abatement.

Polyethylene Various thicknesses, colors and types of polyethylene are available. 6 mil actual not nominal

thickness (0.15 mm) polyethylene should be used for all asbestos work. State or local regulations may require that certain thicknesses or types of polyethylene be used, or that fire resistant polyethylene be used. Two and four mil (0.05 and 0.10 mm) polyethylene is also available, but does not comply with OSHA requirements and should not be used for asbestos O&M work. Polyethylene is also available in fire retardant, anti-slip and anti-static types. Fire retardant polyethylene does not support flame as readily as standard polyethylene. However, some tests have shown only minimal differences in flame spread time between standard and fire retardant poly.

Anti-static polyethylene should be used around equipment sensitive to static electricity.

Lockdown Encapsulants

Lockdown encapsulants selected should be appropriate for the intended use. Use high temperature rated encapsulants for heating system components such as piping, boilers & flues. Lockdowns should also be compatible with any replacement materials, such as new fireproofing and flooring adhesive.

Compatibility should be verified prior to the start of work.

It is particularly important to make sure that any encapsulant used as a lockback will not adversely affect the fire protection rating of fireproofing materials. The fire protection ratings of spray fireproofing are based on full-scale fire endurance tests of fireproofed steel. Anything that differs from the tested assembly voids the rating, and could result in a fireproofing failure. Refer to the introduction to the work practices for surfacing materials for more information on the use of encapsulants with spray fireproofing materials. Some encapsulants have been tested with some fireproofing materials. Check with the manufacturer of the fireproofing that is to be used to find out if it has been tested

with any lockback encapsulants. Select an encapsulant and fireproofing material that have been tested together. Before approving use of an encapsulant get a written certification from the fireproofing manufacturer that the encapsulant is compatible with the fireproofing. Some fireproofing systems use an adhesive on steel before application of the fireproofing material. This adhesive can be used in lieu of an encapsulant as a lockback.

Lockdowns are available in clear or colored mixtures. Clear mixtures should be used where a colored encapsulant would be objectionable for appearance reasons. Colored encapsulants should be used (where possible) with a color chosen to indicate that an area has been locked down. If applying two coats, two different colors can be used to make complete coverage by both coats more easily observable. The color also allows a worker to see where encapsulant has been applied during the application.

Certain lock-down encapsulants can pose a problem in confined spaces and cause this work to require a confined space entry permit. The PEL's of certain components of lock-down encapsulants if applied inappropriately on in quantities exceeding the manufacturer's directions may cause a toxic atmosphere.

APM 10

Emergency Work and Dry

Removal O&M activities sometimes require that regulated asbestos O&M work be performed immediately to maintain operations and prevent other health or safety hazards. Emergency work is acknowledged in regulations and is permitted under certain conditions. The NESHAP regulations specify that a notification for emergency renovation operations must be postmarked or delivered "as early as possible before, but not later than, the following working day" (see regulation for full text). State or local regulations may have additional requirements.

Emergency work might involve activities (such as work around activated electrical equipment) where the use of wetting would result in equipment damage or a safety hazard. NESHAP permits work without wetting regulated ACM under certain conditions (see regulation for details). For facilities where dry removal work might be required, the APM should review regulatory requirements in advance with authorities having jurisdiction over the facility. OSHA requires the use of a self-contained breathing apparatus (SCBA) in emergency situation where asbestos fiber concentrations are unknown.

III. Worker General Procedures



Section III Worker General Procedures

This section includes detailed procedures for steps that are common to many of the work practices. These general procedures are referenced in the work practices and in worker and APM checklists. The general procedures should be reviewed in detail by all personnel using this work practices manual. If possible, the general procedures should be covered in O&M training related to the use of this manual.

The work practices and checklists refer the user to applicable general procedures for detailed information on how to perform a certain portion of the work. Once a user is familiar with the general procedure requirements, it might not be necessary to

review the general procedures each time an O&M activity is performed. However, the general procedures should be reviewed periodically by all workers and the APM to verify that the proper procedures are being followed.

Workers should report any suggestions or problems regarding these work practices to their supervisor, the Asbestos Program Manager (APM) or the APM's designee.

Users of the O&M Work Practices Manual should also review the General Safety Considerations information in Appendix H of this Manual.

Level A Checklist	58
Level B Checklist	59
Level C Checklist	60
W1 Tools, Equipment and Materials	61
W2 Preparing Amended Water or Removal Encapsulant	61
W3 Shut-off and Lockout of HVAC and Electrical Systems	62
W4 Securing Work Area	62
W5 Critical Barriers	62
W6 Putting on Respirators and Performing Fit Checks	63
W7 Putting on Protective Clothing	63
W8 Beginning and Conducting Air Monitoring	64
W9 Wet Wiping, HEPA Vacuuming and Steam Cleaning	65
W10 Polyethylene Drop Cloth	66
W11 Packaging and Labeling Waste	66
W12 Applying Lockdown Encapsulant	68
W13 Cleaning Tools, Equipment and Work Area	68
W14 Decontaminating Waste	69
W15 Worker Decontamination and Removal of Protective Clothing and Respirators	69
W16 Visual Inspection and Completing Air Monitoring	70
W17 Waste Transportation, Storage and Disposal	71
W18 Glovebag Removal	71
W19 Disposal of Contaminated Water	74
W20 Mini-enclosures	74

Note: Not all of the worker general procedures are used in every work practice.

Figure 5: Level A Worker Checklist Operations and Maintenance Work Practices

Level A work may contact ACM but not disturb it. If you encounter damaged ACM, or if the work could damage the ACM, stop work and notify your supervisor.

- Pre-Work Activities**
- Obtain and review copies from Supervisor or Asbestos Program Manager of:
 - Completed Maintenance Work Authorization Form
 - Work practice(s) to be used including personal protective equipment options
 - Work Notification(s) (as applicable)
 - Schedule for work
 - Review work practices and *General Procedure W1* and any other general procedures used in work practice.
 - Inspect work area for visible dust or debris. If present, stop work and notify APM.
 - Obtain recommended tools, equipment and materials as described in *General Procedure W1, work practice(s) item 2*, and Maintenance Work Authorization Form.
 - Move tools, equipment and materials to work area.
 - Shut off and lock out any HVAC or electrical systems to be worked on.
 - If required on Maintenance Work Authorization Form, put on respirators and perform fit checks - *See General Procedure W6*.

Work Practices Always use wet methods, HEPA vacuums, prompt clean-up and disposal of waste.

Prohibited practices: Do not dry clean-up dust and debris, or use compressed air or high-speed abrasive saws.

- Perform work per steps in work practice(s).

-
- Clean-Up and Tear-Down**
- Remove lockout tags (if used) & restart any HVAC/electrical system(s) that were shut off.
 - Return tools, equipment and remaining materials to storage area.
 - Notify Asbestos Program Manager or supervisor that work is completed & return documents to APM.

Figure 6: Level B Worker Checklist Operations and Maintenance Work Practices

Level B: is work that may disturb ACM, but where the OSHA PEL is not exceeded and release of ACM, dust and debris is confined to the immediate location of the disturbance.

- Pre-Work Activities**
- Obtain and review copies from Supervisor or Asbestos Program Manager of:
 - Completed Maintenance Work Authorization Form
 - Work practice(s) to be used including personal protective equipment options
 - Work Notification(s) (as applicable)
 - Schedule for work
 - Review work practices and referenced general procedures used in work practice(s).
 - Obtain recommended tools, equipment and materials - *See General Procedure W1 and work practice(s) item 2.*
 - Obtain required respirators as listed on Maintenance Work Authorization Form.
 - Move tools, equipment and materials to work area.
 - Shut off and lock out HVAC and electrical systems serving work area - *See General Procedure W3.*
 - Vacate and secure work area, such as by locking doors and/or setting up temporary barriers - *See General Procedure W4.*
 - Put on respirators and perform fit checks - *See General Procedure W6.*
 - Put on protective clothing - *See General Procedure W7.*
 - Air monitoring personnel begins air monitoring work (if required) - *See General Procedure W8.*
 - Preclean work area if visible dust or debris is present - *See General Procedure W9.*

- Work Area** Set up work area as required by work practice - *See General Procedure W10.*

Work Practices Always use wet methods, HEPA vacuums, prompt clean-up and disposal of waste. Prohibited practices: Do not dry clean-up dust and debris, or use compressed air or high-speed abrasive saws.

- Perform work per steps in work practice(s).

- Clean-Up and Tear-Down**
- Package and label asbestos waste for disposal - *See General Procedure W11.*
 - Apply lockdown encapsulant, where required, using garden sprayer, to surfaces where ACM was removed or disturbed - *See General Procedure W12.*
 - Perform ceiling panel replacement work or ceiling repair work if needed.
 - Clean tools, equipment and work area using wet wiping and HEPA vacuuming as appropriate and return tools and equipment to outside work area - *See General Procedure W13.*
 - Decontaminate packaged waste & move waste to outside work area - *See General Procedure W14.*
 - Workers decontaminate and remove protective clothing and respirators. If contaminated, dispose of protective clothing as ACM - *See General Procedure W15.*
 - Complete visual inspection. Complete air monitoring work - *See General Procedure W16.*
 - If feasible, get APM or designee to complete Evaluation of Work Form.
 - Transport waste to designated asbestos waste storage area - *See General Procedure W17.*
 - Remove drop cloth, clean with HEPA/wet methods or properly dispose of as contaminated.
 - Return decontaminated tools, equipment and remaining materials to storage area.
 - Remove lockout tags and restart HVAC/electrical system(s).
 - Restore normal accessibility to work area.
 - Notify Asbestos Program Manager or Supervisor that work is completed & return documents to APM.

Figure 7: Level C Worker Checklist Operations and Maintenance Work Practices

Level C: is work where ACM is disturbed and the PEL may be exceeded or ACM, dust, and/or debris may be scattered beyond the immediate location of the disturbance. Level C work must take place in an enclosure (glovebag or mini-enclosure).

- Pre-Work Activities**
- Obtain and review copies from Supervisor or Asbestos Program Manager of:
 - Completed Maintenance Work Authorization Form
 - Work practice(s) to be used including personal protective equipment options
 - Work Notification(s) (as applicable)
 - Schedule for work
 - Review work practices and referenced general procedures used in work practice(s).
 - Obtain recommended tools, equipment and materials -
See General Procedure W1 and work practice(s) item 2.
 - Obtain required respirators as listed on Maintenance Work Authorization Form.
 - Move tools, equipment and materials to work area.
 - Shut off and lock out HVAC and electrical systems serving work area -
See General Procedure W3.
 - Vacate and secure work area, such as by locking doors and/or setting up temporary barriers - *See General Procedure W4.*
 - Put on respirators and perform fit checks - *See General Procedure W6.*
 - Put on protective clothing - *See General Procedure W7.*
 - Air monitoring personnel begins air monitoring work (if required) -
See General Procedure W8.
 - Preclean work area if visible dust or debris is present - *See General Procedure W9.*
-
- Work Area**
- Perform all Level C work inside an enclosure (glovebag or mini-enclosure) Set up work area and decontamination facilities as required by work practices - *See General Procedures W5, W10, W18, and W20.*
-
- Work Practices** Always use wet methods, HEPA vacuums, prompt clean-up and disposal of waste
Prohibited practices: Do not dry clean-up dust and debris, or use compressed air or high-speed abrasive saws.
- Perform work per steps in work practice(s).
-
- Clean-Up and Tear-Down**
- Package and label asbestos waste for disposal - *See General Procedure W11.*
 - Apply lockdown encapsulant, where required, using garden sprayer, to surfaces where ACM was removed or disturbed - *See General Procedure W12.*
 - Perform ceiling panel replacement work or ceiling repair work if needed.
 - Clean tools, equipment and work area using wet wiping and HEPA vacuuming as appropriate and return tools and equipment to outside work area -
See General Procedure W13.
 - Decontaminate packaged waste & move waste to outside work area -
See General Procedure W14.
 - Workers decontaminate and remove protective clothing and respirators. If contaminated, dispose of protective clothing as ACM - *See General Procedure W15.*
 - Complete visual inspection. Complete air monitoring work -
See General Procedure W16.
 - If feasible, get APM or designee to complete Evaluation of Work Form.
 - Transport waste to designated asbestos waste storage area -
See General Procedure W17.
 - Remove drop cloth and/or mini-enclosure, clean with HEPA/wet methods or properly dispose of as contaminated.
 - Return decontaminated tools, equipment and remaining materials to storage area.
 - Remove lockout tags and restart HVAC/electrical system(s).
 - Restore normal accessibility to work area.
 - Notify Asbestos Program Manager or Supervisor that work is completed & return documents to APM.

W-1**Tools, Equipment and**

Materials The following is a list of tools, equipment and materials that are referenced in the work practices and are recommended to perform the work practices. Tools, equipment or materials that are unique to a certain work practice are listed under item 2 in each work practice. For frequent O&M work, it might be helpful to maintain an "O&M cart" containing the necessary tools, equipment and materials.

Tools and Equipment

- Utility knife
- Ground fault circuit interrupters (GFCI's), Extension cords and adapters - GFCI's should be used on any electrical equipment or tools used in O&M work where water might be in use or present in the work area.
- Lockout tags
- Temporary work lights
- Ladder or scaffold for elevated work
- Wet wipes or bucket with clean water for wet wiping
- Smoke test bulb and tubes
- Bone saw
- Wire cutters
- Tin snips
- Safety glasses

Abatement Equipment and Materials

- Polyethylene sheet
- Duct tape
- Disposal bags with labels
- High efficiency particulate air (HEPA) vacuum with hose, attachments and proper HEPA filter (wet/dry type needed for some work practices)
- Respirators (if required)
- Disposable coveralls (if required)
- Disposable towels or wet wipes
- Asbestos barrier tape
- Warning signs
- Garden sprayer with amended water or removal encapsulant (Level B and C practices) See general procedure W2.
- Aerosol cans or garden sprayer with lockdown encapsulant (Level B and C practices)
- Air monitoring pumps, cassettes and calibration equipment (if required)
- Frame for mini-enclosure or prefabricated mini-enclosure (Level C practices)
- Negative pressure machine (HEPA filtered exhaust fan) as required for size of enclosure (level C practices - could be negative pressure machine or additional HEPA vacuum)
- Manometer (if pressure differential measurements are desired)
- Glovebags (if required)

W-2**Preparing Amended Water or Removal Encapsulant**

Amended water or removal encapsulant solutions are prepared by mixing a measured amount of surfactant or encapsulant with clean water in accordance with the manufacturer's instructions. Surfactants and encapsulants materials might be considered hazardous substances. Containers of amended water or removal encapsulant should be labeled to identify the contents in accordance with

the OSHA Hazard Communication Standard (29 CFR 1910.1200). Review and comply with Material Safety Data Sheet (MSDS) before mixing and using these materials. Amended water or removal encapsulant should be mixed in a labeled garden sprayer unit prior to the start of an O&M activity. Some practitioners have reported that liquid dishwashing detergent might be used as a surfactant for O&M work. They have used a mix of 8 parts water to one part detergent.

W-3**Shut-off and Lockout of HVAC and Electrical Systems**

Any electrical systems that might be worked on or affected by O&M activities should be shut off, locked and tagged with electrical lockout tags at the circuit breaker panel or disconnect switch.

Affected systems include systems that could create electrical hazards during O&M activities that involve wetting.

HVAC systems in a work area, systems that serve a work area, or systems that will be worked on should be shut down during O&M activities. Level A activities

usually do not require HVAC shut down unless a work will occur on a system or a disturbance of asbestos will occur. Any air-handling systems (supply, return and exhaust) required to be shut down should be shut off, locked, and tagged with electrical lockout tags at the circuit breaker panel or disconnect switch.

Lockout tags should note when and why power is shut down and the personnel performing the lockout. There should only be one key for each lock used on lockout tags to prevent accidental reactivation of equipment.

W-4

Securing Work Area When asbestos fibers might be released, work areas should be vacated and secured (where feasible) by scheduling, locking doors (from inside the area if possible) or other means. If this is not feasible, access to the work area should be restricted, such as by asbestos barrier tape around the perimeter of the work area. If barrier tape is used to denote a work area, it should be placed 5 to 10 feet (1.5 to 3 meters) outside of any polyethylene protection used in the work area. Install barrier tape by taping or tying it to fixed objects.

Do not block access to any emergency exits, and when asbestos fibers might be released, post OSHA required "danger" signs at all entrances to the work area. For such projects, it might be desirable to have a visual barrier installed several feet in front of warning signs to avoid having warning signs readily visible to occupants. A "keep out of construction area" sign should be posted on visual barriers. A visual barrier would be arranged so that a person who goes past the visual barrier will then see required warning signs.

W-5**Critical Barriers**

Completely Separate the Work Area from other portions of the building, and the outside by closing all openings with sheet plastic barriers at least 6 mil (0.15 mm) in thickness, or by sealing cracks leading out of Work Area with duct tape.

Individually seal all ventilation openings (supply and exhaust), lighting fixtures, clocks, doorways, windows, convectors and speakers, and other openings into the Work Area with duct tape alone or with polyethylene sheeting at least 6 mil (0.15

mm) in thickness, taped securely in place with duct tape. Maintain seal until all work including Project Decontamination is completed. Take care in sealing of lighting fixtures to avoid melting or burning of sheeting.

Provide Sheet Plastic barriers at least 6 mil (0.15 mm) in thickness as required to seal openings completely from the Work Area into adjacent areas. Seal the perimeter of all sheet plastic barriers with duct tape or spray cement.

W-6**Putting on Respirators and Performing Fit Checks**

The procedures described below are based on the assumption that workers wearing respirators have been trained in the use of respirators and, for negative pressure respirators, fit tested, and enrolled in a medical surveillance program as part of a Respiratory Protection Program.

Respirators used should be approved by NIOSH and/or MSHA. These procedures are not a substitute for a Respiratory Protection Program in accordance with OSHA standard 29 CFR 1910.134 or regulatory requirements regarding respirators.

Wearers should inspect their respirators before each use of the respirator.

Respirators must not be damaged, have missing parts or be deformed in any way. The straps must be intact and well attached. Proper filter cartridges for the hazards to be encountered must be installed. Verify that filters have been replaced in accordance with the Respiratory Protection Program. Batteries for powered respirators should be fully charged. The respirator should also be cleaned if it was not cleaned after the last use. If any problems exist, the respirator should be repaired or replaced in accordance with the Respiratory Protection Program.

When putting on a respirator, the straps should be loosened before it is put on. Filter caps (such as those used on some

Powered Air Purifying Respirators) should be taped to the filter body or stored where it will not be lost. Powered respirators should be turned on and flow checked before the facepiece is put on. The respirator should be put on and then the straps tightened as recommended in the manufacturer's information provided with the respirator. Fit checks should then be performed.

Fit Checks Fit checks should be performed in accordance with the Respiratory Protection Program by each worker each time they put on a respirator. Both positive and negative pressure fit checks should be performed. When feasible, powered respirators should be checked with the motor unit turned off. A negative pressure fit check is done by donning the respirator and pulling the respirator straps so the unit fits snugly. Inhale gently while placing hands over filters to block off inhalation side. Respirator should pull to face and no air should leak in around face seal.

A positive pressure fit check is done by exhaling gently (without breaking respirator seal to face) breathing normally while blocking off the exhalation valve. The face piece should then expand away from face while exhaling.

Adjust respirator straps as needed to obtain a good seal of the facepiece to the face. If a good seal cannot be obtained, obtain a new respirator and perform fit tests again.

W-7**Putting on Protective Clothing**

Protective clothing for workers typically consists of disposable coveralls, gloves and boots. Coveralls should have hoods and booties attached. They should

provide complete coverage of the body with the exception of hands and face. Cloth coveralls that are cleaned by a facility equipped to launder asbestos contaminated clothing might also be used. Do not modify coveralls.

Protective Clothing Options Available for O&M Work Include

LEVEL A & B: If level A or B work is to be performed and the potential for exposure to asbestos-containing dust and debris is low and localized, use:

1. One disposable coverall with no street clothes, or
2. One disposable coverall over street clothes.

LEVEL C: Level C work is to be performed inside of a mini-enclosure and if potential for exposure to asbestos-containing dust and debris is moderate or dispersed, use:

1. Two disposable coveralls with no street clothes, or if street clothes are required, two coveralls should be worn over the street clothes. Preferably the

street clothes should be removed before the start of work.

When possible, street clothes should be removed in a changing area before protective clothing is put on. Protective clothing should be put on after respirators. The coverall hood should cover respirator straps.

Workers are encouraged to wear protective gloves that are duct taped at the cuffs to the protective coveralls. Eye, hearing, and head protection should also be used where needed. Rubber slip-resistant boots or other non-slip footwear is to be worn for all activities. (protective booties should cover feet inside the boots). Steel-toed boots should be used in areas where foot hazards exist. Do not use coveralls with loose foot coverings for activities that involve climbing ladders or working on scaffold.

Beginning & Conducting Air Monitoring During Work Practices

Note: This section is not intended as a substitute for a complete Air Monitoring Program and specific protocols needed for O&M work. This section notes air monitoring issues that need to be addressed by the air monitoring person.

Air monitoring during O&M activities can consist of personal monitoring, area monitoring and clearance monitoring. Air monitoring required for the work practice being performed should be listed on the Maintenance Work Authorization Form and be conducted in accordance with applicable regulations (such as 29 CFR 1926.1101 Appendix A), the O&M Plan and Air Monitoring Program. All air monitoring work should be conducted by a trained person assigned by the APM.

The air monitor person should calibrate, adjust, and record the flow rate of all air monitoring pumps to be used before air

monitoring is started for an O&M activity. General procedure W16 covers visual inspections and the completion of air monitoring at the end of the work.

Personal Monitoring To perform personal monitoring, attach a personal air monitoring pump to a belt worn by the worker. Attach an air sampling cassette to the hose from the pump. Route the hose up the worker's back and tape the hose to the worker's protective coveralls using duct tape. The cassette should be located with the open end facing downwards at approximately a forty-five degree angle in the worker's "breathing zone" at about collar level. Turn the pump on and record start time. The air monitoring person will retrieve or change the cassette when necessary, or when work is completed.

Area Monitoring Area monitoring is usually performed using high volume air sampling pumps. Place pumps inside the work area and outside the work area in occupied areas or areas where occupants could be exposed if fibers are released

W-8...Continued

from the work area. Pumps should be located where they obtain meaningful measurements of potential worker exposure during monitoring as well as measure any area contamination. Attach sampling cassettes to the hoses from the pumps and attach the cassettes to the top of tripod stands or other stable structures (do not use the pump as a stand due to its vibrations) to locate the sample at four to five feet (1.2 to 1.5 meters) above the floor. These cassettes should be located

with the open end facing downwards at approximately a forty-five degree angle. The air monitoring person will retrieve or change cassettes as needed or when the work is completed.

If any samples analyzed during the work exceed predetermined "stop work levels" specified in the O&M program, productive work shall be stopped, the area cleaned and additional engineering controls implemented, as necessary.

W-9**Wet Wiping, HEPA Vacuuming, and Steam**

Cleaning These work practices are used either to pre-clean the work area prior to start of work, or for cleaning surfaces as part of a work procedure.

Precleaning of work areas prior to the start of work is done to remove accumulated debris and dust that could be disturbed during the work. Precleaning might include picking up dust and debris with a HEPA vacuum, wet wiping non-porous surfaces, HEPA vacuuming surfaces that cannot be wet wiped, and cleaning any carpeted surfaces using steam extraction equipment. (Note: EPA has determined in a research study that HEPA vacuuming and steam cleaning of carpets does not completely remove asbestos contamination.) Precleaning might reduce the extent of cleaning required after the work and for clearances (if required).

The following work procedures are used for cleaning when required in a Work Practice.

Wet Wiping The procedures to be used for wet wiping are as follows:

1. Immerse disposable towel in bucket containing amended water.
2. Wring out towel and fold into quarters.
3. Wipe surface and refold to have a clean face exposed. Do not place

towel back into bucket or water will become contaminated and will need to be replaced.

4. Repeat step 3 until all faces of towel have been used. Obtain a clean towel if more wiping is needed.
5. Dispose of used towels in disposal bags.
6. Dispose of contaminated water as required by applicable regulations
-See general procedure W19.

HEPA Vacuuming The procedures to be used for HEPA vacuuming are as follows:

1. For floors, use a floor attachment with rubber floor seals and adjustable floor-to-attachment height. For furniture, fabrics or other surfaces use an upholstery attachment or brush attachment.
2. Vacuum hard or smooth surfaces with attachment about 1/16" (2 mm) above the surface.
3. Vacuum carpet or fabrics with attachment just touching the surface.
4. Vacuum all surfaces in parallel passes with each pass overlapping the previous one by one-half the width of the attachment.
5. Once surfaces are cleaned in one direction, clean a second time at right angles to the first cleaning.

W-9 *Continued*

6. Use crevice brush or other tools to clean irregularly shaped surfaces.

Steam Cleaning Carpet The procedures to be used for steam cleaning carpet are as follows:

1. Steam clean carpet using carpet tool.
2. Steam clean all surfaces in parallel passes with each pass overlapping the previous one by one-half the width of the

attachment.

3. Once surfaces are cleaned in one direction, clean a second time at right angles to the first cleaning.
4. Water from cleaning process should be treated in accordance with applicable regulations - *See W19.*

(Note: EPA has determined in a research study that HEPA vacuuming and steam cleaning of carpets does not completely remove asbestos contamination.)

W-10**Polyethylene Drop Cloth**

The NIBS Asbestos Abatement and Management in Buildings: Model Guide Specifications Section 01527 "Regulated Areas" provides information on the preparation of "a regulated area" for operations and maintenance work. Review of this additional information is encouraged.

Preparation of work areas for O&M activities typically involves demarcation of the work area, restricting access to the work area and the use of a polyethylene drop cloth.

Polyethylene Drop Cloth Preparing a work area with a drop cloth requires that a single layer of polyethylene be spread on the floor of the work area and taped or weighted in place. Do not use more than

one layer if ladders (or similar equipment) will be used, unless a hard surface, such as plywood is laid over the drop cloth. If floor is a soft material, such as carpet, use caution to prevent tearing of polyethylene under equipment. The drop cloth should cover an area large enough to catch falling debris. If work is to be performed at an elevated level, the drop cloth should be placed on the work platform, or extended at ground level beyond the immediate work location to catch any debris that might be generated. Note that the use of a drop cloth introduces potential slip hazards in the work area. Non-slip foot coverings are recommended where drop cloths are used. Drop cloths should be thoroughly cleaned if they are moved from one spot to another or reused.

W-11**Packaging and Labeling Waste**

Asbestos-containing waste material from O&M activities should be adequately wet in accordance with the NESHAP requirements (40 CFR 61.150). Verify waste packaging and other waste disposal requirements with the landfill that will receive the asbestos waste. Pre-labeled asbestos disposal bags should be used for asbestos waste disposal where possible, appropriate and permissible. Disposal bags should be collapsed by evacuating

the air from the bag with a HEPA vacuum in the work area or enclosure. Once collapsed, twist the bag to form a neck and wrap it tight with duct tape. Fold neck of bag over to form a loop, then again wrap duct tape around neck and loop.

Although not a federal regulatory requirement, asbestos waste is often placed into second disposal bag and sealed as described above. Label disposal bags as required by applicable NESHAP, OSHA and DOT regulations.

Asbestos waste that does not fit into disposal bags should be wrapped leak-tight in one or two layers of 6 mil (0.15 mm) polyethylene sheet. Each layer should be sealed tightly with duct tape. Label outer layer as required by regulations.

Sharp objects that might puncture polyethylene (such as floor tile) should be placed into cardboard boxes before wrapping in one or two layers of 6 mil (0.15 mm) polyethylene.

All waste should be labeled as required by federal, state and local regulations. Federal regulations requiring labeling of waste include OSHA regulations 29 CFR 1910.1200, 1910.1001 and 1926.1101, EPA's NESHAP regulation 40 CFR 61.150, and the Department of Transportation's Hazardous Materials Regulations 49 CFR 171 and 180. ACM packaging, with some exceptions, must meet general DOT and EPA requirements and be protective, marked and labeled. See Appendix I for further information. Review current labeling requirements with APM and disposal site. The OSHA requirements apply regardless of the amount of waste or measured exposure levels (see 29 CFR 1926.1101(k)).

Label Requirements Include:

OSHA 29 CFR 1926. 1101(k)(8) requirement:

DANGER
CONTAINS ASBESTOS FIBERS
AVOID CREATING DUST
CANCER AND LUNG DISEASE HAZARD

Department of Transportation (DOT) requirement DOT's shipping paper and marking format, used with some exceptions (see Appendix I) is:

RQ, Reportable Quantity, if 1 lb (.4 kg) or more friable asbestos

WASTE For waste material, if applicable

ASBESTOS Shipping name; for domestic transportation only.

MIXTURE For asbestos mixed with a binder or filler, etc.

9, Class 9, Miscellaneous Hazardous Materials, includes asbestos

NA2212 North American identification number; for domestic transportation only.

PGIII Packing Group; for domestic transportation only

LTD QTY, Limited quantity, if applicable.

200Z Total quantity of material describe; may abbreviate unit.

NESHAP requirement NESHAP requires that readily visible and legible warning labels as specified by OSHA be used on waste containers or wrapped materials (this is the same as the OSHA 29 CFR 1926.1101 label listed above). Waste material to be transported off the facility site must also be labeled with the name of the waste generator and the location at which the waste was generated.

OSHA requires leak-tight containers and labeling for Class II materials (Note that under the EPA NESHAP regulation these are Category I and II materials which are not regulated as long as the materials remain non-friable). For purposes of this O&M program, treat OSHA Class II materials as EPA regulated waste. Maintain OSHA required labels in place and dispose of as asbestos-containing waste in accordance with the NESHAP regulation.

W-12**Applying Lockdown**

Encapsulant A lockdown encapsulant should be applied to areas where ACM is removed. Lockdown encapsulants used should be tested per 1978 Battelle/EPA report "Tests for the Evaluation of Encapsulants for Friable Asbestos-Containing Materials". Encapsulants should be water resistant after curing and be Class "A" fire rated per ASTM 84-81A "Standard Method for Surface Burning Characteristics of Building Materials."

Lockdowns need to be compatible with any materials that will be installed over the encapsulant. Note that many lockdown encapsulants will act as an adhesive and could be objectionable on some surfaces when dry. Care should be taken to avoid getting encapsulant on or in HVAC units, HEPA vacuums, and negative pressure machines.

Lockdown is typically applied for O&M work using a garden sprayer. It should be applied in accordance with the manufacturers' recommendations in two light coats sprayed from opposite directions to seal all portions of surfaces including any exposed edges of remaining ACM.

DO NOT APPLY LOCKDOWN ENCAPSULANT ON FIREPROOFING OR TO STEEL THAT IS GOING TO BE FIREPROOFED, WITHOUT PRIOR APPROVAL FROM THE APM. The use of spray fireproofing is based on full-scale fire endurance tests of fireproofed steel. Anything that differs from the tested assembly voids the test, and could result in a fireproofing failure. Fireproofing is a non-combustible insulator of steel. Coating it or saturating it with an encapsulant could render it combustible and could reduce its insulating properties. This could cause the fireproofing to fail and as such voids the fire rating. The introduction of an encapsulant between the fireproofing and the steel could cause the fireproofing to fail. The bond of the fireproofing to the steel could be weakened causing the fireproofing to fall off, or the encapsulant could soften and allow the fireproofing to fall off during a fire. Unless the encapsulant has been tested and approved for use by the manufacturer of the fireproofing used, its use will void the fire rating of the fireproofing material.

W-13**Cleaning Tools, Equipment, and Work Area**

Clean tools and equipment using HEPA vacuuming and/or wet wiping procedures. Special attention should be given to cleaning extension cords, equipment wheels, vacuum hoses and other items that could pick up debris during the work. Tools and equipment should be placed outside of the work area as soon as cleaning is completed. Drop cloths and mini-enclosures can be cleaned or disposed of as ACM. Any items that cannot be fully cleaned (such as boots or tools) that might be used in another O&M activity should be placed into disposal bags, sealed and labeled as ACM. These bags should be wet wiped and then

placed outside of the work area with the other tools and equipment. Do not open bags containing contaminated tools, or open equipment such as a HEPA vacuum, except during another O&M activity or in a designated work area. HEPA vacuum hoses can be sealed with tape over both ends if the outside of the hose is clean.

Cleaning of the work area where an O&M activity is conducted consists of HEPA vacuuming and/or wet wiping (as appropriate) all surfaces in the area. HEPA vacuuming and wet wiping shall be performed as described in general procedure #9 above.

W-14**Decontaminating Waste**

Packaged waste should be HEPA vacuumed and wet wiped before it is moved out of the work area. Use the wet wiping and HEPA vacuuming procedures in general procedure #9. Packaged

waste should be placed on a sheet of polyethylene when it is moved outside of the work area. This polyethylene can be the outer portion of a drop cloth, if a drop cloth is being used.

W-15**Worker Decontamination and Removal of Protective Clothing and Respirators**

Removal of Protective Clothing (if used) Decontamination and removal of protective clothing following O&M activities should use the applicable procedure(s) described below:

LEVEL B REQUIREMENTS - (Removal of Protective Clothing When Drop Cloth Work Area Protection, or no Work Area Protection, is Used) HEPA vacuum all parts of protective clothing while standing at perimeter of drop cloth. Leaving respirator in place, remove protective clothing and fold inside out as it is removed. Place clothing, if contaminated, into a disposal bag and label as ACM waste.

LEVEL C REQUIREMENTS WHERE WORK IS PERFORMED INSIDE A MINI-ENCLOSURE OR OTHER PHYSICAL BARRIER - (Removal of Protective Clothing If A Mini-Enclosure and Change Room is Provided) HEPA vacuum all parts of protective clothing while inside work area enclosure.

If two disposable coveralls are used, remove outer coveralls in work area while leaving respirator in place. Fold coveralls inside out as they are removed. Move to change room, HEPA vacuum protective clothing, and remove second set of coveralls in the same manner.

If only one set of disposable coveralls is worn, remove in change room while

leaving respirator in place. Fold coveralls inside out as they are removed.

Place protective clothing, if contaminated, into a disposal bag and label as ACM waste. Wash hands, face and surface of respirator with clean water and disposable towels. Use caution to avoid breaking seal between respirator facepiece and face. Place disposable towels into a disposal bag. Remove respirator and follow procedures specified in Respiratory Protection Program for cleaning and storing respirator. Change respirator filters if needed or required and dispose of used filters as ACM. Put street clothes on and exit change room.

LEVEL C REQUIREMENTS - (Removal of Protective Clothing if an enclosure or mini-enclosure is used and a Shower is Available) HEPA vacuum all parts of protective clothing while inside work area enclosure. Remove outer coveralls in work area while leaving respirator in place. Fold coveralls inside out as they are removed. Move to change room. Wash hands and wet wipe face and respirator, HEPA vacuum protective clothing. Put on a clean set of protective coveralls over the coveralls already being worn to prevent any ACM debris or dust that may be on the coverall from falling off on the way to the shower. Proceed to shower with respirator still in place. At shower facility, remove protective coveralls, folding inside out during removal. Place clothing, if contaminated, into a disposal bag and label as ACM waste. Shower completely, and remove and clean respirator while showering as described below.

Street Clothes If street clothes are worn under protective clothing and are contaminated during the work, the street clothes should be HEPA vacuumed, removed during decontamination and placed into a labeled disposal bag. These street clothes should then be disposed of as ACM or taken to a facility that has equipment designed for cleaning asbestos-contaminated clothing.

Removal of Respirator The procedures described below are based on the assumption that workers wearing respirators have been trained in the use of respirators and, for negative pressure

respirators, fit tested, and enrolled in a medical surveillance program as part of a Respiratory Protection Program.

Remove respirator after removing protective clothing (if used). Before removing respirator, wash hands, face and surface of respirator with clean water and disposable towels. Use caution to avoid breaking seal between respirator facepiece and face. Avoid getting water into filter cartridges of respirator. Place disposable towels into a disposal bag. Remove respirator and follow procedures specified in Respiratory Protection Program for cleaning and storing respirator.

Visual Inspection and Completing Air Monitoring

Visual Inspection Conduct a visual inspection prior to the start of clearance air sampling. The person performing the inspection can be a worker if authorized by the APM. Verify that there is no debris or residue from removed ACM and that all visible dust or debris in the work area has been cleaned up. If visible residue, dust or debris remains, it must be cleaned up using wet wiping and/or HEPA vacuuming before clearance sampling is started.

Perform the visual inspection using procedures approved for use in the facility by the APM. If you have not been trained in visual inspection procedures notify the APM. The EPA's Purple Book and the American Society for Testing and Materials (ASTM) "Standard Practice for Visual Inspection of Asbestos Abatement Projects" (Document E1368-90) provide visual inspection procedures that might be helpful in developing O&M inspection procedures.

Air Samples Complete air monitoring work in accordance with Air Monitoring Program and requirements noted on a Work Authorization Form. Verify that removal areas have been encapsulated ("locked down"), that the work area, tools, and equipment have been cleaned, and that the area has passed a visual inspection. When air sampling cassettes are retrieved, the air monitoring person should record the stop time for the samples and check and record the flow rate of the air monitoring pumps. Samples should be analyzed on-site (for PCM analysis) if possible, or sent to a laboratory for analysis. When sample results are received, compare results to Air Monitoring Program criteria for work release or clearance. If sample results exceed criteria, the work area should be recleaned, reinspected, and then additional air samples should be obtained. If samples are equal to or below release criteria, tear down work can proceed. Collect air sampling pumps and equipment from work area and other locations when air sampling work is completed.

W-17

Waste Transportation, Storage and Disposal Transport asbestos waste from O&M activities to a designated storage area or an approved landfill after the work is completed. Workers transporting waste should follow Respiratory Protection Program recommendations concerning respirator requirements for transporting asbestos waste. Do not drag packaged waste. All waste should be lifted and carried, or transported in wheeled carts, when moved from one area to another. Packaged waste should be placed, not thrown or dropped, into vehicles, storage areas and the landfill.

Any asbestos waste that is not taken to a landfill should be stored in a secure, lockable area. Signage in accordance with NESHAP should be posted at the storage area and on vehicles used to transport

asbestos-containing waste material during loading and unloading. When asbestos waste in the storage area is taken to a landfill, it should be transported in accordance with all applicable federal, state and local regulations. Asbestos waste shipment records should be completed in accordance with the requirements in NESHAP Section 61.150.

The workers conducting the O&M activity should fill out part 1 of the waste tracking form included in Appendix D or an equivalent form. Once part 1 is completed and the waste is stored or taken to a landfill, the form should be turned over to the APM to complete part 2 and file with O&M records. NESHAP waste shipment records must also be completed (where applicable) and filed with waste disposal records.

W-18

Glovebag Removal (Also includes other types of prefabricated removal enclosures) Remove asbestos-containing material inside a glove bag according to the following procedures. Glovebags should be used only once and should not be moved to another location to perform additional removal work, or reused in any way. Use only 60" X 60" standard glovebags. Do not use glovebags on surfaces or equipment that is over 150°F. If you encounter a situation that requires a special type or size of glovebag, or if hot surfaces are involved, notify APM.

Other types of prefabricated removal enclosures include "glovebox" type enclosures, glovebags with self-supporting frames, and glovebags that funnel waste into standard disposal bags. Check with equipment suppliers for information on these enclosures.

Glovebags might be used with a framework for O&M work on flat areas such as surfacing materials. Note that significant asbestos exposures to workers

can result from the improper use of glovebags. Workers should obtain information on current regulatory requirements on glovebag use from the APM.

Procedure A. Glovebag Removal Procedures

Check area where the work will be performed. If damaged ACM is present (broken lagging, hanging, etc.), wrap in polyethylene and cover polyethylene with strips of duct tape for reinforcement. Place one layer of duct tape around the removal area where the glove bag will be attached. Also protect any damaged ACM outside the glovebag area that could be disturbed during the work.

Slit top of the glove bag open (if necessary) and cut down the sides to accommodate the removal area.

Place necessary tools into pouch located inside glove bag (or into a sleeve turned inside out). Tools needed typically include: scraper, bone saw, utility knife, disposable towels, nylon brush, abrasive pads, wire cutters, tin snips and pre-wetted lag cloth. Cut lag cloth to sizes needed to cover any ACM that will remain after glovebag work is completed.

Place one strip of duct tape along the edge of the open top slit of glove bag for reinforcement.

Place the glove bag around area to be worked on and staple top together through reinforcing duct tape. Provide 8-12" (200-300 mm) of space inside glovebag between removal surface and glovebag for working room. Secure glovebag to duct tape previously installed around removal area.

Use smoke tube and aspirator bulb to test seal. Place tube into water sleeve (two-inch [50 mm] opening to glove bag) squeezing bulb and filling bag with visible smoke. Remove smoke tube and twist water sleeve closed. While holding the water sleeve tightly, gently squeeze glove bag and look for smoke leaking out, (especially at the top and ends of the glove bag). If leaks are found, tape closed using duct tape and re-test.

If a negative pressure glovebag with a supporting framework and HEPA filtered makeup air port is being used, attach hose from an operating HEPA vacuum to glovebag to provide negative pressure in glovebag. Follow equipment manufacturer's instructions on use of negative pressure equipment.

Insert wand from garden sprayer with amended water through water sleeve. Duct tape water sleeve tightly around the wand to prevent leakage.

Insert arms into glovebag sleeves.

Remove any metal jacketing or covering over the area where removal is required

using tin snips and/or wire cutters. Fold in any sharp edges to avoid cutting the bag. Pierce any painted coverings to permit water to soak into the ACM.

Adequately wet material to be worked on with amended water and allow to soak in. Wet adequately to penetrate and soak material through to substrate.

Cut insulation section to be removed using bone saw or utility knife. Use caution to avoid cutting glovebag. Lift glovebag away from cutting area if necessary.

Throughout this process, spray amended water or removal encapsulant on the cutting area to keep dust to a minimum.

Remove insulation using scraper or other tools. Place pieces in bottom of bag without dropping. Rinse all tools with amended water inside the bag and place back into pouch or a sleeve of the glovebag turned inside out.

Using nylon brush, scrub pads, disposable towels and amended water, scrub and wipe down the removal area.

Seal exposed ACM around removal area using pre-wetted lag cloth or encapsulate with a bridging encapsulant. Encapsulate removal area with an appropriate lockdown encapsulant. Use suitable high temperature encapsulants for hot piping.

Wash down inside of glovebag with amended water and wipe as necessary to move all debris and residue to lower part of glovebag (below where bag will be twisted and cut).

Remove water wand from water sleeve, twist water sleeve closed and seal with duct tape.

From outside the bag, pull the tool pouch or sleeve away from the bag and twist pouch to seal it from rest of bag. Place duct tape over twisted portion and then cut the tool bag from the glove bag, cutting through the twisted/taped section.

Contaminated tools might then be placed directly into another glove bag without cleaning. Alternatively, tool pouch with the tools can be placed in a bucket of water, opened underwater, and tools cleaned and dried. Discard disposable towels and nylon brush with asbestos waste. Dispose of contaminated water as set forth in general procedure *W19* below.

Evacuate air from glovebag using HEPA vacuum: With HEPA vacuum operating and removed insulation in the bottom of the bag, twist the bag several times and tape it to keep the material in the bottom during removal of the glove bag from the removal area.

Slip a 6 mil (0.15 mm) disposal bag over the glove bag (still attached to removal area). With the hose of an operating HEPA vacuum inserted in the upper part of glovebag, remove tape or cut bag and open the top of the glove bag and fold it down into disposal bag.

Procedure B. Use of a Glovebag with Self-Supporting Frame

Glovebags on self-supporting frames can be used for some O&M activities on surfacing materials, and might be able to be adapted for other types of ACM. The general procedures for using these units are as follows:

Construct a rectangular or square frame of 1 1/2" (38mm) diameter PVC or ABS pipe. Supporting legs can be made of lengths of pipe and fittings as needed to achieve the required height. Proprietary frames with telescoping legs are available.

To install glovebag on the frame, fold top edge of bag over the frame sides and extend the open edge of the bag at least 10" (25 cm) beyond the frame. Secure the open edges to the rest of the bag using duct tape. Place tools and supplies needed (procedure above) in tool pouch inside glovebag.

Place frame and glovebag assembly below work location so that frame is close to, but not touching, ACM. Location and proximity of frame to ACM should allow for some movement without disturbing ACM during the work.

Insert wand of garden sprayer with amended water into bag and seal in place.

Cut hole in glovebag for negative pressure equipment hose. Negative pressure equipment could be a HEPA vacuum or small negative pressure machine. Install hose and seal in place. A prefilter might be needed to prevent any gross ACM debris from being drawn into the negative pressure device.

Install a hose from an operating HEPA vacuum into the bag in a position where it can be used during the work. Turn on negative pressure device and smoke test all sides of glovebag frame unit to verify that negative pressure is present. If sufficient negative pressure is not present, reduce clearance between ACM and frame (if possible), or add additional negative pressure device(s).

Insert hands into glove arms and wet ACM where work is required. Perform work as needed. Caution: If bag is overloaded with tools or other materials, bag might break or release from frame.

HEPA vacuum and wet wipe tools and inside of bag. Adequately wet any ACM debris in glovebag.

Slowly lower frame to allow tools to be removed from bag.

Gently remove glovebag from frame and twist to form a neck. Evacuate air from bag using HEPA vacuum and tape bag closed.

Remove garden sprayer wand, negative pressure device hose, and HEPA vacuum hose and seal holes with duct tape.

Place glovebag into a labeled 6 mil (0.15 mm) asbestos disposal bag and seal bag.

W-19**Disposal of contaminated**

water Contaminated water from O&M activities should be disposed of in accordance with all applicable federal, state and local regulations. Filtering might be required. If filtering is required, water should typically be filtered through a maximum 5 micron (5 µm) water filter before discharging water into a sanitary sewer system, if permitted. If a filter unit is not available at the work location, contaminated water can be put into

leaktight drums and transported to a location with filtering equipment. If a portable shower unit with filtering equipment is available, contaminated water can be emptied into the shower and filtered through the shower filter system. The NIBS Asbestos Abatement and Management in Buildings: Model Guide Specifications Section 01563 "Decontamination Units" includes a specification for filtering equipment.

W-20**Mini-Enclosures**

Note: Polyethylene work area protection is not to be used in place of other engineering controls and good work practices. Work practices such as wetting ACM, careful handling, local collection by HEPA vacuum and local exhaust ventilation should be the primary means of fiber control during O&M work. Mini-enclosures are intended to protect the environment, workers are protected by work procedures and engineering controls that prevent elevated airborne fiber levels, and by respiratory protection, protective clothing, decontamination procedures and other worker protection methods. State or local codes might require that fire retardant polyethylene be used for asbestos related work.

The NIBS *Asbestos Abatement and Management in Buildings: Model Guide Specifications* 01529 "Mini-Enclosures and Glovebags" of the NIBS specifications provides information on the set up of a mini-enclosure. Review of this additional information is encouraged.

Preparation of work areas for O&M activities sometimes involve the use of a mini-enclosure. Other techniques, such as the use of a glovebag taped over a self-supporting framework might be used as a substitute for a mini-enclosure where appropriate. For small amounts of removal work (such as removing a small

amount of fireproofing, or cutting a hole in asbestos-containing plaster) where an enclosure is desired or needed, a glovebag can be used in lieu of a full mini-enclosure.

Mini-Enclosure A mini-enclosure is usually a polyethylene enclosure around a work area. Mini-enclosures are sealed enclosures used to protect the facility environment as a secondary means to help, or attempt to, contain fibers or debris generated during the work.

Mini-enclosures also serve to provide a visual barrier between the workers and any other personnel around the work area. As noted above, careful work practices should be the primary means of fiber control during the work in order to prevent gross contamination of the mini-enclosure.

It is sometimes appropriate to extend mini-enclosures above ceilings, such as by using polyethylene sheet and framing taped together to provide enclosure around the work area. The mini-enclosure should not contact ACM covered surfaces. The construction will vary depending on whether the enclosure will be attached to pipes, conduit, metal hangers, or some other form of existing construction.

There are a variety of commercially available types of mini-enclosures, including prefabricated pop-up boxes and adjustable framework assemblies to

permit different sizes of enclosures to be constructed. Disposable liners for mini-enclosures (to facilitate set up and dismantling of the enclosure) are available from some manufacturers. It might be beneficial to construct or purchase a portable mini-enclosure unit that works for the typical conditions found in a given facility.

It is recommended that two workers be used to set up and operate mini-enclosures. To construct a mini-enclosure, erect a framework of wood, PVC piping or metal framing that will enclose the work area and be large enough for one person to work inside. The minimum width and depth of the enclosure should be at least 3 feet (1 meter). The height of the enclosure will vary depending upon the work to be performed and the height of the work area. A larger enclosure is preferable where space permits. However, if the enclosure is too large, the final cleaning process will require more time. A mini-enclosure can include a separate 3 foot by 3 foot by 7 foot (1 x 1 x 2.1 meters) change room, with curtain doorways, attached to the mini-enclosure for changing and removing protective clothing.

If an entire room will be enclosed for performing work, the framework is usually not necessary, unless wall surfaces will be damaged by tape used to support polyethylene. A room can be enclosed for O&M work by installing one layer of polyethylene sheet on the walls and floor of the room.

If the work to be performed is in an elevated location, the enclosure (and change room, if used) should be erected on a scaffold platform large enough to support the enclosure, change room (if used), and a step off area outside the enclosure.

Refer to OSHA regulations 29 CFR 1910.28 and 29 CFR 1926.451 concerning scaffold requirements. Any ladders

and/or scaffolds used must be built and used in conformance with the OSHA construction standards, and applicable state and local standards. *See Appendix I of this manual.*

Cover the floor and the framework for the enclosure and change room with one layer of polyethylene attached using duct tape. A second layer of polyethylene laid on the floor might facilitate clean up work, or reduce the possibility of tearing the polyethylene if equipment is used (do not use two layers under the legs of ladders). Construct curtain doorways between the change room and the enclosure and between the change room and the area outside the change room. A curtain doorway is made of three overlapping sheets of polyethylene. Attach sheets to framework at top and one side. The middle sheet should be attached on one side, and the inner and outer sheets attached on the other side. A sheet of polyethylene approximately 5 feet by 5 feet (1.5 meters by 1.5 meters) or larger should be installed outside the change room for use as a step off area and as a place to put decontaminated materials removed from the work area.

Mini-enclosures should be constructed with a ceiling of polyethylene if work will not be performed above the enclosure. If work is to be performed above the enclosure and the ceiling is not ACM, the enclosure should extend to and be sealed to the ceiling or grid system. If the enclosure is below an ACM finished surface, use one of the following methods:

1. If ACM cannot be contacted, the enclosure should be separated from the ceiling by a narrow space.
2. If ACM will withstand contact without damage and is in good condition, foam tape (1" (25mm) or thicker) can be placed on the top edge of the enclosure. Gently lift enclosure into place until sufficient

contact is made to provide a seal to the surface.

After enclosure is in place, check for, and clean up any debris generated by enclosure installation.

Mini-enclosures should be set up with a negative pressure system as described below to reduce the possibility of fibers being released from the enclosure and to filter the air inside the enclosure.

Negative Pressure System and HEPA Filtered Local Exhaust Ventilation:

Note: Certain configurations of negative pressure systems (pressure differential systems) are covered by patents. The APM should review applicable patent information regarding use of these systems. This manual uses the term "negative pressure system" as a synonym for "pressure differential system".

Mini-enclosures should be provided with a negative pressure system to reduce the possibility of fibers being released from the enclosure during the work, and to filter inside air discharged from the enclosure. Negative pressure inside mini-enclosures is commonly provided by a High Efficiency Particulate Air (HEPA) filtered vacuum or by negative pressure machines, depending upon the size of the enclosure. Pressure differential systems and suggested rates of air circulation in terms of air changes per hour are discussed in the "Evaluation" for specification Section 01513 "Temporary Pressure Differential & Air Circulation System" of the *NIBS Asbestos Abatement and Management in Buildings: Model Guide Specifications*. A HEPA vacuum will usually provide sufficient negative pressure for a small enclosure. Larger

enclosures might require a small negative pressure machine (HEPA filtered fan unit) to achieve a negative pressure inside the enclosure.

A negative pressure system for a mini-enclosure most commonly locates the HEPA vacuum or negative pressure machine outside the enclosure. The intake side of the unit is ducted to the enclosure through the vacuum hose or flexible duct material taped to a hole in the enclosure on the side opposite from the change room or as close as possible to where the work will be performed. The filtered exhaust side of the unit should be ducted to the outside if possible. However, most vacuum units do not provide a connection for an exhaust duct, and are commonly exhausted to the inside. Additional protection might be desirable for an area where air is exhausted inside a building. A work practice is provided for changing filters in HEPA vacuums and negative pressure machines (HEPA filtered exhaust fans) when needed. Filters should not be changed without following these work practices.

When HEPA filtered local exhaust ventilation is used in a work practice, this can be in addition to, or in place of, a negative pressure system. A HEPA filtered local exhaust ventilation system might replace a negative pressure system if the ventilation system provides adequate negative pressure in the work area. Some work practices use HEPA filtered local exhaust ventilation for fiber control where an enclosure is not used. A HEPA ventilation system can use a HEPA vacuum or negative pressure machine. The hose attached to the HEPA unit should be kept as close as possible to the location where ACM might be, or is, disturbed.

IV. Surfacing Materials

Work Practices



Figure 8: Surfacing Materials Location Illustration

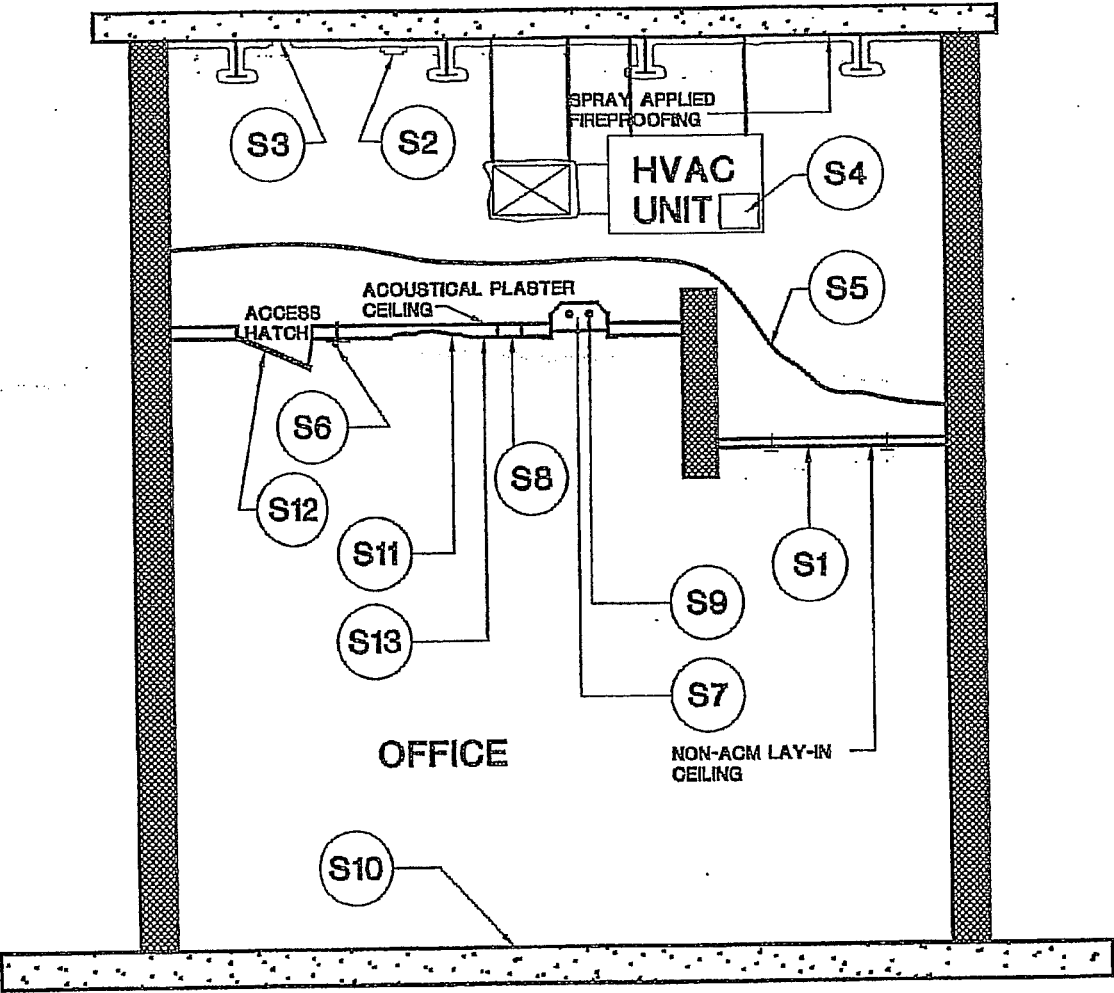

Section IV Surfacing Materials Work Practices

Surfacing Materials Location Illustration		78
<i>Code</i>	<i>Levels</i>	<i>Description</i>
S1	A B C	Moving one non-asbestos-containing ceiling panel below a plenum space that has exposed surfacing ACM
		87
S2	A B	Attach component to an ACM finished surface that is above a ceiling
		95
S3	B C	Remove a small amount of ACM surfacing above a ceiling
		99
S4	A B C	Work in ceiling plenum space where exposed surfacing ACM is present
		105
S5	A B C	Install wiring in plenum space where exposed surfacing ACM is present
		113
S6	A B C	Attach item to ceiling finished with ACM
		121
S7	A B C	Repair or replace item in surface finished with ACM
		129
S8	B C	Cut or drill hole in surfacing ACM
		136
S9	A B	Replace bulbs in light fixture attached to or in surface finished with ACM
		141
S10	A	Clean room with exposed surfaces finished with ACM
		145
S11	A B C	Repair damaged surfacing ACM
		147
S12	A B C	Accessing through an ACM finished surface
		152
S13	A B C	Painting surfacing ACM
		158

Figure 8 illustrates typical applications of these work practices.

GENERAL NOTES

Use of these procedures is limited to situations where the amount of waste generated is not greater in size than the OSHA limit on Class III work (operation will generate no more waste than will fit into one 60 inch by 60 inch glovebag or disposal bag).

The three primary types of surfacing ACM identified in developing work practice examples are fireproofing, acoustical plaster, and decorative textured finishes. Definitions of all three are included in the glossary in Appendix F.

Fireproofing

Fireproofing is one of the more important life safety systems in a buildings. Any action that compromises the fireproofing could, in the event of a fire, result in injury or death to building occupants or firefighters. The design of an asbestos O&M program that affects fireproofing must have as its starting point the steps necessary to maintain the fire safe integrity of the fireproofing system.

Fireproofing maintenance: The facility may have in place a program for maintaining the fireproofing system. If this is the case, the asbestos O&M needs to add the necessary asbestos control and worker protection elements to this existing program. The program for maintaining the fireproofing should include information on:

- The required fire rating of each fireproofed building element.
- The thickness of the existing spray fireproofing material that must be preserved in order to provide the needed fire rating.
- Specific application requirements (e.g. requirement for wire lath, bonding adhesive, or surface coatings) that may need to be preserved during work that impacts the system.

Patching Fireproofing: The system used to patch any locations where the existing fireproofing is removed during a maintenance activity needs to be designed. There may be separate requirements for each required fire rating and each building component. The design for the patching system should include:

- The type of fireproofing patch material to be used. The material should be specifically designed as a fireproofing patch material, or at least approved by the manufacturer for that purpose. The material needs to have a UL fire endurance test for the particular application. It must be compatible with the existing fireproofing system. The designation of a patching material should be made by a specific brand name rather than a generic designation.
- Thickness required for each needed fire rating.
- Surface preparation requirements. This needs to include consideration of compatibility with paints and primers that already exist in the building or that may be added as part of maintenance activities, and asbestos encapsulants that may be applied as part of the asbestos O&M.
- Application instructions. The material should be approved for application by hand.

Design of the fireproofing maintenance and patching requirements affect the life and safety of building occupants, and as such should be designed by a licensed

architect or engineer. These should be put in the form of a work practice and included with the asbestos O&M.

The asbestos O&M should add the necessary asbestos control and worker protection measures to the program to maintain the facility's fire protection.

Wetting: Wetting or surface misting with amended water is one of the most common asbestos control procedures. Most fireproofing materials are fairly forgiving of being wetted. However, fireproofing is an essential life-safety system and should not be carelessly tampered with. During design of the O&M program check with the manufacturer of the fireproofing about the wisdom of wetting the material with what is essentially soapy water. If the manufacturer is not available then follow the cautious route and restrict wetting to a surface misting. Care should also be used to avoid wetting materials so much that problems with the HEPA vacuum are created. Many HEPA vacuums have paper bags as their first filter. Wet material can cause this bag to fail creating problems with emptying the HEPA vacuum, and possibly prematurely clogging the secondary filter, or even compromising it. In no case should a removal or penetrating encapsulant be used for this purpose unless it has a specific UL test rating. See Underwriters Fire Resistance Directory, current edition, for further information and ratings.

Lockback encapsulants: Beginning with its 1989 edition, Underwriters Laboratories requires all components of a fireproofing system to be subjected to an E-119 burn test. This includes any primers (an encapsulant is a primer in this application). A primer (encapsulant) incompatibility could cause the fireproofing to fall off and leave the steel exposed and unprotected. If the encapsulant affect the bond of the

patching material, it could fall off. If the encapsulant softens too much when heated, it can cause the fireproofing to fall off during fire conditions. Some encapsulant manufacturers have testing their products with common fireproofing materials. The designer must select a fireproofing patching material and encapsulant that have been tested together. Otherwise there is a real possibility of a fireproofing failure, and the installation won't conform to the test criteria and the installation will not have a UL rating. Since so many local codes and Fire Marshall requirements refer to the UL criteria, the liability consequences of

installing an unrated system could be devastating.

- If the steel in the building was primed prior to fireproofing, The patching material must be compatible with both the existing primer and any primer that may be applied during maintenance activities. In this instance the primer can be used for the lockback.
- Some fireproofing systems have a adhesive/sealer that can be used as a lock-back. This is preferable to use of a lock-back encapsulant as it avoids encapsulant compatibility issues altogether.

Acoustical Plaster

Acoustical plasters have both an engineering and aesthetic function. These functions should be preserved and maintained by the O&M program.

Acoustical: The typical asbestos-containing acoustical plaster has a relatively open composition that allows sound waves to penetrate into and through the plaster. If the plaster is on a solid substrate such as a scratch coat or deck, then the sound reflects around inside the acoustic plaster and is absorbed (actually turned to heat). This affects primarily high frequency sounds. This affect can be measured and is expressed in terms of a noise reduction coefficient (NRC) rating. The noise reduction coefficient and the particular frequencies affected are important in the design of public assembly and performance spaces. The intelligibility of speech and clarity of music are impacted if the NRC rating is changed. If the surface is painted, the paint may seal the surface of the plaster so that sound can no longer penetrate as well. This will reduce the absorption of higher frequency sounds and allow greater reflection of these sounds. The change is

normally described as being more live, brittle, bright, or harsh. A simple change like painting or application of an asbestos encapsulant can dramatically change the space.

Aesthetic: Acoustical plasters typically have a sandy or textured surface. Even when painted the texture of these materials usually echoes through the paint film. During O&M activities and patching and painting should be conducted in a manner that matches the original surface. This can be accomplished by specifying a particular patching material and method of application. It is possible that the application of the patching material could sufficiently impact on the asbestos-containing plaster that this could affect the O&M Level appropriate for the activity. For example, the blending of a sand finish patch into an existing asbestos-containing acoustical plaster could disturb the ACM enough to turn a Level B work practice into a Level C.

Wetting: Many of the work practice require that the acoustical plaster be

misted with amended water. If not done carefully this could stain the surface. Stains result from two processes. If lightly dampened, impurities left behind when the water evaporates can stain the surface. If the surface is over wetted, fine material in the acoustical finish can be suspended by the water, or water soluble components may dissolve in the water. These suspended materials migrate to the margins of the wet spot and are deposited in a ring-like stain as the water evaporates. Staining can be avoided by restricting the amount of water used to what is necessary for asbestos control purposes. During design of an O&M procedure wetting procedures should be tried out on a surface in a hidden or

inconspicuous place to determine how wetting can be accomplished without staining. If staining is a problem the O&M designer may want to experiment with the use of distilled or demineralized water to eliminate staining from impurities in the water.

When selecting work practices for a surfacing material it is important to distinguish between situations where the material is in its original condition and those where it has been encapsulated or coated with layers of paint. Different work practices may be necessary for each situation. This should be clearly described in each work practice.

Decorative Textured Finishes

Decorative textured coatings do not have an acoustical function. The appearance of these materials should be maintained in the same manner as for work on acoustical plasters.

Designing and Implementing Work Practices

An O&M program will be easier and more practical to implement and more cost efficient if it is designed so that the majority of work can be performed without enclosures. For this to happen, each work practice needs to be developed to the point that there is no airborne exposure to asbestos (as defined by OSHA). In terms of the OSHA construction standard this means that a Negative Exposure Assessment (NEA) must be made.

In general, developing asbestos control procedures used during the work to the extent that Level A and B controls can reliably control airborne fiber levels and control the spread of ACM dust and

debris will result in a safer and more economical O&M program. Limit the use of Level C work practices to outside abatement contractors unless these procedures will be used on a routine basis.

The work practices given in this manual are examples of procedures that are typically useable for the situations described. The level of training, experience and skill of the staff performing the work, and the exact type of material and material conditions will vary from facility to facility. The O&M designer needs to adjust the work practices in the example to work for the specific materials and workers in a facility.

Paint usually needs to be removed prior to welding operations. Usually paint on structural steel is lead-based. Lead-based paint O&M work practices will need to be developed for this work and coordinated with the asbestos O&M program. Refer to the NIBS publication "Operation and Maintenance of Lead-Based Paint" for information on setting up an O&M program and for appropriate work practices.

Work that occurs in the vicinity of an ACM surfacing treatment, but does not contact it and will not disturb it, is not given a level designation but requires control to insure that a disturbance does not occur. This control can be accomplished by designating spaces such as above ceiling plenums as "Controlled Areas." ACM surface treatments in the vicinity of work but which do not need to be contacted should be designated as "Controlled Systems." Exposure monitoring is not required for these activities as ACM is not being contacted. Awareness training is needed to inform workers about the location of the ACM, and to advise them to avoid contacting it.

Level A work is an OSHA Class IV activity, where an ACM surfacing treatment is contacted but not disturbed, and a negative exposure assessment (NEA) has been made. Careful handling, wet methods, HEPA vacuums, prompt clean up and disposal, and awareness training for workers is required. Respiratory protection is not required by OSHA for this level of work, but is an option that the designer should consider. No area protection is required for this level of work.

During design of the O&M procedure, a Competent Person (as defined by OSHA) must make a determination that the exposed surfacing ACM is in good condition and that contact with the material without disturbance will not

cause an exposure to a worker that is above the PEL.

For work above ceilings or a similarly inaccessible space a competent person must make a determination that the exposed surfacing is in good condition, and that there is no ACM, debris or dust on top of the ceiling tiles or elsewhere in the plenum where it might be disturbed.

- **Design:** During design of the O&M procedure, the designer (who must be a Competent Person as defined by OSHA) must make a determination that the ACM is in good condition and that it will not be disturbed by the work, and that there is no debris or dust on top of ceiling tiles or other locations where it could be disturbed during the work.
- **Implementation:** The Asbestos Program Manager (APM) or somebody designated by the APM should be qualified as a competent person so that someone is available when new situations come up. Ideally the person that is currently in charge of assigning work to the maintenance staff should be this competent person.

Level B work is an OSHA Class III activity on an ACM surfacing treatment where the material is disturbed but a negative exposure assessment has been made. Level B work practices should be used for work that can be accomplished without generating airborne fiber levels in the breathing zone of workers that are above the PEL, that does not spread visible dust and debris from the ACM, and that is accomplished without TSI or surfacing ACM being drilled, cut, abraded, sanded, chipped, broken or sawed. The "disturbance" of the ACM in this instance is usually the removal of a small quantity of material to permit repair or maintenance work, or penetration by a

fastener. OSHA requires respiratory protection for work that disturbs surfacing treatments even if the PEL is not exceeded. Drop cloths are not required by OSHA, but are a practical necessity for this type of work.

WARNING: The Level B work practices in this manual cannot be used until a negative exposure assessment has been made. Level B work practices are performed without an enclosure. OSHA does not allow work that disturbs surfacing ACM to be performed outside of an enclosure unless there has been an NEA.

- **Design:** Work practices such as careful handling and wetting, are used to reduce fiber release. Local exhaust ventilation using a HEPA vacuum is used to collect fibers at the point of generation. Frequently, the wand of an operating HEPA vacuum is used as a tool to remove the ACM. The HEPA vacuum not only collects the removed material and contains it inside the vacuum, but also collects any released airborne fibers. The HEPA vacuum accomplished localized cleaning of the air in the vicinity of the work when used in this manner, or if held near the location of work that disturbs ACM.

The designer selects the work practice in this section that most closely matches the work to be accomplished. The work practice is modified as necessary to accommodate conditions in the facility. If the work is on fireproofing, the specific requirements for maintaining integrity of the fireproofing are added. The work practice must then be tested. This should be done by having the workers that will be performing the work follow the procedure. Normally, unless there is exposure data is available, this testing will have to be

performed inside an enclosure. During the test, the work practices are adjusted as necessary until exposures are reliably kept below the OSHA PELs. The designer, who must be a competent person, can then make a negative exposure assessment. If the facility has requirements for area samples, these are monitored during the test.

- **Implementation:** Each time that work is assigned the asbestos program manager (APM) (who must also be a competent person) must evaluate the work area make a determination that the conditions at the specific job site are equivalent to those that existing during development of the work practice, so that the work practice is applicable.

Level C work is an OSHA Class III activity on an ACM surface treatment where the work includes drilling, cutting, abrading, sanding, chipping, breaking, or sawing; or there is no negative exposure assessment (the PEL may be exceeded). In this instance careful handling, wetting, and use of HEPA vacuums is not sufficient to prevent the escape of airborne fibers, dust and debris, and some sort of enclosure is needed to protect the environment. Note that a mini-enclosure protects the environment, but requires that work be performed in a contaminated environment and as such may actually increase the exposure to workers. Glovebags reduce exposures to both workers and the environment. Workers need to be protected with respirators, protective clothing and decontamination procedures. OSHA requires respiratory protection, an enclosure and other worker protection measures for this type of work.

Training as abatement workers is more adequate for those performing Level C work in a mini-enclosure where exposure to elevated asbestos levels and the need

for a wet decontamination is possible. Frequently, O&M programs will avoid the use of level C work practices. If level C work is infrequently encountered, it is best to limit this type of work to outside abatement contractors who have workers accustomed to working in environments with elevated asbestos levels.

- **Design:** Initial monitoring needs to be conducted to determine what respiratory protection and other worker protection requirements will be.
- **Implementation:** Periodic monitoring must be performed to validate the selection of respiratory protection.

Work Practices

Careful work practices should be the primary means used to prevent releases of asbestos fibers during O&M work. Such practices include control measures such as careful handling, wetting and local exhaust using HEPA vacuums that control or collect fibers at the source. The goal of all asbestos O&M work should be to prevent any exposure of the worker and unnecessary contamination of the work area, drop cloths, mini-enclosures and other secondary control devices. Mini-enclosures should never be used to excuse sloppy work or creation of "bigger" messes.

Some work practices in this manual call for wet ACM to be scraped directly into the nozzle of a HEPA vacuum or to even use the nozzle as a tool to remove wetted ACM. This is very effective in controlling the release of airborne fibers or ACM debris. To use this type of procedure, use a HEPA vacuum that can handle wet waste (wet/dry vacuum) and that has enough capacity to hold waste generated during removal operation should be used. In some O&M programs,

the HEPA vacuum is used as the primary storage facility for removed ACM. Sucking ACM down a HEPA vacuum hose has a tendency to leave residue on the inside of the hose. This is alright if workers are trained to seal the hose before turning off the vacuum as routine procedure. There should be a periodic washing out of the hose with amended water. This can serve to add extra water to the collected waste at the time the HEPA vacuum is emptied.

If there is frequent need for work in a location where ACM will be disturbed by the work, (for example passing cables beneath a fireproofed beam that is close to the ceiling) it is prudent to install a barrier, sleeve or conduit to allow easier future access past the ACM. If this is done in a return air plenum the barrier, sleeve or conduit should be metal to avoid adding combustible material which may create a fire safety and code issue.

Limits

The amount of material disturbed by O&M activities should be limited. Level A work should generate no waste at all. Level B activities should be limited to work that will disturb a very small amount of material. Level C work should be limited to situations where the amount of waste generated is not greater in size than

the OSHA limit on Class III work (operation will generate no more waste than will fit into one 60" by 60" glovebag or disposal bag). It is standard industry practice not to fill these bags more than one-third full, to allow for proper sealing and to guard against breakage.

S1 . Summary

Moving one non-asbestos-containing ceiling panel below a plenum space that has exposed surfacing ACM.

Summary

These work practices cover situations where access is needed into a plenum above a non-asbestos-containing ceiling which is installed below exposed surfacing ACM. If debris and/or dust has fallen from the ACM and has collected on top of ceiling tiles, it could be disturbed when a tile is lifted out. This disturbance could release asbestos into the air. If the tile impacts ACM when it is lifted this could release debris, dust and airborne asbestos. The work practices are intended to prevent these disturbances. Different levels of work practice will be needed depending upon the amount of debris and dust that is on top of the ceiling:

Maintenance staff employees should be instructed not to remove ceiling tiles below asbestos-containing materials (ACM) without wearing the proper respiratory protection, clearing the area of other people, and observing asbestos waste disposal procedures. Personnel performing this work should be properly trained and protected.

Level A: Level A work practices should only be used in situations where: the ACM surface material is in good condition, there is no ACM dust and/or debris on top of ceiling tiles, and ACM above the ceiling will not be disturbed when the tile is lifted. The O&M program designer (who must be an OSHA competent person) will need to make a determination that lifting out a ceiling tile could not cause an exposure to a worker. This determination should be made based on the training, skill and experience of the workers; the condition of the ACM

surfacing material; and current or future activities that might affect the ACM. The material should be periodically observed to determine if there has been a change in condition. If there is change in the activity impacting the ACM (For example, a roof rip off might dislodge some fireproofing from the underside of a roof deck) conditions in the ceiling plenum should be re-evaluated. This evaluation needs to be made by an OSHA competent person.

Note : Maintenance staff employees should be instructed: not to remove ceiling tiles below ACM without wearing the proper respiratory protection, clearing the area of other people, and observing asbestos waste disposal procedures. Personnel performing this work should be properly trained and protected.

Level B: If there is ACM dust or debris on top of the ceiling tiles or if ACM is going to be disturbed when the ceiling tile is lifted, but airborne fiber levels generated during the work can be maintained below the OSHA PEL, then Level B procedures are appropriate. Level B procedures for this purpose consist mainly of carefully lifting tiles to minimize disturbance, and use of a HEPA vacuum to pick up debris and collect any airborne fibers at the point of release. During design of the O&M program, a negative exposure assessment (NEA) must be made. Refer to the introduction for details on making an NEA. The O&M designer will have to determine if the conditions that prevailed during the NEA are representative of those in the facility.

S1 . Summary ... continued

In general, an NEA is possible with Level B work practices as long as ACM debris does not freely fall to the floor when a tile is lifted out. Level B procedures are capable of controlling small amounts of debris on top of the ceiling. However, this will be dependent on the skill, experience and patience of the worker. At some point, there will be enough debris that the controls cannot be depended on. This point will differ for each facility and work force. Usually, Level C procedures are resorted to when conditions are such that Level B procedures cannot be relied upon to control the fall of debris. The O&M designer will need to experiment during the performance of the NEA to determine where the cut off is for a specific facility.

Level B procedures are OSHA Class III work and as such are limited to activities where only a small amount of material is disturbed.

Level C: If there is enough ACM debris on top of the ceiling tiles that Level B work practices cannot reliably maintain airborne fiber levels below the OSHA PEL or if fallout of debris or dust can not adequately be controlled, then an enclosure will help protect the building environment, and Level C procedures should be used. Level B procedures should be used inside of a mini-enclosure as the primary control mechanism over fiber release. Airborne asbestos is released at the ceiling line when debris is disturbed by a lifting tile. The use of a HEPA vacuum at the point of disturbance

will collect these airborne fibers. The negative pressure inside a properly installed mini-enclosure helps draw airborne fibers away from the plenum. Asbestos is also released into the air at the floor line when debris lands on the floor (prompt clean up will prevent additional release from the ACM being walked on). The mini-enclosure helps contain these fibers, and the HEPA vacuum used to form a negative pressure will help collect them. Limit the use of Level C work practices to individuals with the proper training and experience.

These work practices are for individual small maintenance activities where the amount of debris involved can be contained in one 60" by 60" disposal bag. It is standard industry practice not to fill these bags more than one-third full, to allow for proper sealing and to guard against breakage. They should not be used for work such as replacing all ceiling panels in a room. The work practices are based on "T-bar" ceilings with lift out panels, but can be easily modified for Z-spline and other sorts of ceilings that provide plenum access.

Maintenance staff employees should be instructed not to remove ceiling tiles below ACM without wearing the proper respiratory protection, clearing the area of other people, and observing asbestos waste disposal procedures. Personnel performing this work should be properly trained and protected.

S1 . Summary ... continued

Examples

The work practices in this section are examples. They should be edited as necessary to suit the requirements of the O&M program for the specific facility.

Level A: Move a non-ACM ceiling panel to make observations above a lay-in ceiling below exposed surfacing ACM in good condition, where a competent person has determined that there is no ACM dust or debris on top of the ceiling tiles.

Level B: Move or replace non-ACM ceiling panels in a lay-in ceiling below exposed surfacing ACM in good or fair condition where there may be dust or debris on top of the ceiling tile.

Level C: Move non-ACM ceiling panels to access plenum area where plenum space contains exposed surfacing or other ACM in poor condition and there is ACM dust and debris present on top of ceiling.

Related Work Practices

- S 2 Attach item to an ACM finished surface that is above a ceiling.
- S 3 Work in ceiling plenum space where exposed surfacing ACM is present.
- S 4 Install wiring in plenum space where exposed surfacing ACM is present.
- M 2 Remove asbestos-containing ceiling panels in lay-in ceiling system.
- M 4 Remove asbestos-containing ceiling tiles in spline ceiling system.

Worker Recommendations

One worker for Levels A and B. Two workers for Level C. A person with air monitoring training might be required. This person can be one of the workers.

S1 . Level A

Moving one non-asbestos-containing ceiling panel below a plenum space that has exposed surfacing ACM

Example

The following are examples of work that can be performed using the procedures of this Level A work practice. If job conditions vary from the examples stop work and notify your supervisor.

- A. Move a non-ACM ceiling panel to make observations above a lay-in ceiling below exposed surfacing ACM in good condition, where a competent person has determined that there is no ACM dust or debris on top of the ceiling tiles.

Notes

The space above the ceiling is a "controlled area." Do not enter this area, or disturb ceiling tiles unless authorized by facility management

Do not enter the space above the ceiling using this work practice unless you know that there is no ACM debris on top of ceiling. If you do not know if there is debris on top of the ceiling then use Level B procedures to open ceiling.

Work Practice

1. Perform Pre-work activities on Level A Worker Checklist.
2. See General Procedure WI for standard tools, equipment and materials list.
3. Place ladder or scaffold in work area.
4. Carefully lift up ceiling panel. If lifting is obstructed by wires, ducts, conduit, etc., move to another panel. Keep panel as flat as possible while lifting panel. Lift panel slightly above grid system and slowly slide panel to one side, leaving panel on top of an adjacent panel.
5. Wet wipe or HEPA vacuum the underside of the panel which was moved. Carefully replace ceiling panel and complete applicable steps on Level A Worker Checklist to complete work.

S1 . Level B

Moving one non-asbestos-containing ceiling panel below a plenum space that has exposed surfacing ACM

Example

The following are examples of work that can be performed using the procedures of this Level B work practice. If job conditions vary from the examples stop work and notify your supervisor.

- A. Move or replace a non-ACM ceiling panel in a lay-in ceiling below exposed surfacing ACM in good or fair condition where there may be a small amount of debris or dust on top of the ceiling tile.

Notes

The space above the ceiling is a "controlled area." Do not enter this area, or disturb ceiling tiles unless you have been authorized by facility management.

Use this work practice where there is debris or dust on top of the ceiling tiles, but the ceiling can be opened using the procedures in this work practice without generating visible dust or debris from material on top of the ceiling.

Do not use this procedure if more than a very small amount of debris will be disturbed. If more than a very small amount of debris is found, stop work, close ceiling and notify your supervisor.

Work Practice

1. Perform Pre-work activities on Level-B Worker Checklist.
2. Tools, equipment and materials:
 - a. Tools as needed from the lists in General Procedure W1
 - b. Tools and materials needed for work on ceiling
 - c. HEPA vacuum with a long enough hose to sit on the floor with the nozzle being used above the ceiling.
3. Prepare work area with drop cloth. See General Procedure W10.
4. Place tools, equipment and materials needed onto drop cloth.
5. Put on respirator and perform fit check.
6. HEPA vacuum around edges of all panels to be removed.
7. While holding nozzle of HEPA vacuum in vicinity slowly lift one edge of center ceiling panel. Immediately HEPA vacuum space at lifted edge. Lift entire panel straight up and HEPA vacuum all four sides.
8. Place panel on top of adjacent ceiling.

S1 . Level B ... continued

9. Note that the operation of the HEPA vacuum is intended to clean the air in the location of the work. As such the nozzle should be kept above the ceiling as much as possible and the canister on the floor.
10. Climb to a position which permits access to the top of the ceiling adjacent to the removed panel.
11. Working in the space above the ceiling, HEPA vacuum both sides of the ceiling panel first removed and hand it down into a 6 mil (0.15 mm) polyethylene bag for storage.
12. Remove loose material hanging from the friable ACM with the suction from the HEPA vacuum.
13. Pass wand of operating HEPA vacuum through air between ACM and top of ceiling.
14. HEPA vacuum the tops of all ceiling panels which are in reach.
15. Carefully HEPA vacuum the crack between the suspension system and ceiling panels from the top for all ceiling panels within reach.
16. Remove ceiling panels as required while constantly HEPA vacuuming all four edges of panel and suspension system.
17. Working in space above ceiling HEPA vacuum both sides on each panel removed and hand each down into a 6 mil (0.15 mm) polyethylene bag.
18. Maintain HEPA vacuum in operation with nozzle above ceiling and exhaust at floor for the entire time that the ceiling is open and work is being done above the ceiling.
19. When above-ceiling work is complete replace ceiling panels.
20. HEPA vacuum worker's head, arm, and shoulders before climbing down from ceiling.
21. HEPA vacuum ladder while climbing down.
22. While standing on plastic sheet thoroughly HEPA vacuum ladder and pass it to person standing off sheet.
23. Complete applicable steps on Level B Worker Checklist.

S1 . Level C

Moving one non-asbestos-containing ceiling panel below a plenum space that has exposed surfacing ACM.

Example

The following are examples of work that can be performed using the procedures of this Level C work practice. If job conditions vary from the examples stop work and notify your supervisor.

- A. Move non-ACM ceiling panels to access plenum area where plenum space contains exposed surfacing or other ACM in poor condition and there is ACM dust or debris present on top of ceiling.

Note:

The space above the ceiling is a "controlled area." Do not enter this area, or disturb ceiling tiles unless authorized by facility management

These procedures involve working in an environment where there could be elevated levels of airborne asbestos. Do not attempt to use this work practice unless you have been trained as an asbestos abatement worker including training in the use of respirators and personal and area decontamination procedures.

Do not use this procedure if more debris will be disturbed than will fit comfortably into one 60" by 60" disposal bag. If more than this amount of debris is found, stop work, close ceiling and notify your supervisor.

Work Practice

1. Perform Pre-work activities on Level C checklist.
2. Tools, equipment and materials:
 - a. Tools as needed from the lists in General Procedure W1
 - b. Tools and materials needed for work on ceiling
3. Complete Worker General Procedure W4 "Secure Work Area"
4. Put down drop sheet and complete Worker General Procedure W10 "Polyethylene Drop Cloth"
5. Erect mini-enclosure and set up negative pressure system and/or HEPA filtered local exhaust ventilation according to General Procedure W20 "Mini-Enclosure"
6. Place tools, equipment and materials needed into enclosure. Include a HEPA vacuum inside enclosure for vacuuming areas above ceiling.
7. Enter enclosure
8. Put on respirator and perform fit test, and put on protective clothing. Enter enclosure.

S1 . Level C ... continued

9. Carefully lift up ceiling panel while HEPA vacuuming around edges of panel. Remove any ACM debris and dust from the top of the ceiling panel or adjacent panels with the HEPA vacuum. Keep panel as flat as possible while lifting panel. Lift panel slightly above grid system and slowly slide panel to one side, leaving panel on top of an adjacent panel. Maintain nozzle of HEPA vacuum in operation above plane of the ceiling at all times that the ceiling is open.
10. Lightly mist plenum space and top side of ceiling where work will occur using garden sprayer with amended water.
11. Pick up any bulk debris on top of ceiling panels where work will occur and place into disposal bags.
12. HEPA vacuum ceiling suspension system and top side of ceiling where work will occur.
13. Wet wipe or HEPA vacuum the underside of the panel which was moved. Carefully replace ceiling panel and perform clean-up and tear-down steps on Level C Worker Checklist to complete work.

S2 . Summary

Attach component to an ACM finished surface above a ceiling.

Summary

This work practice covers the procedures for attaching components to an ACM finished surface (such as a steel beam with a covering of spray-applied fireproofing) that is located above a ceiling.

Examples

The work practices in this section are examples. They should be edited as necessary to to suit the requirements of the O&M program for the specific facility

Level A: A. Mount a "rosettes" with bedding adhesive to the surface of fireproofing above a suspended ceiling. Attach device to "rosettes."

The O&M designer or APM must determine that the adhesion and cohesion of the fireproofing is strong enough to support the load of the device being installed. This work practice is most useful for small light devices such as sensors for a fire alarm or energy management system.

Level B: A. Clamp a bracket onto the flange of a beam that is covered with spray applied asbestos-containing fireproofing.

Related Work Practices

- S1 Moving one non-asbestos-containing ceiling panel below a plenum space that has exposed surfacing ACM.
- S5 Attach component to ceiling finished with ACM.

Worker Recommendations

One worker is usually sufficient for Level A and B. More workers may be needed for Level A and Level B to increase efficiency or for additional health and/or safety considerations. A person with air monitoring training might be required. This person can be a worker.

S2 . Level A

Attach component to an ACM finished surface above a ceiling.

Example

The following is an example of work that can be performed using the procedures of this Level A work practice. If job conditions vary from the examples stop work and notify your supervisor.

- A. Mount a "rosettes" with bedding adhesive to the surface of fireproofing above a suspended ceiling if a competent person determines that the fireproofing will support the load of the device being installed. Attach device to "rosettes."

Notes

The ceiling is a "controlled system." Do not contact or work on ceiling unless authorized by facility management

Work Practice

1. Perform Pre-work activities on Level A checklist.
2. Tools, equipment and materials:
 - a. Tools as needed from the lists in General Procedure W1
3. Complete Worker General Procedure W4 "Secure Work Area"
4. Place tools, equipment and materials needed in work area.
5. Put bedding adhesive on bottom of rosette and press against ceiling.
6. Install device by attaching to rosette.
7. Perform clean-up and tear-down steps on Level A checklist to complete work.

S2. Level B

Attach component to an ACM finished surface above a ceiling.

Example

The following are examples of work that can be performed using the procedures of this Level B work practice. If job conditions vary from the examples stop work and notify your supervisor.

- A. Clamp a bracket onto the flange of a beam that is covered with spray applied asbestos-containing fireproofing.

Notes

A Negative Exposure Assessment must have been made by a Competent Person before this work practice is used. If a negative exposure assessment (NEA) has not been made, stop work and notify your supervisor.

The space above the ceiling is a "controlled area." Do not enter this area, or disturb ceiling tiles unless you have been authorized by facility management. Coordinate work with proper O & M work practice for accessing type of ceiling present in work area. See Work Practices S1, M2, and M4.

Do not spray encapsulant on fireproofing or steel to which fireproofing is to be applied without specific authorization from your supervisor. An inappropriate encapsulant could cause the fireproofing to fail and result in a life threatening situation.

Work Practice

1. Perform Pre-work activities on Level B checklist.
2. Tools, equipment and materials:
 - a. Tools as needed from the lists in General Procedure W1
 - b. Bracket to be clamped to surface
3. Complete General Procedure W4 "Secure Work Area"
4. Prepare work area with drop cloth. See General Procedure W10.
5. Place tools, equipment and materials needed into work area. Include a HEPA vacuum.
6. Obtain access through ceiling using O & M work practice selected (see note above step 1).
7. HEPA vacuum area above ceiling within reach from access hole.
8. Mist surface of fireproofing in location where bracket is to be installed with amended water. DO NOT SATURATE FIREPROOFING.

S2. Level B ... continued

9. Hold bracket against surface of fireproofing and secure by tightening clamp through fireproofing. Use care not to dislodge any fireproofing.
10. Use a HEPA vacuum to remove any fireproofing material that has been loosened by the clamp.
11. Repair any damage to the fireproofing with new fireproofing patching material that is approved by its manufacturer for hand application. Install in accordance with manufacturer's instructions.
12. Carefully install item on bracket without disturbing fireproofing material. Perform maintenance work, repair area with new non-ACM surfacing, and perform clean-up and tear-down steps on Level B checklist to complete work.

S3 . Summary

Remove a small amount of ACM surfacing above a ceiling

Summary

This work practice covers the procedures removing a small amount of asbestos-containing fireproofing structural steel above a ceiling.

Examples

The work practices in this section are examples. They should be edited as necessary to suit the requirements of the O&M program for the specific facility

Level B: A. Remove up to one square foot of fireproofing from structural steel above a ceiling to attach a bracket.

Level C: A. Removing ACM fireproofing from a beam to permit new structural steel reinforcing and bracing to be welded in place to reinforce a floor under a new file room..

Paint usually needs to be removed prior to welding operations. Usually paint on structural steel is lead-based. Lead-based paint O&M work practices will need to be developed for this work and coordinated with the asbestos O&M program. Refer to the NIBS publication "Operation and Maintenance of Lead-Based Paint" for information on setting up an O&M program and for appropriate work practices.

Related Work Practices

S1 Moving one non-asbestos-containing ceiling panel below a plenum space that has exposed surfacing ACM.

S8 Cut hole in surfacing ACM.

Worker Recommendations

One worker is usually sufficient for Level B. Two workers for Level C. More workers may be needed for Level A and Level B to increase efficiency or for additional health and/or safety considerations. A person with air monitoring training might be required. This person can be a worker.

S3. Level B

Remove a small amount of ACM surfacing above a ceiling

Example

The following are examples of work that can be performed using the procedures of this Level B work practice. If job conditions vary from the examples stop work and notify your supervisor.

- A. Remove up to one square foot of fireproofing from structural steel above a ceiling to attach a bracket.

Notes

A Negative Exposure Assessment must have been made by a Competent Person before this work practice is used. If a negative exposure assessment (NEA) has not been made, stop work and notify your supervisor.

The space above the ceiling is a "controlled area." Do not enter this area, or disturb ceiling tiles unless you have been authorized by facility management. Coordinate work with proper O & M work practice for accessing type of ceiling present in work area. See Work Practices S11, M2 or M4.

Do not spray encapsulant on fireproofing or steel to which fireproofing is to be applied without specific authorization from your supervisor. An inappropriate encapsulant could cause the fireproofing to fail and result in a life threatening situation.

Work Practice

1. Perform Pre-work activities on Level B checklist.
2. Tools, equipment and materials:
3. Tools as needed from the lists in General Procedure W1
 - a. Bracket to be attached to beam.
 - b. Scraper 2-3" (50-75 mm) wide stiff blade
 - c. Stiff nylon bristle brushes
 - d. Replacement fireproofing patching material
4. Complete General Procedure W4 "Secure Work Area"
5. Prepare work area with drop cloth. See General Procedure W10.
6. Place tools, equipment and materials needed into work area. Include a HEPA vacuum.
7. Obtain access through ceiling using O & M work practice selected (see note above step 1).
8. HEPA vacuum area above ceiling within reach from access hole.

S3. Level B ... continued

9. Wet fireproofing that is to be removed with amended water. Allow water to soak through fireproofing to substrate. Apply more water as required to saturate fireproofing that is to be removed.
10. Scrape wetted fireproofing from steel. Hold a pan immediately under area being scraped to catch debris. If dry fireproofing is encountered, stop scraping, re-wet and allow water to soak in. Remove all wetted material. Promptly place removed fireproofing in a disposal bag. Spray pan with amended water and wet wipe to remove all fireproofing debris and residue.
11. After fireproofing is removed, wet surface of steel with amended water and wet wipe surface with paper towels. Wet wipe until all residue is removed. After all residue is removed wet wipe surface with clean water without surfactant. Dispose of paper towels as asbestos waste.
12. HEPA vacuum surface of steel and edge of remaining fireproofing.
13. Perform work as necessary to attach bracket to steel.
14. Replace removed fireproofing with new fireproofing patching material. Install fireproofing patch material in accordance with facility's fireproofing repair work practices, and manufacturer's instructions.
15. Carefully install item on bracket without disturbing fireproofing material.
16. Perform clean-up and tear-down steps on Level B checklist to complete work.

S3 . Level C

Remove a small amount of ACM surfacing above a ceiling

Example

The following are examples of work that can be performed using the procedures of this Level C work practice. If job conditions vary from the examples stop work and notify your supervisor.

- A. Removing ACM fireproofing from a beam to permit new structural steel reinforcing and bracing to be welded in place to reinforce a floor under a new file room.

Notes

Do not use this procedure if more material will be removed than will fit comfortably into one 60" by 60" disposal bag. If more than this amount of material is involved, stop work, close ceiling and notify your supervisor.

The space above the ceiling is a "controlled area." Do not enter this area, or disturb ceiling tiles unless authorized by facility management. Coordinate work with proper O & M work practice for accessing type of ceiling present in work area. See **Work Practices S1, M2, or M4.**

These procedures involve working in an environment where there could be elevated levels of airborne asbestos. Do not attempt to use this work practice unless you have been trained as an asbestos abatement worker including training in the use of respirators and personal and area decontamination procedures.

Work Practice

1. Perform Pre-work activities on Level C checklist.
2. Tools, equipment and materials:
 - a. Tools as needed from the lists in General Procedure W1
 - b. Scraper 2-3" (50-75 mm) wide stiff blade
 - c. Stiff nylon bristle brushes
 - d. Maintenance item(s) to be attached to surface
 - e. Replacement fireproofing patching material
3. Complete Worker General Procedure W4 "Secure Work Area"
4. Put down drop sheet and complete Worker General Procedure W10 "Polyethylene Drop Cloth"
5. Erect mini-enclosure and set up negative pressure system and/or HEPA filtered local exhaust ventilation according to General Procedure W20 "Mini-Enclosure"
6. Place tools, equipment and materials needed into enclosure. Include a HEPA vacuum outside of but with hose extending inside enclosure with for vacuuming areas above ceiling.
7. Put on respirator and perform fit test, put on protective clothing

S3 . Level C ... continued

8. Enter enclosure and obtain access through ceiling using appropriate O&M work practice.
9. HEPA vacuum area above ceiling within reach from access hole.
10. Extend mini-enclosure above ceiling, if feasible, using polyethylene sheet and framing taped together to provide enclosure around the work area without contacting ACM covered surface. Vary construction of the extended mini-enclosure depending on the existing construction above the ceiling. Polyethylene and framing may be secured to pipes, conduit, and metal hangers if they are not covered with ACM. If an extended mini-enclosure is not feasible, mist area above ceiling and lay a polyethylene drop cloth below the area where removal is required. If drop cloth cannot be used, suspend polyethylene below immediate work area to catch ACM to be removed. Worker should be located to one side of removal area (inside enclosure) during removal.
11. Wet fireproofing that is to be removed with amended water. Allow water to soak through fireproofing to substrate. Apply more water as required to saturate fireproofing that is to be removed.
12. Scrape wetted fireproofing from steel. Hold a pan immediately under area being scraped to catch debris. If dry fireproofing is encountered, stop scraping, re-wet and allow water to soak in. Remove all wetted material. Promptly place removed fireproofing in a disposal bag. After completing removal of fireproofing spray pan with amended water and wet wipe to remove all fireproofing debris and residue.
13. After fireproofing is removed, wet surface of steel with amended water and wet wipe surface with paper towels. Wet wipe until all residue is removed. After all residue is removed wet wipe surface with clean water without surfactant. Dispose of paper towels as asbestos waste.
14. HEPA vacuum surface of steel and edge of remaining fireproofing.
15. Perform work as necessary to attach bracket to steel.
16. Replace removed fireproofing with new fireproofing patching material. Install fireproofing patch material in accordance with facility's fireproofing repair work practices, and manufacturer's instructions.
17. Remove sufficient materials to permit installation of new structural steel reinforcement and braces. Remove sufficient material, from both sides of beam as necessary, in areas of steel that will be heated sufficiently by the welding to cause delamination of fireproofing.
18. Remove paint on the steel in locations where welding is to occur, or where paint may be overheated or burned during welding. Use paint removal procedures from the facility's Lead Based Paint O&M program, unless you know that paint has been tested and found to be lead-free. If you have not been trained and equipped to remove lead based paint, stop work and notify your supervisor.
19. Install new structural steel.

S3 . Level C... continued

20. If the original steel installations was painted, repaint those areas from which paint has been removed a primer approved for use with the patching fireproofing material.
21. If the replacement fireproofing requires an adhesive, apply a coating of fireproofing manufacturer's adhesive/sealer in accordance with manufacturer's application instructions.
22. Do not spray encapsulant on fireproofing or steel to which fireproofing is to be applied without specific authorization from your supervisor. An inappropriate encapsulant could cause the fireproofing to fail and result in a life threatening situation.
23. Install new fireproofing in areas where fireproofing was removed and on all new steel work. Install fireproofing in thickness as indicated on work order. Follow manufacturer's directions for correct application of fireproofing.
24. Perform clean-up and tear-down steps on Level C checklist to complete work.

S4 . Summary

Work in ceiling plenum space where exposed surfacing ACM is present.

Summary

This work practice covers situations where work must be performed in a ceiling plenum space that has exposed surfacing ACM.

Use of these procedures is limited to a situation where the amount of waste generated is not greater in size than the

OSHA limit on Class III work (operation will generate no more waste than will fit into one 60" by 60" glovebag or disposal bag). It is standard industry practice not to fill these bags more than one-third full, to allow for proper sealing and to guard against breakage.

Examples

Work above a ceiling where there is ACM fireproofing could result in contact with or disturbance of ACM. Maintenance of an HVAC mixing box is used as an example to illustrate the use of these work practices.

Level A: Work above ceilings where there is ACM surfacing material but it is in good condition and can be avoided during the work, and there is no ACM dust or debris on the mixing box. Controls are needed to insure that a disturbance of the ACM does not occur. This can be accomplished by designating the area above the ceiling as a "controlled area," and allowing access to only those who have been given awareness training. The awareness training needs to inform workers of the locations and need to avoid contact with the ACM. Examples of this type of work are:

- A. Replace HVAC mixing box: above ceiling, below asbestos-containing fireproofing in good condition, where there is no ACM dust or debris on the mixing box or any of the systems in the area of the work. The fireproofing is near to the mixing box and may be contacted during the work.
- B. Open or close one valve above ceiling where exposed fireproofing in good condition is present.
- C. Inspect HVAC mixing box below asbestos-containing fireproofing in good condition.

Level B: Work above ceilings where there is ACM surfacing material that is in good condition and can be avoided during the work, but there is some loose ACM debris on top of the mixing box. This debris needs to be removed before the box is worked on. This can be accomplished by picking up the ACM with a HEPA vacuum and then wet wiping the surface. The workers performing this work need to have at least O&M training. A negative exposure assessment has to be made to demonstrate that airborne fiber levels during the work remain below the PELs. The types of work in this category include:

S4 . Summary ... continued

- A. Replace HVAC mixing box: above ceiling, below asbestos-containing fireproofing in good condition. There is dust or debris from surfacing ACM is present on top of box, that is accessible and easily removed.
- B. Install new conduit (attached to existing supports) in plenum space where exposed fireproofing in good condition is present.
- C. Repair leak in non-ACM insulated water line above ceiling where exposed surfacing ACM is present.
- D. Maintain HVAC mixing box below asbestos-containing fireproofing in good condition.

Level C: This example pre-supposes that the situation is more difficult, and the top of the unit is inaccessible so that overspray cannot be removed before the unit is removed. It is assumed that overspray and debris will be dropped as the unit is maneuvered down out of the ceiling. This work practice requires that the wetting of fireproofing overspray. This is fine as this is not part of the fireproofing life safety system. Training as abatement workers is more adequate for those performing Level C work in a mini-enclosure where exposure to elevated asbestos levels and the need for a wet decontamination is possible. This project could probably be accomplished as a Level B task if all surfaces of the mixing box were accessible and all ACM overspray was carefully removed prior to performing the work (after a "remove overspray" work practice that did not exceed the PEL was developed).

Use of this procedure is limited to a situation where the amount of waste generated is not greater in size than the OSHA limit on Class III work (operation will generate no more waste than will fit into one 60" by 60" glovebag or disposal bag).

Frequently, O&M programs will avoid the use of Level C work practices. If Level C work is infrequently encountered, it is best to limit this type of work to outside abatement contractors who are accustomed to working in environments with elevated asbestos levels.

- A. Replace HVAC mixing box above ceiling where the equipment, duct, hangers, and surrounding conduit and piping are covered with loose ACM fireproofing overspray, debris and bounce back. Material on top of mixing box is inaccessible and cannot be removed before box is lowered. Overspray on surrounding systems will be dislodged if not removed before work is performed on the mixing box.

Related Work Practices

- S1 Moving one non-asbestos-containing ceiling panel below a plenum space that has exposed surfacing ACM.
- S2 Attach component to an ACM finished surface that is above a ceiling.
- S4 Install wiring in plenum space where ACM is present.
- M19 Remove HVAC filters in unit serving plenum space with exposed ACM.

S4 . Summary ...continued

Worker Recommendations:

One worker is usually sufficient for Level A and Level B. Two workers for Level C. More workers may be needed to increase efficiency or for additional health and/or safety considerations. A person with air monitoring training might be required. This person can be a worker.

S4 . Level A

Work in ceiling plenum space where exposed surfacing ACM is present.

Example

The following are examples of work that can be performed using the procedures of this Level A work practice. If job conditions vary from the examples stop work and notify your supervisor.

- A. Replace HVAC mixing box: above ceiling, below asbestos-containing fireproofing in good condition, where there is no ACM dust or debris on the mixing box or any of the systems in the area of the work. The fireproofing is near to the mixing box and may be contacted during the work.

Notes

The space above the ceiling is a "controlled area." Do not enter this area, or disturb ceiling tiles unless authorized by facility management

Do not enter the space above the ceiling using this work practice unless you know that there is no ACM debris on top of ceiling. If you do not know if there is debris on top of the ceiling then use S-1 Level B procedures to open ceiling.

Coordinate work with proper O & M work practice for accessing type of ceiling present in work area. See Work Practices S1, M2, or M4

Work Practice

1. Perform Pre-work activities on Level A checklist.
2. Tools, equipment and materials:
 - a. Tools as needed from the lists in General Procedure W1
3. Complete Worker General Procedure W4 "Secure Work Area"
4. Place tools, equipment and materials needed in work area.
5. Obtain access above ceiling using appropriate O & M work practice.
6. Perform maintenance work required.
7. Complete applicable steps on Level A checklist to complete work.

S4 . Level B

Work in ceiling plenum space where exposed surfacing ACM is present.

Example

The following are examples of work that can be performed using the procedures of this Level B work practice. If job conditions vary from the examples stop work and notify your supervisor.

- A. Replace HVAC mixing box: above ceiling, below asbestos-containing fireproofing in good condition. There is a small amount of dust or debris from surfacing ACM is present on top of box, that is accessible and easily removed.

Notes

A Negative Exposure Assessment must have been made by a Competent Person before this work practice is used. If a negative exposure assessment (NEA) has not been made, stop work and notify your supervisor.

The space above the ceiling is a "controlled area." Do not enter this area, or disturb ceiling tiles unless you have been authorized by facility management.

Coordinate work with proper O & M work practice for accessing type of ceiling present in work area. See Work Practices S2, M2, or M4.

Work Practice

1. Perform Pre-work activities on Level B checklist.
2. Tools, equipment and materials:
 - a. Tools as needed from the lists in General Procedure W1
 - b. Maintenance item(s) required to perform work in plenum space.
3. Complete Worker General Procedure W4 "Secure Work Area"
4. Put down drop sheet and complete Worker General Procedure W10 "Polyethylene Drop Cloth"
5. Place tools, equipment and materials needed onto drop cloth
6. Obtain access above ceiling using appropriate O & M work practice.
7. Pick up any bulk debris within reach on top of ceiling and place into disposal bags.
8. Remove debris from top of mixing box with HEPA vacuum. Thoroughly wet wipe surface to remove all residue of ACM.
9. HEPA vacuum top side of ceiling within reach from access area.

S4 . Level B ... continued

10. HEPA vacuum and wet-wipe surfaces that will be contacted or item to be maintained or repaired.
11. Perform maintenance work required and clean-up and tear-down steps on Level 2 checklist to complete work.

S4 . Level C

Work in ceiling plenum space where exposed surfacing ACM is present.

Example

The following are examples of work that can be performed using the procedures of this Level C work practice. If job conditions vary from the examples stop work and notify your supervisor.

- A. Replace HVAC mixing box above ceiling where the equipment, duct, hangers, and surrounding conduit and piping are covered with loose ACM fireproofing overspray, debris and bounce back. Material on top of mixing box is inaccessible and cannot be removed before box is lowered. Overspray on surrounding systems will be dislodged if not removed before work is performed on the mixing box.

Notes

The space above the ceiling is a "controlled area." Do not enter this area, or disturb ceiling tiles unless authorized by facility management

These procedures involve working in an environment where there could be elevated levels of airborne asbestos. Do not attempt to use this work practice unless you have been trained as an asbestos abatement worker including training in the use of respirators and personal and area decontamination procedures.

Do not use this procedure if more debris will be disturbed than will fit comfortably into one 60" by 60" disposal bag. If more than this amount of debris is found, stop work, close ceiling and notify your supervisor.

Coordinate work with proper O & M work practice for accessing type of ceiling present in work area. See Work Practices S1, M2, or M4.

Work Practice

1. Perform Pre-work activities on Level C checklist.
2. Tools, equipment and materials:
 - a. Tools as needed from the lists in General Procedure W1
 - b. Maintenance item(s) required to perform work in plenum space.
3. Complete Worker General Procedure W4 "Secure Work Area"
4. Put down drop sheet and complete Worker General Procedure W10 "Polyethylene Drop Cloth"
5. Erect mini-enclosure and set up negative pressure system and/or HEPA filtered local exhaust ventilation according to General Procedure W20 "Mini-Enclosure"

S4 . Level C ... continued

6. Place tools, equipment and materials needed into enclosure. Include a HEPA vacuum located outside of this inclosure with hose and nozzle extended inside enclosure for vacuuming areas above ceiling.
7. Put on respirator and perform fit test, put on protective clothing
8. Enter enclosure and obtain access through ceiling using appropriate O&M work practice.
9. HEPA vacuum top side of ceiling within reach from access area, and HEPA vacuum and wet-wipe item to be repaired or replaced.
10. Extend mini-enclosure above ceiling, if feasible, using polyethylene sheet and framing taped together to provide enclosure around the work area without contacting ACM covered surface. Vary construction of the extended mini-enclosure depending on the existing construction above the ceiling. Polyethylene and framing may be secured to pipes, conduit, and metal hangers if they are not covered with ACM. If an extended mini-enclosure is not feasible, mist area above ceiling and lay a polyethylene drop cloth below the area where work will occur. If drop cloth cannot be used, suspend polyethylene below immediate work area to catch ACM that may fall.
11. Remove accessible overspray on mixing box, duct work, hangers, conduit, etc. that may be disturbed by the work. Remove overspray by dampening with amended water and collecting with the nozzle of the HEPA vacuum where possible. In locations that the material cannot be collected directly with the HEPA vacuum, wet thoroughly with amended water and manually collect into an asbestos disposal bag. After bulk overspray is removed, wet newly exposed areas and use scraper and nylon brush to remove remaining visible residual ACM. Thoroughly wet wipe surface to remove all residue of ACM. Allow surfaces to dry and spray with an asbestos lock-back encapsulant.
12. Remove sufficient materials to permit installation of new hangers. Adequately wet area of surfacing to be removed using garden sprayer containing amended water and allow water to soak in for several minutes. Wet removal area frequently during removal of bulk material and residual material. Using scraper with HEPA vacuum within several inches of removal area, scrape off ACM to at least 3" (75 mm) beyond area where item will be attached. When bulk material is removed, wet newly exposed areas and use scraper and nylon brush to remove remaining visible residual ACM. Place removed ACM into disposal bags. Thoroughly wet wipe exposed surface to remove all residue of ACM.
13. Perform maintenance work required.
14. Replace removed fireproofing with new fireproofing patching material. Install fireproofing patch material in accordance with facility's fireproofing repair work practices, and manufacturer's instructions.
15. Perform clean-up and tear-down steps on Level C checklist to complete work.

S5 . Summary

Install wiring in plenum space where exposed surfacing ACM is present

Summary

This work practice covers situations where wiring and/or conduit are being installed in a ceiling plenum space that has exposed surfacing ACM. The procedures assume that the ACM will not intentionally be disturbed during the work.

Routinely, the installation of computer and telephone cables is done without removing enough ceiling tile. Consequently, the cable is dragged long distances on top of the ceiling, rattling the ceiling. This vibration shakes the ceiling's hanging system, and may vibrate the fireproofing overhead. Depending upon the extent of overspray that is has coated the hangers, and how well it bonded, a worker can shake this oversprayed fireproofing loose, without ever touching the material, simply by causing the ceiling to vibrate. If the surface upon which the fireproofing is sprayed is "bouncy" this vibration can disturb the fireproofing itself.

Use of these procedures is limited to situation where the amount of waste generated is not greater in size than the OSHA limit on Class III work (operation will generate no more waste than will fit into one 60" by 60" glovebag or disposal bag.

Level A: work practices should only be used in situations where the ACM surface material is in good condition and well out of reach of the work, and there is no ACM dust and/or debris on top of ceiling tiles. During design of the O&M procedure, a Competent Person (as defined by OSHA) must make a determination that the

exposed surfacing ACM is in good condition and that there is no dust or debris on top of the ceiling tiles that could cause an exposure to a worker that is above the PEL.

Level A work practices should be used only in situations where access through the ceiling is frequent enough that the condition of any ACM in the space is known, and it is known that: there is no debris on the ceiling, the fireproofing is out of reach of the work, and that the vibration of the ceiling during cable installation will not dislodge oversprayed fireproofing from hanger or disturb the fireproofing. If access through the space is infrequent or it cannot be known with confidence that there is no debris on top of the ceiling tile, or the vibration of the ceiling during cable installation may disturb overspray of fireproofing, then Level B procedures should be used.

Level B: work practices should be used if there is dust or debris from the ACM surfacing treatment or other ACM material on top of the ceiling tiles or if the ACM surfacing material is close enough to the work that it could be disturbed. If there is considerable ACM debris on top of the ceiling tiles or the ACM surfacing material is near enough to the work that it is inevitably going to be disturbed and abraded by the cable installation in a manner that could release asbestos fibers or visible dust and debris into the air, then an enclosure is needed and Level C procedures should be used. Limit the use of Level C work practices to outside abatement contractors unless these procedures will be used on a routine basis.

S5 . Summary ... continued

Level B work practices should be used where there is some debris on top of the ceiling tiles, but the debris can be removed using the procedures in this work practice without generating airborne asbestos levels above the OSHA PEL, and without releasing visible dust or debris from material on top of the ceiling tiles. Level B work practices should be used if access through the ceiling is infrequent enough that it cannot be known with confidence that there is no debris on top of the ceiling tiles

Use of this procedure is limited to a situation where the amount of waste generated is not greater in size than the OSHA limit on Class III work (operation will generate no more waste than will fit into one 60" by 60" glovebag or disposal bag.

Level C: Training as abatement workers is more adequate for those performing Level C work in a mini-enclosure where exposure to elevated asbestos levels and the need for a wet decontamination is possible. Level C work practices should be used where ACM will be disturbed by the cable installation, there is debris on top of the ceiling tiles, and it is problematic whether Level B procedures will be able to prevent the generation of airborne asbestos levels above the OSHA PEL, or prevent the spread of visible debris and/or dust. Frequently, O&M programs will avoid the use of Level C work practices. If Level C work is infrequently encountered, it is best to limit this type of work to outside abatement contractors who are accustomed to working in environments with elevated asbestos levels.

Examples

Level A: During design of the O&M procedure, a Competent Person (as defined by OSHA) must make a determination that the exposed surfacing ACM is in good condition and that there is no dust or debris on top of the ceiling tiles that could cause an exposure to a worker that is above the PEL.

- A. Installing new plenum rated computer or telephone cables that will lay on top of ceiling, where the ACM surface material is in good condition and well out of reach of the work, and there is no ACM dust and/or debris on top of ceiling tiles

Level B: A. Installing new plenum rated computer or telephone cables that will lay on top of ceiling, where there is a small amount of dust or debris from ACM surfacing treatment or other ACM material on top of the ceiling tiles or if the ACM surfacing material is close enough to the work that it could be disturbed.

Level C: A. Installing new plenum rated computer or telephone cables that will lay on top of ceiling, where there is considerable ACM debris on top of the ceiling tiles or the ACM surfacing material is near enough to the work that it is inevitably going to be disturbed and abraded by the cable installation in a manner that could release asbestos fibers or visible dust and debris into the air.

S5 . Summary ... continued

Related Work Practices

- S1** Moving one non-asbestos-containing ceiling panel below a plenum space that has exposed surfacing ACM.
- S2** Attach component to an ACM finished surface that is above a ceiling.
- S3** Work in ceiling plenum space where exposed surfacing ACM is present.

Worker Recommendations

One worker for Level A and Level B. Two workers may facilitate pulling wires between two locations; Two workers for Level C. A person with air monitoring training might be required. This person can be one of the workers.

S5 . Level A

Install wiring in plenum space where exposed surfacing ACM is present.

Example

The following are examples of work that can be performed using the procedures of this Level A work practice. If job conditions vary from the examples stop work and notify your supervisor.

- A. Installing new plenum rated computer or telephone cables that will lay on top of ceiling, where the ACM surface material is in good condition and well out of reach of the work, and there is no ACM dust and/or debris on top of ceiling tiles.

Notes

The space above the ceiling is a "controlled area." Do not enter this area, or disturb ceiling tiles unless authorized by facility management

Coordinate work with proper O & M work practice for accessing type of ceiling present in work area. See Work Practices S1, M2, or M4.

Work Practice

1. Perform Pre-work activities on Level A checklist.
2. Tools, equipment and materials:
 - a. Tools as needed from the lists in General Procedure W1
 - b. Wiring and related tools
3. Complete Worker General Procedure W4 "Secure Work Area"
4. Place tools, equipment and materials needed in work area.
5. Obtain access through ceiling using appropriate O & M work practice.
6. Observe top of ceiling in direction that cables are to be run. Determine conditions at the next location where access above the ceiling is required to determine the level of work practice required for entry. If there is any ACM debris or dust on top of ceiling tiles use level B work procedures, and locate the next ceiling access so that all parts of the ceiling top can be cleaned.
7. Open enough ceiling tiles that the cables can be passed by hand from opening to opening.
8. Install cable(s) by passing leading end of cable(s) from opening to opening. **DO NOT TOSS CABLES OR ANY OTHER OBJECT ABOVE THE CEILING.**
9. Run wiring as required. Do not contact exposed ACM surfacing and minimize disturbance of ceiling system and other components above ceiling while running wiring.
10. Perform clean-up and tear-down steps on Level A checklist to complete work.

S5 . Level B

Install wiring in plenum space where exposed surfacing ACM is present.

Example

The following are examples of work that can be performed using the procedures of this Level B work practice. If job conditions vary from the examples stop work and notify your supervisor.

- A. Installing new plenum rated computer or telephone cables that will lay on top of ceiling, where there is a small amount of dust or debris from ACM surfacing treatment or other ACM material on top of the ceiling tiles or if the ACM surfacing material is close enough to the work that it could be disturbed.

Notes

A Negative Exposure Assessment must have been made by a Competent Person before this work practice is used. If a negative exposure assessment (NEA) has not been made, stop work and notify your supervisor.

The space above the ceiling is a "controlled area." Do not enter this area, or disturb ceiling tiles unless you have been authorized by facility management.

Coordinate work with proper O & M work practice for accessing type of ceiling present in work area. See Work Practices S1, M2, or M4.

Work Practice

1. Perform Pre-work activities on Level B checklist.
2. Tools, equipment and materials:
 - a. Tools as needed from the lists in General Procedure W1
 - b. Wiring and related tools
3. Complete Worker General Procedure W4 "Secure Work Area"
4. Prepare work area with drop cloth. See General Procedure W10 "Polyethylene Drop Cloth" Set up multiple work areas if needed.
5. Install a continuous drop cloth under area where cabling is to be run. Secure continuous drop cloth in place to minimize slipping hazards.
6. Install a second drop cloth at each ceiling opening on top of the continuous drop cloth. Secure drop cloths in place to minimize slipping hazards.
7. Place tools, equipment and materials needed onto drop cloth.
8. Obtain access through ceiling using appropriate O & M work practice.
9. HEPA vacuum top side of ceiling within reach from access area.
10. Observe top of ceiling in direction that cables are to be run. Determine conditions at the next location where access above the ceiling is required to determine the level of

S5 . Level B ... continued

work practice required for entry. If there is any ACM debris or dust on top of ceiling tiles use level B work procedures, and locate the next ceiling access so that all parts of the ceiling top can be cleaned.

11. Remove any ACM debris in the path to be followed by cables. If there is any ACM debris remove with a HEPA vacuum. Spray a lock back encapsulant on ceiling tile tops wherever debris is removed.
12. Open enough ceiling tiles that the cables can be passed by hand from opening to opening.
13. Install cable(s) by passing leading end of cable(s) from opening to opening. **DO NOT TOSS CABLES OR ANY OTHER OBJECT ABOVE THE CEILING.**
14. Run wiring as required by passing the cable from opening to opening. Do not drag cable across ceiling. Do not drag cables from floor up into ceiling plenum. Do not contact exposed ACM surfacing above ceiling. Minimize disturbance of ceiling system and other components above ceiling while running wiring.
15. Perform clean-up and tear-down steps on Level B checklist to complete work.

S5 . Level C

Install wiring in plenum space where exposed surfacing ACM is present.

Example

The following are examples of work that can be performed using the procedures of this Level C work practice. If job conditions vary from the examples stop work and notify your supervisor.

- A. Installing new plenum rated computer or telephone cables that will lay on top of ceiling, where there is considerable ACM debris on top of the ceiling tiles or the ACM surfacing material is near enough to the work that it is inevitably going to be disturbed and abraded by the cable installation in a manner that could release asbestos fibers or visible dust and debris into the air.

Notes

The space above the ceiling is a "controlled area." Do not enter this area, or disturb ceiling tiles unless authorized by facility management

These procedures involve working in an environment where there could be elevated levels of airborne asbestos. Do not attempt to use this work practice unless you have been trained as an asbestos abatement worker including training in the use of respirators and personal and area decontamination procedures.

Do not use this procedure if more debris will be disturbed than will fit comfortably into one 60" by 60" disposal bag. If more than this amount of debris is found, stop work, close ceiling and notify your supervisor.

Coordinate this work with proper O & M work practice for accessing type of ceiling present in work area. See Work Practices S1, M2, or M4.

Work Practice

1. Perform Pre-work activities on Level C checklist.
2. Tools, equipment and materials:
 - a. Tools as needed from the lists in General Procedure W1
 - b. Wiring and related tools
3. Complete Worker General Procedure W4 "Secure Work Area"
4. Put down drop sheet and complete Worker General Procedure W10 "Polyethylene Drop Cloth"
5. Erect mini-enclosure and set up negative pressure system and/or HEPA filtered local exhaust ventilation according to General Procedure W20 "Mini-Enclosure." Set up multiple enclosures if needed.

S5 . Level C ... continued

6. Place tools, equipment and materials needed into enclosure. Include a HEPA vacuum outside of the enclosure with the hose and nozzle extending inside enclosure for vacuuming areas above ceiling.
7. Enter enclosure and obtain access through ceiling using appropriate O & M work practice.
8. HEPA vacuum top side of ceiling within reach from access hole.
9. Observe top of ceiling in direction that cables are to be run. Determine conditions at the next location where access above the ceiling is required to determine the level of work practice required for entry. If there is any ACM debris or dust on top of ceiling tiles use level B work procedures as a minimum. If the ACM fireproofing is likely to be disturbed during cable installation then use Level C procedures. Locate the next ceiling access so that and disturbance of ACM fireproofing occurs in a mini-enclosure and so that all parts of the ceiling top can be cleaned.
10. Prior to installation of cable past ACM: Mist any fireproofing that is to be disturbed with amended water, and install a drop cloth at ceiling level to catch debris from fireproofing. During cable installation hold the HEPA vacuum nozzle under the point of disturbance, if possible. Wet wipe cable after it is run past ACM. Run complete length of cable needed and coil on other side of ACM. Saturate any debris on drop cloth with amended water and mist the air between the ACM and the drop cloth. Fold drop cloth with debris inside and place in an asbestos disposal bag. Clean up any other debris and place in an asbestos disposal bag.
11. Remove any ACM debris in the path to be followed by cables. If there is any ACM debris remove with a HEPA vacuum. Spray a lock back encapsulant on ceiling tile tops wherever debris is removed.
12. Perform clean-up and tear-down steps on Level C checklist to complete work.

S6 . Summary

Attach item to ceiling finished with ACM

Summary

This work practice describes the work required to attach an item to a ceiling finished with surfacing ACM, such as acoustical plaster or a decorative sprayed-on surface texture material.

When selecting work practices for a surfacing material it may be necessary to distinguish between situations where the material is in its original condition and those where it has been encapsulated or coated with layers of paint. Different

work practices may be necessary for each situation. This should be clearly described in each work practice.

Use of this procedure is limited to situation where the amount of waste generated is not greater in size than the OSHA limit on Class III work (operation will generate no more waste than will fit into one 60" by 60" glovebag or disposal bag).

Examples

Level A: A. Mount a "rosettes" with bedding adhesive to the surface of a suspended acoustical plaster ceiling. Attach device to "rosettes."

Level B: OSHA requires that during Class III (O&M) operations that involve, "drilling, cutting, abrading, sanding, chipping, breaking, or sawing of thermal system insulation or surfacing materials, the employer shall use impermeable dropcloths, and shall isolate the operation using mini-enclosures or glove bag systems ...or another isolation method." This work practice relies on the HEPA exhausted collar on the drill as, "another isolation method." During design of the O&M program the designer must be a competent person and must determine that the use of the HEPA exhausted collar as described in the work practice effectively isolates the drilling work. This evaluation should be based on an, "Initial exposure assessment," leading to a "Negative Exposure Assessment," (NEA) as described in the OSHA construction standard 29 CFR 1926.1101(f)(2). During implementation of the program, the APM must also be a competent person, and must make a determination that conditions at a specific job site are equivalent to those existing during development of the work practice, so that the work practice is applicable. The work order issued to the person performing the work should inform them of the NEA and any conditions that are attached to the NEA. It is possible that after there has been some experience with the OSHA regulation the manufacturers of the type of equipment used in this work practice will make the proper evaluations and submissions to OSHA and provide a copy of this to the O&M program designer. In any case as a minimum requirement the supervisor that assigns work to maintenance staff should be a competent person able to evaluate the applicability of a dust collection collar with HEPA vacuum to a particular situation.

A. Attach a battery-powered smoke detector to a suspended acoustical plaster ceiling with two toggle bolts.

S6 . Summary ... continued

- B. Attach track lighting to an ACM finished ceiling where experience has proven a minimal disturbance will occur.

- Level C:**
- A. Remove a small amount of acoustical plaster using a glove box or frame mounted glovebag, to permit the installation of a junction box.
 - B. Install smoke detector in suspended acoustical plaster ceiling by cutting a 2" X 4" hole and installing a junction box.
 - C. Attach track lighting system to ACM finished ceiling.
 - D. Install exposed conduit, junction boxes and light fixtures to ACM finished ceiling.
 - E. Attach new folding door to acoustical plaster where structural modifications are not needed for support.
-

Related Work Practices

- S1 Move one non-asbestos-containing ceiling panel below a plenum space that has exposed surfacing ACM.
 - S2 Attach component to an ACM finished surface that is above a ceiling.
 - S8 Cut or drill hole in Surfacing ACM.
 - S9 Replace bulbs in light fixture attached to or in surface finished with ACM.
-

Worker Recommendations

One worker for Level B Two workers for Level C More workers may be needed for certain Level C tasks. A person with air monitoring training might be required. This person can be one of the workers.

S6 . Level A

Attach item to ceiling finished with ACM

Example

The following is an example of work that can be performed using the procedures of this Level A work practice. If job conditions vary from the examples stop work and notify your supervisor.

- A. Mount a "rosettes" with bedding adhesive to the surface of an acoustical plaster ceiling. Attach device to "rosettes."
-

Notes

The ceiling is a "controlled system." Do not contact or work on ceiling unless authorized by facility management

Work Practice

1. Perform Pre-work activities on Level A checklist.
2. Tools, equipment and materials:
 - a. Tools as needed from the lists in General Procedure W1
3. Complete Worker General Procedure W4 "Secure Work Area"
4. Place tools, equipment and materials needed in work area.
5. Put bedding adhesive on bottom of rosette and press against ceiling.
6. Perform clean-up and tear-down steps on Level A checklist to complete work.

S6 . Level B

Attach item to ceiling finished with ACM

Example

The following are examples of work that can be performed using the procedures of this Level B work practice. If job conditions vary from the examples stop work and notify your supervisor.

- A. Attach a battery-powered smoke detector to a suspended acoustical plaster ceiling with two toggle bolts.
 - B. Attach track lighting to an ACM finished surface where experience has proven a minimal disturbance will occur.
-

Notes

The ceiling is a "controlled system." Do not contact or work on ceiling unless authorized by facility management

A Negative Exposure Assessment must have been made by a Competent Person before this work practice is used. If a negative exposure assessment (NEA) has not been made, stop work and notify your supervisor.

Work Practice

1. Perform Pre-work activities on Level B checklist.
2. Tools, equipment and materials:
 - a. Tools as needed from the lists in General Procedure W1
 - b. Item to be attached to ceiling and related tools
3. Complete Worker General Procedure W4 "Secure Work Area"
4. Put down drop sheet and complete Worker General Procedure W10 "Polyethylene Drop Cloth"
5. Place tools, equipment and materials needed onto drop cloth.
6. Wet area on ceiling where item will be attached using garden sprayer with amended water.
7. Drill holes through ceiling with one of the following procedures:
 - a. Drill hole with drill equipped with dust collection collar attached to a HEPA vacuum. Maintain HEPA vacuum in operation during entire process of drilling holes.
 - b. Using hand tools and HEPA vacuum near attachment location, or power tools with attached HEPA vacuum, attach item to ceiling. If small holes are being drilled, drill through a wet sponge or shaving cream to control fiber release.
 - c. Scrape away surfacing to at least ½" [13 mm] beyond where hole is needed. Keep the hose of an operating HEPA vacuum within 6" [150mm] and below area where scraping is occurring. Adequately wet scraping area and any dust or debris generated. Drill hole through substrate after ACM is removed.

S6 . Level B ... continued

8. Immediately place all debris into ACM disposal bags.
9. Spray holes with a clear penetrating encapsulant to stabilize disturbed edges.
10. Perform clean-up and tear-down steps on Level B checklist to complete work.

S6 . Level C

Attach item to ceiling finished with ACM

Example

The following are examples of work that can be performed using the procedures of this Level C work practice. If job conditions vary from the examples stop work and notify your supervisor.

- A. Remove a small amount of acoustical plaster using a glove box or frame mounted glovebag, to permit the installation of a junction box.
 - B. Install smoke detector in suspended acoustical plaster ceiling by cutting a 2" X 4" hole and installing a junction box.
 - C. Attach track lighting system to ACM finished ceiling.
 - D. Install exposed conduit, junction boxes and light fixtures to ACM finished ceiling.
 - E. Attach new folding door to acoustical plaster where structural modifications are not needed for support.
-

Notes

The ceiling is a "controlled system." Do not contact or disturb ceiling unless authorized by facility management

Do not use power tools inside glovebags.

These procedures involve working in an environment where there could be elevated levels of airborne asbestos. Do not attempt to use this work practice unless you have been trained as an asbestos abatement worker including training in the use of respirators and personal and area decontamination procedures.

Do not use this procedure if more debris will be disturbed than will fit comfortably into one 60" by 60" disposal bag. If more than this amount of debris is found, stop work, close ceiling and notify your supervisor.

Work Practice (Frame supported Glovebag)

1. Perform Pre-work activities on Level C checklist.
2. Tools, equipment and materials:
 - a. Tools as needed from the lists in General Procedure W1
 - b. Item to be attached to ceiling and related tools
 - c. Glovebags
 - d. Frame to support glovebag or glove box
3. Complete Worker General Procedure W4 "Secure Work Area"
4. Put down drop sheet and complete Worker General Procedure W10 "Polyethylene Drop Cloth"
5. Set-up frame supported glovebag using Worker General Procedure W18 "Glovebag Removal." Place tools, equipment and materials needed into glovebag.
6. Thoroughly wet material to be removed with amended water.

S6 . Level C ... continued

7. Using a small scraper remove acoustical plaster from scratch coat to a point $\frac{1}{2}$ " back from opening required for junction box.
8. After acoustical plaster is removed wet surface of scratch coat and remove all residue with a stiff nylon brush. After all visible residue has been removed, remove $\frac{1}{16}$ " from surface of scratch coat
9. Spray scratch coat and edges of acoustical plaster with clear penetrating encapsulant.
10. Perform clean-up and tear-down steps on Level C checklist, leave drop cloth in place.
11. Mark location for junction box installation. Drill starter holes in opposite corners.
12. Cut through scratch coat and wire lath between starter holes with pneumatic shear, or heavy tin snips. Keep scratch coat dampened with amended water during cutting.
13. Install old-work junction box.
14. Dispose of all non-asbestos waste as normal construction debris, do not place in asbestos disposal bag.
15. Clean any debris from drop cloth. Fold drop cloth toward center and dispose of as normal construction debris, do not place in asbestos disposal bag.

S6 . Level C ... continued

Work Practice (mini-enclosure)

1. Perform Pre-work activities on Level C checklist.
2. Tools, equipment and materials:
 - a. Tools as needed from the lists in General Procedure W1
 - b. Item to be attached to ceiling and related tools
3. Complete Worker General Procedure W4 "Secure Work Area"
4. Put down drop sheet and complete Worker General Procedure W10 "Polyethylene Drop Cloth"
5. Erect mini-enclosure and set up negative pressure system and/or HEPA filtered local exhaust ventilation according to General Procedure W20 "Mini-Enclosure"
6. Place tools, equipment and materials needed into enclosure. Include a HEPA vacuum outside enclosure with hose and nozzle extending inside enclosure for vacuuming areas above ceiling.
7. Enter enclosure and wet area on ceiling where item will be attached using garden sprayer with amended water. Allow amended water to sink in. Add additional water until area to be removed is saturated.
8. Using a small scraper remove acoustical plaster from scratch coat to a point 1/2" back from opening required for junction box. Hold a pan immediately under area to catch debris while scraping.
9. After acoustical plaster is removed wet surface of scratch coat and remove all residue with a stiff nylon brush. After all visible residue has been removed, remove 1/16" from surface of scratch coat
10. Spray scratch coat and edges of acoustical plaster with clear penetrating encapsulant.
11. Mark location for junction box installation. Drill starter holes in opposite corners with drill equipped with dust collection collar attached to an operating HEPA vacuum.
12. Cut through scratch coat and wire lath between starter holes with pneumatic shear, or heavy tin snips. Keep scratch coat dampened with amended water during cutting.
13. Install old-work junction box.
14. Immediately put all asbestos and non-asbestos waste and debris in an asbestos disposal bag.
15. Perform clean-up and tear-down steps on Level C checklist to complete work.

S7 . Summary

Repair or replace item in surface finished with ACM

Summary

This work practice covers the procedures for repairing or replacing an item that is installed in or attached to a surface finished with ACM, such as an acoustical plaster ceiling or fireproofed deck or beam.

Examples

Level A: This example pre-supposes that the construction of the light fixture permits the diffuser to be removed without touching or disturbing the ceiling. Workers performing this task should at a minimum have awareness training so that they are informed of the asbestos-containing ceiling, and know to avoid disturbing it. During design of the O&M procedure, the designer (who must be a Competent Person as defined by OSHA) must make a determination that the surfacing ACM is in good condition and that it will not be disturbed by the work.

- A. Replace diffuser that is completely surrounded by the metal frame of a light fixture recessed in a ceiling finished with ACM acoustical plaster, where the diffuser can be removed without any disturbance of ACM.

Level B: This example pre-supposes that the light fixture is constructed so that is clamped in a hole in the ceiling and can be removed by taking out a few screws and sliding the entire unit out. Workers performing this task should at a minimum have O&M training and sufficient electrical knowledge to be able to disconnect the light fixture.

- A. Removal of a light fixture that is recessed in a ceiling finished with ACM acoustical plaster, where the light fixture has an escutcheon so that it can be unfastened and dropped out.

Level C: This example pre-supposes that the light fixture is constructed so it is an integral part of the ceiling construction and has to be cut out of the ceiling. The mini-enclosure in this instance is a miniature asbestos abatement work area. Workers performing this task should at a minimum have O&M training and preferably abatement worker training. This sort of work is better left to an outside abatement contractor unless facility personnel routinely perform abatement work.

- A. Removal of a light fixture that is recessed in a ceiling finished with ACM acoustical plaster, where the fixture frame is integral with the ceiling and plaster must be removed and cut to free the fixture.

S7 . Summary ... continued

Related Work Practices

- S1 Moving one non-asbestos-containing ceiling panel below a plenum space that has exposed surfacing ACM.
- S5 Attach item to ceiling finished with ACM.
- S8 Cut or drill hole in Surfacing ACM.
- S9 Replace bulbs in light fixture attached to or in surface finished with ACM.
- S11 Repair damaged surfacing ACM.

Worker Recommendations

One worker is usually sufficient for Level A and Level B. Two workers for Level C. More workers may be needed to increase efficiency or for additional health and/or safety considerations. A person with air monitoring training might be required. This person can be a worker.

S7 . Level A

Repair or replace item in surface finished with ACM

Example

The following are examples of work that can be performed using the procedures of this Level A work practice. If job conditions vary from the examples stop work and notify your supervisor.

- A. Replace diffuser that is completely surrounded by the metal frame of a light fixture recessed in a ceiling finished with ACM acoustical plaster, where the diffuser can be removed without any disturbance of ACM.

Notes

The ceiling is a "controlled system." Do not contact or disturb ceiling unless authorized by facility management

Work Practice

1. Perform Pre-work activities on Level A checklist.
2. Tools, equipment and materials:
 - a. Tools as needed from the lists in General Procedure W1
 - b. Repair and/or replacement parts and tools as needed.
3. Complete Worker General Procedure W4 "Secure Work Area"
4. Place tools, equipment and materials needed in work area.
5. Carefully open diffuser without touching the ACM acoustical plaster ceiling. Unhook diffuser from light fixture and remove. Do not touch ACM or rattle light fixture.
6. Perform clean-up and tear-down steps on Level A checklist to complete work.

S7 . Level B

Repair or replace item in surface finished with ACM

Example

The following are examples of work that can be performed using the procedures of this Level B work practice. If job conditions vary from the examples stop work and notify your supervisor.

- A. Removal of a light fixture that is recessed in a ceiling finished with ACM acoustical plaster, where the light fixture has an escutcheon so that it can be unfastened and dropped out.

Notes

A Negative Exposure Assessment must have been made by a Competent Person before this work practice is used. If a negative exposure assessment (NEA) has not been made, stop work and notify your supervisor.

The ceiling is a "controlled system." Do not contact or disturb ceiling unless you have been authorized by facility management.

Work Practice

1. Perform Pre-work activities on Level B checklist.
2. Tools, equipment and materials:
 - a. Tools as needed from the lists in General Procedure W1
 - b. Repair and/or replacement parts and tools as needed
3. Complete Worker General Procedure W4 "Secure Work Area"
4. Put down drop sheet and complete Worker General Procedure W10 "Polyethylene Drop Cloth"
5. Place tools, equipment and materials needed in work area or on drop cloth.
6. Lightly mist area of ACM acoustical plaster around frame of light fixture using garden sprayer containing amended distilled water and allow water to soak in for several minutes.
7. Completely remove screws holding light fixture in place, while holding fixture so that it does not move.
8. Gradually lower one side of fixture while removing any loose ceiling material with a HEPA vacuum. Lower other side while continuing with HEPA vacuum. Use HEPA vacuum to remove any ceiling material as fixture is lowered from the ceiling. Disconnect wire from fixture and coil above ceiling so that it does not contact the acoustical plaster.

S7 . Level B ... continued

9. HEPA vacuum and then wet wipe all surfaces of light fixture.
10. Collect any surfacing debris from repair/replacement work using HEPA vacuum.
11. Perform clean-up and tear-down steps on Level B checklist to complete work.

S7 . Level C

Repair or replace item in surface finished with ACM

Example

The following are examples of work that can be performed using the procedures of this Level C work practice. If job conditions vary from the examples stop work and notify your supervisor.

- A. Removal of a light fixture that is recessed in a ceiling finished with ACM acoustical plaster, where the fixture frame is integral with the ceiling and plaster must be removed and cut to free the fixture.

Notes

The ceiling is a "controlled system." Do not contact or disturb ceiling unless authorized by facility management

These procedures involve working in an environment where there could be elevated levels of airborne asbestos. Do not attempt to use this work practice unless you have been trained as an asbestos abatement worker including training in the use of respirators and personal and area decontamination procedures.

Do not use this procedure if more debris will be disturbed than will fit comfortably into one 60" by 60" disposal bag. If more than this amount of debris is found, stop work, close ceiling and notify your supervisor.

Work Practice

1. Perform Pre-work activities on Level C checklist.
2. Tools, equipment and materials:
 - a. Tools as needed from the lists in General Procedure W1
 - b. Repair and/or replacement parts and tools as needed
3. Complete Worker General Procedure W4 "Secure Work Area"
4. Put down drop sheet and complete Worker General Procedure W10 "Polyethylene Drop Cloth"
5. Erect mini-enclosure and set up negative pressure system and/or HEPA filtered local exhaust ventilation according to General Procedure W20 "Mini-Enclosure"
6. Place tools, equipment and materials needed into enclosure. Include a HEPA vacuum outside of enclosure with hose and nozzle extending inside enclosure for use during the work.
7. Enter enclosure and wet area of surfacing within 6" [150 mm] of light fixture using garden sprayer containing amended water and allow water to soak in for several minutes. Apply additional water as necessary until acoustical plaster is saturated in area adjacent to light fixture.

S7 . Level C ... continued

8. Using a small scraper, carefully remove wetted ACM acoustical finish down to scratch coat for 2" on all sides of light fixture. Hold a pan immediately under scraping area to catch debris. At frequent intervals place ACM debris in asbestos disposal bag and spray with amended water.
9. After all acoustical plaster is removed, wet scratch coat and remove any residue with a stiff nylon brush. Hold pan under brushing area to catch any debris. After all visible residue is removed, wet surface and scrape off 1/16" of scratch coat into pan. Frequently empty pan into asbestos disposal bag.
10. Drill a starter hole at each corner of fixture using a drill equipped with a dust collection collar attached to an operating HEPA vacuum.
11. Use a pneumatic shear or large tin snips to cut through scratch coat and wire lath on all sides of light fixture.
12. Drop down light fixture, disconnect electrical and coil above ceiling. Wrap cut edged on light fixture with duct tape. Double bag in asbestos disposal bag and dispose of as asbestos waste.
13. Collect any surfacing debris from repair/replacement work using HEPA vacuum.
14. Perform clean-up and tear-down steps on Level C checklist to complete work.

S8 . Summary

Cut or drill hole in surfacing ACM

Summary

This work practice covers the work required to cut or drill a hole through surfacing ACM, such as acoustical plaster or fireproofing. If possible, ACM should be removed before holes are drilled. If holes are drilled in an ACM wall surface with a cavity behind the wall, labels or record keeping information should note that ACM might be present in the cavity.

Examples

Level B: A. Drill a hole through asbestos-containing decorative texture finish.

Level C: A. Drill or cut hole for pipe or duct chase using tools with or without HEPA filtered dust collection in an enclosure.
B. Install few new conduits through fireproofed metal deck.

Related Work Practices

- S1 Move one non-asbestos-containing ceiling panel below a plenum space that has exposed surfacing ACM.
- S2 Attach component to an ACM finished surface that is above a ceiling.
- S6 Attach item to ceiling finished with ACM.
- S7 Repair or replace item in surface finished with ACM.

Worker Recommendations

One worker is usually sufficient for Level B. Two workers for Level C. More workers may be needed to increase efficiency or for additional health and/or safety considerations. A person with air monitoring training might be required. This person can be a worker.

S8 . Level B

Cut or drill hole in surfacing ACM

Example

The following are examples of work that can be performed using the procedures of this Level B work practice. If job conditions vary from the examples stop work and notify your supervisor.

- A. Drill a hole through a substrate after removing an asbestos-containing decorative texture finish.
-

Notes

A Negative Exposure Assessment must have been made by a Competent Person before this work practice is used. If a negative exposure assessment (NEA) has not been made, stop work and notify your supervisor.

The ceiling is a "controlled system." Do not contact or disturb ceiling unless you have been authorized by facility management.

Work Practice

1. Perform Pre-work activities on Level B checklist.
2. Tools, equipment and materials:
 - a. Tools as needed from the lists in General Procedure W1
 - b. Scraper (if used)
3. Complete Worker General Procedure W4 "Secure Work Area"
4. Put down drop sheet and complete Worker General Procedure W10 "Polyethylene Drop Cloth"
5. Place tools, equipment and materials needed onto drop cloth. If access above ceiling is required, obtain access using appropriate O & M work practice.
6. Install polyethylene sheet below location of work to catch any falling debris.
7. Drill a hole through a substrate after removing an asbestos-containing decorative texture finish using the following procedures:
 - a. Adequately wet area where hole is to be drilled. Wet sufficiently so that ACM is wetted completely. Allow amended water to soak into material so that ACM is wetted through to substrate in spot where ACM is to be removed.
 - i. If the surface is coated with paint, mist surface and scarify paint sufficiently for ACM to be wetted. Remove paint by peeling or scraping off as necessary. Wet surface of exposed ACM. Allow amended water to soak into material so that ACM is wetted through to substrate in spot where ACM is to be removed.
 - b. Remove ACM surfacing material using one of the following procedures.
 - i. Scrape away surfacing material to at least ½" [13 mm] beyond where hole is needed. Hold a pan immediately under area to catch debris while scraping. If any dry ACM is encountered stop scraping and wet ACM. Maintain scraping area and any dust or debris generated wet at all times.
 - ii. Scrape away surfacing material to at least ½" [13 mm] beyond where hole is needed. Scrape material directly into the nozzle of an operating HEPA

S8 . Level B ... continued

vacuum or use nozzle of HEPA vacuum directly as tool to remove ACM. Continuously maintain HEPA vacuum nozzle within 6" [150mm] of where work is occurring. If any dry ACM is encountered stop scraping and wet ACM. Maintain scraping area and any dust or debris generated wet at all times.

- c. After acoustical plaster is removed wet surface of substrate and remove all residue with a stiff nylon brush. Remove water and residue from surface with paper towels. Immediately dispose of towels in an asbestos waste bag. Repeat brushing and paper towel process three (3) times. If substrate is a scratch coat, wet substrate and scrape off 1/16" of scratch coat to remove any residual ACM that may be trapped in the texture of the scratch coat.
 - d. Spray substrate and edges of acoustical plaster with clear penetrating encapsulant.
 - e. Drill hole through substrate after ACM is removed.
 - f. If hole is being drilled through a surface, such as acoustical plaster, where back side is inaccessible, place HEPA vacuum hose near or through hole and run for several minutes to clean air on backside of surface.
8. If hole is being drilled through a surface, such as a suspended ceiling, where back side is inaccessible, place HEPA vacuum hose near or through hole and run for several minutes to collect any airborne dust air on backside of surface.
 9. If hole is drilled from top side of deck, adequately wet ACM on underside and install polyethylene sheet or enclosure below ACM on underside that will catch any falling debris, including material from hole (such as a concrete cylinder). Drill hole through surface. Adequately wet drilling area while drilling. Wet any debris on drop cloth or in enclosure on underside, package up debris and drop cloth/enclosure and dispose of as ACM.
 10. Perform clean-up and tear-down steps on Level B checklist to complete work.

S8 . Level C

Cut or drill hole in surfacing ACM

Example

The following are examples of work that can be performed using the procedures of this Level C work practice. If job conditions vary from the examples stop work and notify your supervisor.

- A. Drill or cut hole for pipe or duct chase using tools with or without HEPA filtered dust collection in an enclosure.
 - B. Install a few new conduits through fireproofed metal deck.
-

Notes

The ceiling is a "controlled system." Do not contact or disturb ceiling unless authorized by facility management

These procedures involve working in an environment where there could be elevated levels of airborne asbestos. Do not attempt to use this work practice unless you have been trained as an asbestos abatement worker including training in the use of respirators and personal and area decontamination procedures.

Do not use this procedure if more debris will be disturbed than will fit comfortably into one 60" by 60" disposal bag. If more than this amount of debris is found, stop work, close ceiling and notify your supervisor.

Work Practice

1. Perform Pre-work activities on Level C checklist.
2. Tools, equipment and materials:
 - a. Tools as needed from the lists in General Procedure W1
 - b. Scraper
 - c. Hand or power drill or saw with HEPA vacuum attachment.
3. Complete Worker General Procedure W4 "Secure Work Area"
4. Put down drop sheet and complete Worker General Procedure W10 "Polyethylene Drop Cloth"
5. Erect mini-enclosure and set up negative pressure system and/or HEPA filtered local exhaust ventilation according to General Procedure W20 "Mini-Enclosure"
6. Place tools, equipment and materials needed into enclosure. Include a HEPA vacuum inside enclosure for use during the work. IF access above a ceiling is required, obtain access using the appropriate O & M work practice. If surface to be drilled is above a ceiling, extend enclosure (if feasible) to within approximately 1/2" [13 mm] of surfacing ACM.

S8 . Level C ... continued

Cut Hole through a Wall

1. Inside of mini-enclosure, install polyethylene sheet below removal location to catch any falling debris.
2. Adequately wet area where hole is to be cut.
3. Remove ACM from entire area of hole and to at least ½" [13 mm] beyond where hole is needed. Keep the hose of an operating HEPA vacuum within 6" [150 mm] of where scraping is occurring. Adequately wet, any dust or debris generated. Cut hole through scraped area after ACM is removed.
4. Drill small holes using a drill with dust collection collar attached to a HEPA vacuum. Maintain HEPA vacuum in operation during entire process of drilling holes.

Core Drill Through Deck:

1. Install mini-enclosure on top of deck. Set up core drill inside mini-enclosure
2. Install drop cloth and local enclosure (such as a frame supported glove-bag) on underside of deck.
3. Arrange pan to support local enclosure, use pan large enough to contain falling water and debris if sheet plastic of local enclosure tears. Support pan to accommodate weight of water and debris including concrete cylinder cored out of deck.
4. Wet ACM on underside of deck with amended water.
5. Core drill hole through Deck. Wet drilling area during operation so that site of drilling is continuously wet.
6. After hole is complete, remove core drill and wash down hole to remove any residue of fireproofing.
7. Fill enclosure with sufficient absorbent to soak up any loose water.
8. Fold up local enclosure with debris and place in asbestos disposal bag.
9. Wet wipe interior of pan.
10. If hole is drilled from underside of deck, install mini-enclosure below deck, and install local enclosure on floor above.

Clean-up and Teardown:

1. Let HEPA vacuum run for at least 15 minutes to clean air in enclosure.
2. Perform maintenance work and clean-up and tear-down steps on Level C checklist to complete work.

S9 . Summary

Replace bulbs in light fixture attached to or in surface finished with ACM

Summary

This work practice covers procedures for replacing light bulbs in a fixture attached to a surface finished with ACM. Light fixtures attached to or in surfaces finished with ACM can cause damage to ACM if the fixtures are moved during maintenance work. In instances where the ACM will be neither contacted or disturbed a work practice level is not assigned, but sufficient control must be exercised to insure that the material is not inadvertently disturbed. This can be accomplished by designating the ACM surfacing material as a "Controlled System" which may be contacted only by authorized personnel. Awareness training is required for workers who could contact the material. OSHA (29 CFR 1926.11-1(k)(8)(vii)) (Clarified by the Compliance Directive CPL 2-2.63 page C-36) requires that the ACM or PACM be labeled. A practical way of doing this that will insure that workers see the warning is to put a label at each latch point for the light fixture.

When selecting work practices for a surfacing material it may be necessary to distinguish between situations where the material is in its original condition and those where it has been encapsulated or coated with layers of paint. Different work practices may be necessary for each situation. This should be clearly described in each work practice.

Level A: The work is Level A, if the material is going to be contacted during the work, but not disturbed. The OSHA regulation (29 CFR 1926.1101) requires that this determination be made by a competent person. Refer to Appendix I for more information on the OSHA regulation.

Level B: Some acoustic materials are very fragile so that a small amount of debris may be released due to contact, or there may be ACM debris inside or on top of a light fixture. Replacing bulbs in these situations is Level B work.

Examples

- Level A:**
- A. Replace bulbs in recessed or pendant mount light fixtures attached to an asbestos-containing decorative texture finish or acoustical plaster ceiling where the material may be contacted, but it is unlikely that any debris will be released.
 - B. Replace bulbs in fixtures mounted on fireproofed surface where the material may be contacted, but it is unlikely that any material will be released.

Level B: This work practice is appropriate for situations where the surfacing treatments may be disturbed during re-lamping knocking off a small amount of debris, or will be contacted and is so fragile that the contact may knock off a small amount of debris. If the release of debris is unlikely, then Level A procedure could be used. The ceiling should be designated as a "controlled system" that is to be contacted only by those with at a minimum awareness training.

S9 . Summary ... continued

- A. Replace bulbs in light fixtures recessed in an asbestos-containing decorative texture finish or acoustical plaster ceiling where the material is likely to be contacted and release of a small amount of debris is likely.
 - B. Replace bulbs in recessed fixtures where ACM surfacing material debris is visible inside fixture.
 - C. Replace bulbs in pendant mount fixture where ACM debris is present inside or on top of fixture.
-

Related Work Practices

- S5 Attach item to ceiling finished with ACM.
 - S11 Repair damaged surfacing ACM.
-

Worker Recommendations

One worker is usually sufficient. Two or more workers may be needed to increase efficiency or for additional health and/or safety considerations. A person with air monitoring training might be required. This person can be a worker.

S9 . Level A

Replace bulbs in light fixture attached to or in surface finished with ACM

Example

The following are examples of work that can be performed using the procedures of this Level A work practice. If job conditions vary from the examples stop work and notify your supervisor.

- A. Replace bulbs in recessed or pendant mount light fixtures attached to an asbestos-containing decorative texture finish or acoustical plaster ceiling where the material may be contacted, but it is unlikely that any debris will be released.
- B. Replace bulbs in fixtures mounted on fireproofed surface where the material may be contacted, but it is unlikely that any material will be released.

Notes

A Negative Exposure Assessment must have been made by a Competent Person before this work practice is used. If a negative exposure assessment (NEA) has not been made, stop work and notify your supervisor.

The ceiling is a "controlled system." Do not contact or disturb ceiling unless you have been authorized by facility management.

Work Practice

1. Perform Pre-work activities on Level A checklist.
2. Tools, equipment and materials:
 - a. Tools as needed from the lists in General Procedure W1
 - b. Replacement bulbs
3. Complete Worker General Procedure W4 "Secure Work Area"
4. Place tools, equipment and materials needed in work area.
5. Carefully replace light bulbs without jarring fixture or releasing debris. Clean-up any dust or debris generated using HEPA vacuum. Use Work Practice M22 if HEPA vacuum needs maintenance, or if bag or filter needs to be replaced.
6. Perform clean-up and tear-down steps on Level A checklist to complete work.

S9 . Level B

Replace bulbs in light fixture attached to or in surface finished with ACM

Example

The following are examples of work that can be performed using the procedures of this Level B work practice. If job conditions vary from the examples stop work and notify your supervisor.

- A. Replace bulbs in light fixtures recessed in an asbestos-containing decorative texture finish or acoustical plaster ceiling where the material is likely to be contacted and release of a small amount of debris is likely.
- B. Replace bulbs in fixtures mounted on fireproofed surface where the material is likely to be contacted and release of a small amount of debris is likely.

Notes

A Negative Exposure Assessment must have been made by a Competent Person before this work practice is used. If a negative exposure assessment (NEA) has not been made, stop work and notify your supervisor.

The ceiling is a "controlled system." Do not contact or disturb ceiling unless you have been authorized by facility management.

Work Practice

1. Perform Pre-work activities on Level B checklist.
2. Tools, equipment and materials:
 - a. Tools as needed from the lists in General Procedure W1
 - b. Replacement bulbs
3. Complete Worker General Procedure W4 "Secure Work Area"
4. Put down drop sheet and complete Worker General Procedure W10 "Polyethylene Drop Cloth"
5. Place tools, equipment and materials needed onto drop cloth.
6. Put on respirator and perform fit check.
7. Carefully replace light bulbs without jarring fixture. Clean-up any dust or debris generated using HEPA vacuum. Use Work Practice M22 if HEPA vacuum needs maintenance, or if bag or filter needs to be replaced
8. Perform clean-up and tear-down steps on Level B checklist to complete work.

S10 . Summary

Clean room with exposed surfaces finished with ACM

Summary

This work practice covers the procedures for cleaning a room with exposed surfaces finished with ACM. This room has been predetermined to not be contaminated or has previously been cleaned. However, debris could be released from the material by contact with occupants during normal occupation of the space. This work practice is intended to collect any debris that may have been released before it can accumulate. This is **not** the procedure to use if a fiber release has occurred. See related work practices below.

When selecting work practices for a surfacing material it may be necessary to distinguish between situations where the material is in its original condition and those where it has been encapsulated or coated with layers of paint. Different work practices may be necessary for each situation. This should be clearly described in each work practice.

Examples

- Level A**
- A. Routine cleaning in room with spray-applied acoustical plaster on walls or ceilings where there is no visible dust or debris.
 - B. Routine cleaning in mechanical room with exposed fireproofing in good condition where there is no visible dust or debris.

Related Work Practices

- S11** - Repair damaged surfacing ACM.
- T6** - Repair damaged thermal system insulation on a pipe.
- R7** - Clean resilient asbestos flooring.
- M20** - Clean up debris from minor fiber release.

Worker Recommendations

One worker.

S10 . Level A

Clean room with exposed surfaces finished with ACM

Example

The following is an example of work that can be performed using the procedures of this Level A work practice. If job conditions vary from the examples stop work and notify your supervisor.

- A. Routine cleaning in room with spray applied acoustical plaster on walls or ceilings where there is no visible debris.
- B. Routine cleaning in mechanical room with exposed fireproofing in good condition where there is no visible debris.

Notes

If any debris from ACM is found in an area to be cleaned, notify the APM or your supervisor. The APM will need to determine whether this work practice is appropriate or if more stringent practices are needed.

Work Practice

1. Tools, equipment and materials:
 - a. Standard cleaning equipment and materials
2. Clean area using standard cleaning methods. Avoid contact with any ACM materials that could be damaged during cleaning.
3. Do not clean up asbestos debris. If asbestos debris is found in a space, stop cleaning work in that space and notify your supervisor.
4. The following precautions should be observed when working around the ACM:
 - a. Do not bump ACM with vacuum cleaners, broom handles, mop handles or similar objects. Do not exhaust vacuum cleaners toward ACM.
 - b. Do not brush ACM surfaces with a broom or similar objects to remove cobwebs or other items attached to ACM.

S11 . Summary

Repair damaged surfacing ACM

Summary

This work practice covers the procedures for repairing small amounts of damaged surfacing ACM, such as acoustical plaster or fireproofing. The procedure assumes that the damage is in isolated areas not greater in size than the OSHA limit on Class III work (operation will generate no

more waste than can be contained in one 60" by 60" glovebag or disposal bag). It is standard industry practice not to fill these bags more than one-third full, to allow for proper sealing and to guard against breakage.

Examples

- Level A:** A. Repair small hole in acoustical plaster ceiling or wall without disturbing surrounding plaster.
B. Repair small gouged area in asbestos-containing decorative texture finish without disturbing surrounding finish.

- Level B:** A. Repair gouge marks in acoustical plaster ceiling where a small amount of damaged ACM is present.
B. Repair small area of delaminated acoustical plaster in good condition.

- Level C:** A. Install fire rated enclosure over small area of damaged fireproofing.
B. Trowel-on fireproofing to repair small water damaged area.
C. Repair a small area of delaminated plaster in fair condition.

Related Work Practices

- S2** - Attach component to an ACM finished surface that is above a ceiling.
S6 - Attach item to ceiling finished with ACM.

Worker Recommendations

One worker is usually sufficient for Level A and Level B. Two workers for Level C. More workers may be needed to increase efficiency or for additional health and/or safety considerations. A person with air monitoring training might be required. This person can be a worker.

S11 . Level A

Repair damaged surfacing ACM

Example

The following are examples of work that can be performed using the procedures of this Level A work practice. If job conditions vary from the examples stop work and notify your supervisor.

- A. Repair small hole in acoustical plaster ceiling or wall without disturbing surrounding plaster.
- B. Repair small gouged area in asbestos-containing decorative texture finish without disturbing surrounding finish.

Notes

A Negative Exposure Assessment must have been made by a Competent Person before this work practice is used. If a negative exposure assessment (NEA) has not been made, stop work and notify your supervisor.

The ceiling is a "controlled system." Do not contact or disturb ceiling unless you have been authorized by facility management.

Work Practice

1. Perform Pre-work activities on Level A checklist.
2. Tools, equipment and materials:
 - a. Tools as needed from the lists in General Procedure W1
 - b. Non-ACM caulking materials & tools
3. Complete Worker General Procedure W4 "Secure Work Area"
4. Place tools, equipment and materials needed in work area.
5. Repair damaged area using non-ACM caulking without disturbing ACM. Do not scrape or sand existing ceiling.
6. Perform clean-up and tear-down steps on Level A checklist to complete work.

S11 . Level B

Repair damaged surfacing ACM

Example

The following are examples of work that can be performed using the procedures of this Level B work practice. If job conditions vary from the examples stop work and notify your supervisor.

- A. Repair gouge marks in acoustical plaster ceiling where a small amount of damaged ACM is present.
- B. Repair small area of delaminated acoustical plaster in good condition.

Notes

A Negative Exposure Assessment must have been made by a Competent Person before this work practice is used. If a negative exposure assessment (NEA) has not been made, stop work and notify your supervisor.

The ceiling is a "controlled system." Do not contact or disturb ceiling unless you have been authorized by facility management.

Work Practice

1. Perform Pre-work activities on Level B checklist.
2. Tools, equipment and materials:
 - a. Tools as needed from the lists in General Procedure W1
 - b. Small stiff-bladed scraper
 - c. Non-ACM repair materials & tools
3. Complete Worker General Procedure W4 "Secure Work Area"
4. Put down drop sheet and complete Worker General Procedure W10 "Polyethylene Drop Cloth"
5. Place tools, equipment and materials needed onto drop cloth.
6. Mist any damaged surfacing using garden sprayer containing amended water and allow water to soak in for several minutes.
7. With HEPA vacuum within several inches of damaged area, remove any loose material by hand or with scraper. Collect material in disposal bags as it is removed. Remove material around edges of damaged area until well-adhered material is found, but do not remove beyond area protected by drop cloth. Mist removal area during removal of damaged material.
8. Repair damaged area using non-ACM and perform clean-up and tear-down steps on Level B checklist to complete work.

S11 . Level C

Repair damaged surfacing ACM

Example

The following are examples of work that can be performed using the procedures of this Level C work practice. If job conditions vary from the examples stop work and notify your supervisor.

- A. Install fire rated enclosure over small area of damaged fireproofing.
- B. Trowel-on fireproofing to repair small water damaged area.
- C. Repair a small area of delaminated plaster in fair condition.

Notes

The ceiling is a "controlled system." Do not contact or disturb ceiling unless authorized by facility management.

These procedures involve working in an environment where there could be elevated levels of airborne asbestos. Do not attempt to use this work practice unless you have been trained as an asbestos abatement worker including training in the use of respirators and personal and area decontamination procedures.

Do not use this procedure if more debris will be disturbed than will fit comfortably into one 60" by 60" disposal bag. If more than this amount of debris is found, stop work, close ceiling and notify your supervisor.

Work Practice

1. Perform Pre-work activities on Level C checklist.
2. Tools, equipment and materials:
 - a. Tools as needed from the lists in General Procedure W1
 - b. Small stiff-bladed scraper
 - c. Non-ACM repair materials & tools
3. Complete Worker General Procedure W4 "Secure Work Area"
4. Put down drop sheet and complete Worker General Procedure W10 "Polyethylene Drop Cloth"
5. Erect mini-enclosure and set up negative pressure system and/or HEPA filtered local exhaust ventilation according to General Procedure W20 "Mini-Enclosure"
6. Place tools, equipment and materials needed into enclosure. Include a HEPA vacuum outside of the enclosure with hose and nozzle extending inside enclosure for use during repair work. If access above ceiling is required, obtain access using appropriate O&M work practice.
7. Adequately wet area of damaged surfacing using garden sprayer containing amended water and allow water to soak in for several minutes.

S11 . Level C ... continued

8. With HEPA vacuum within several inches of damaged area, remove any loose material by hand or with scraper. Collect material in disposal bags as it is removed. Remove material around edges of damaged area until well-adhered material is found, but do not remove beyond area protected inside enclosure. Mist removal area during removal of damaged material.
9. Repair damaged area using non-ACM materials.
10. Perform clean-up and tear-down steps on Level C checklist to complete work.

S12 . Summary

Accessing through an ACM finished surface

Summary

This work practice covers the procedures for opening access doors (such as those used in a wall or ceiling to access valves or dampers) in ACM finished surfaces such as acoustical plaster or fireproofing.

When selecting work practices for a surfacing material it may be necessary to distinguish between situations where the material is in its original condition and those where it has been encapsulated or coated with layers of paint. Different work practices may be necessary for each situation. This should be clearly described in each work practice.

Level A work practices should only be used in situations where the ACM surface material is in good condition and will be contacted but not disturbed by the work. During design of the O&M procedure, a Competent Person (as defined by OSHA) must make a determination that the exposed surfacing ACM is in good condition and that contact with the material without disturbance will not cause an exposure to a worker that is above the PEL.

Level B should be used for work that can be accomplished without generating airborne fiber levels in the breathing zone of workers that are above the PEL, and without spreading visible dust and debris from the ACM.

Level C work practices should be used where airborne fiber levels may exceed the PEL, or ACM dust and debris may be spread. In general, developing asbestos control procedures used during the work to the extent that Level B controls can reliably control airborne fiber levels and the spread of ACM dust and debris will result in a safer and more economical O&M program. The procedure assumes that the damage is in isolated areas not greater in size than the OSHA limit on Class III work (operation will generate no more waste than will fit into one 60" by 60" glovebag or disposal bag. Limit the use of Level C work practices to outside abatement contractors unless these procedures will be used on a routine basis.

Examples

Level A: Level A work practices should be used only in situations where the access door can be opened without disturbing the ACM. During design of the O&M procedure, a Competent Person (as defined by OSHA) must make a determination that the ACM will not be disturbed and that there will be no exposure to a worker that is above the PEL.

- A. Open access door in acoustical plaster ceiling that has been opened before. Ceiling or wall is in good condition and debris is not likely on door.

Level B: These procedure use amended water to wet the surface. Some surfaces can be stained by even a small amount of water. An inconspicuous part of the surfacing material should be tested for staining and the work practice adjusted as required to avoid defacing architectural finishes.

S12 . Summary ... continued

- A. Open access door in acoustical plaster ceiling where ACM is in fair condition and may be disturbed.
- B. Open access door that has surfacing material on flanges that will be disturbed when door is opened.

Level C: A. Open access door in acoustical plaster or fireproofed surface where ACM is in poor condition or a significant amount of ACM debris may be present on back side of door.

Related Work Practices

- S6 Attach item to ceiling finished with ACM.
- S7 Repair or replace item in surface finished with ACM.
- S8 Cut or drill hole in Surfacing ACM.

Worker Recommendations

One worker for Level A work. One or two workers for Level B depending upon safety and efficiency considerations. Two workers for Level C. A person with air monitoring training might be required. This person can be a worker.

M12 . Level B...continued

11. If hinges are to be re-used, remove from door following procedures used for closer.
If hinges are to be disposed of, leave hinges attached to door.
12. Wrap door for disposal.
13. Perform clean-up and tear-down steps on Level B checklist to complete work.

S12 . Level A

Accessing through an ACM finished surface

Example

The following is an example of work that can be performed using the procedures of this Level A work practice. If job conditions vary from the examples stop work and notify your supervisor.

- A. Open access door in acoustical plaster ceiling or wall that has been opened before. Ceiling or wall is in good condition and access door can be opened without disturbing ACM.

Notes

A Negative Exposure Assessment must have been made by a Competent Person before this work practice is used. If a negative exposure assessment (NEA) has not been made, stop work and notify your supervisor.

The ceiling is a "controlled system." Do not contact or disturb ceiling unless you have been authorized by facility management.

Work Practice

1. Perform Pre-work activities on Level B checklist.
2. Tools, equipment and materials:
 - a. Tools as needed from the lists in General Procedure W1
3. Complete Worker General Procedure W4 "Secure Work Area"
4. Put down drop sheet and complete Worker General Procedure W10 "Polyethylene Drop Cloth"
5. Place tools, equipment and materials needed in work area.
6. Unlatch door and open carefully. Avoid contact with ACM, be careful not to disturb ACM during process of opening access door.
7. Perform maintenance work required above or behind access door and slowly close door until it is secured in place.
8. Complete applicable steps on Level A checklist to complete work.

S12 . Level B

Accessing through an ACM finished surface

Example

The following are examples of work that can be performed using the procedures of this Level B work practice. If job conditions vary from the examples stop work and notify your supervisor.

- A. Open access door in acoustical plaster ceiling where ACM is in fair condition and may be disturbed.
-

Notes

A Negative Exposure Assessment must have been made by a Competent Person before this work practice is used. If a negative exposure assessment (NEA) has not been made, stop work and notify your supervisor.

The ceiling is a "controlled system." Do not contact or disturb ceiling unless you have been authorized by facility management.

Work Practice

1. Perform Pre-work activities on Level B checklist.
2. Tools, equipment and materials:
 - a. Tools as needed from the lists in General Procedure W1
 - b. Sponge
3. Complete Worker General Procedure W4 "Secure Work Area"
4. Put down drop sheet and complete Worker General Procedure W10 "Polyethylene Drop Cloth"
5. Prepare work area with drop cloth. See General Procedure W10.
6. Place tools, equipment and materials needed onto drop cloth.
7. Unlatch door and open door 1/4" to 1/2" [6mm to 13mm]. HEPA vacuum around edges of door. Slowly open door and HEPA vacuum any debris on door or any ACM disturbed while opening door.
8. Perform maintenance work required above or behind access door and then slowly close door until it is secured in place.
9. Perform clean-up and tear-down steps on Level B checklist to complete work.

S12 . Level C

Accessing through an ACM finished surface

Example

The following are examples of work that can be performed using the procedures of this Level C work practice. If job conditions vary from the examples stop work and notify your supervisor.

- A. Open access door that has surfacing material on flanges that will be disturbed when door is opened.
 - B. Open access door in acoustical plaster or fireproofed surface where ACM is in poor condition or ACM debris may be present on back side of door.
-

Notes

The ceiling is a "controlled system." Do not contact or disturb ceiling unless authorized by facility management

These procedures involve working in an environment where there could be elevated levels of airborne asbestos. Do not attempt to use this work practice unless you have been trained as an asbestos abatement worker including training in the use of respirators and personal and area decontamination procedures.

Do not use this procedure if more debris will be disturbed than will fit comfortably into one 60" by 60" disposal bag. If more than this amount of debris is found, stop work, close ceiling and notify your supervisor.

Work Practice

1. Perform Pre-work activities on Level C checklist.
2. Tools, equipment and materials:
 - a. Tools as needed from the lists in General Procedure W1
 - b. Small stiff-bladed scraper
3. Complete Worker General Procedure W4 "Secure Work Area"
4. Put down drop sheet and complete Worker General Procedure W10 "Polyethylene Drop Cloth"
5. Erect mini-enclosure and set up negative pressure system and/or HEPA filtered local exhaust ventilation according to General Procedure W20 "Mini-Enclosure"
6. Place tools, equipment and materials needed into enclosure. Include a HEPA vacuum outside of enclosure with hose and nozzle extending inside enclosure for vacuuming areas above ceiling.
7. Enter enclosure and remove any ACM surfacing material that may be disturbed when the access door is opened. Remove enough material so that future use of the access door will not involve a disturbance of ACM.
8. Wet any ACM on access door flanges that may be disturbed when door is opened. Wet sufficiently so that ACM is wetted completely. Allow amended water to soak

S12 . Level C ... continued

into material so that ACM is wetted through to substrate in spot where ACM it to be removed.

9. If the surface is coated with paint, mist surface and scarify paint sufficiently for ACM to be wetted. Remove paint by peeling or scraping off as necessary. Wet surface of exposed ACM. Allow amended water to soak into material so that ACM is wetted through to substrate in spot where ACM it to be removed.
10. Remove ACM surfacing material using one of the following procedures.
 - a. Scrape away surfacing material that will disturbed when access door is opened. Hold a pan immediately under area to catch debris while scraping. If any dry ACM is encountered stop scraping and wet ACM. Maintain scraping area and any dust or debris generated wet at all times.
 - b. Scrape away surfacing material that will be disturbed with access door is opened. Scrape material directly into the nozzle of an operating HEPA vacuum or use nozzle of HEPA vacuum directly as tool to remove ACM. Continuously maintain HEPA vacuum nozzle within 6" [150mm] of where work is occurring. If any dry ACM is encountered stop scraping and wet ACM. Maintain scraping area and any dust or debris generated wet at all times.
11. After ACM surfacing is removed wet surface of substrate and remove all residue with a stiff nylon brush. Remove water and residue from surface with paper towels. Immediately dispose of towels in an asbestos waste bag. Repeat brushing and paper towel process three (3) times. If substrate is a scratch coat, wet substrate and scrape off 1/16" of scratch coat to remove any residual ACM that may be trapped in the texture of the scratch coat.
12. Spray substrate and edges of acoustical plaster with clear penetrating encapsulant.
13. Perform maintenance work required above or behind access door.
14. Perform clean-up and tear-down steps on Level C checklist to complete work.

S13 . Summary

Painting surfacing ACM.

Summary

This work practice describes the work required to paint small amounts of surfacing ACM, such as acoustical plaster or a decorative texture finish. Paint coats should be as thin as possible to prevent delamination of surfacing that may be caused by painting. This work may need to be treated as abatement work depending upon the type and condition of the surfacing. When selecting work practices for a surfacing material it may be necessary to distinguish between situations where the material is in its original condition and those where it has been encapsulated or coated with layers of paint. Different work practices may be necessary for each situation. This should be clearly described in each work practice.

Painting a previously painted surface is Level A work because the surfacing material is contacted but not disturbed. The individuals performing this work should at a minimum have O&M training. Painting an unpainted surface where the OSHA PEL will not be exceeded or where the surface is strong enough that dust or debris will not be released is Level B work. If the work will result in airborne fiber levels above the PEL or if dust and/or debris will be released the work is Level C.

Depending upon the type, condition and friability of the ACM, this work may need to be treated as an abatement activity instead of O & M work.

Examples

- Level A:** A. Repaint previously painted asbestos-containing acoustical plaster in good condition. No preparation of the surface is required.
- Level B:** A. Paint asbestos-containing decorative texture finish that has not been previously painted.
- Level C:** A. Paint asbestos-containing acoustical plaster that has not been previously painted.
B. Paint asbestos-containing fireproofing.

Related Work Practices

S11 Repair damaged surfacing ACM.

Worker Recommendations

One worker for Level A and Level B. Two workers for Level C. A person with air monitoring training might be required. This person can be the worker.

S13 . Level A

Painting surfacing ACM.

Example

The following are examples of work that can be performed using the procedures of this Level A work practice. If job conditions vary from the examples stop work and notify your supervisor.

- A. Repaint previously painted asbestos-containing acoustical plaster in good condition. No preparation of the surface is required.

Notes

The ceiling is a "controlled system." Do not contact or disturb ceiling unless authorized by facility management

Use Work Practice M22 if HEPA vacuum needs maintenance, or if bag or filter needs to be replaced.

Work Practice

1. Perform Pre-work activities on Level A checklist.
2. Tools, equipment and materials:
 - a. Tools as needed from the lists in General Procedure W1.
 - b. Paint, rollers or low pressure airless sprayer, and other painting equipment.
3. Complete Worker General Procedure W4 "Secure Work Area"
4. Prepare work area with drop cloth. See General Procedure W10.
5. Place tools, equipment and materials needed on drop cloth.
6. Paint ceiling using sprayer or rollers. If rollers are used, try to contact each area of the ceiling only once to avoid damage to ACM.
7. When painting is completed, clean up any loose debris using wet wiping and/or HEPA vacuuming, and roll up drop cloth. Dispose of paint rollers as ACM.
8. Perform clean-up and tear-down steps on Level A checklist to complete work.

S13 . Level B

Painting surfacing ACM.

Example

The following is an example of work that can be performed using the procedures of this Level B work practice. If job conditions vary from the examples stop work and notify your supervisor.

- A. Paint asbestos-containing decorative texture finish that has not been previously painted.
-

Notes

A Negative Exposure Assessment must have been made by a Competent Person before this work practice is used. If a negative exposure assessment (NEA) has not been made, stop work and notify your supervisor.

The ceiling is a "controlled system." Do not contact or disturb ceiling unless you have been authorized by facility management.

Work Practice

1. Perform Pre-work activities on Level B checklist.
2. Tools, equipment and materials:
 - a. Tools as needed from the lists in General Procedure W1
 - b. Paint, rollers or low pressure airless sprayer, and other painting equipment
3. Complete Worker General Procedure W4 "Secure Work Area"
4. Put down drop sheet and complete Worker General Procedure W10 "Polyethylene Drop Cloth"
5. Place tools, equipment and materials needed onto drop cloth.
6. Paint ceiling using sprayer or rollers. If rollers are used, try to contact each area of the ceiling only once to avoid damage to ACM.
7. When painting is completed, clean up any loose debris using wet-wiping and/or HEPA vacuuming and roll up drop cloth. Dispose of paint rollers as ACM.
8. Perform clean-up and tear-down steps on Level B checklist to complete work.

S13 . Level C

Painting surfacing ACM.

Example The following are examples of work that can be performed using the procedures of this Level C work practice. If job conditions vary from the examples stop work and notify your supervisor.

- A. Paint asbestos-containing acoustical plaster that has not been previously painted.
- B. Paint asbestos-containing fireproofing.

Notes

The ceiling is a "controlled system." Do not contact or disturb ceiling unless authorized by facility management

These procedures involve working in an environment where there could be elevated levels of airborne asbestos. Do not attempt to use this work practice unless you have been trained as an asbestos abatement worker including training in the use of respirators and personal and area decontamination procedures.

Work Practice

1. Perform Pre-work activities on Level C checklist.
2. Tools, equipment and materials:
 - a. Tools as needed from the lists in General Procedure W1
 - b. Paint, and rollers or low pressure airless sprayer, and other painting equipment.
3. Complete Worker General Procedure W4 "Secure Work Area"
4. Put down drop sheet and complete Worker General Procedure W10 "Polyethylene Drop Cloth"
5. Erect mini-enclosure (or enclose entire room) and set up negative pressure system and/or HEPA filtered local exhaust ventilation according to General Procedure W20 "Mini-Enclosure"
6. Place tools, equipment and materials needed into enclosure.
7. Enter enclosure and paint ceiling as follows:
 - a. For acoustical plaster, use rollers or sprayer. If rollers are used, try to contact each area of the ceiling only once to avoid damage to ACM.
 - b. For fireproofing, use airless sprayer only.
8. When painting is completed, wet drop cloth with amended water, roll up and dispose of as ACM. Use HEPA vacuum and/or wet-wiping to clean up any dust or debris under drop cloth. Dispose of rollers as ACM.
9. Perform clean-up and tear-down steps on Level C checklist to complete work.

VI. Miscellaneous Materials

Work Practices



Figure 10: Miscellaneous Materials Location Illustration

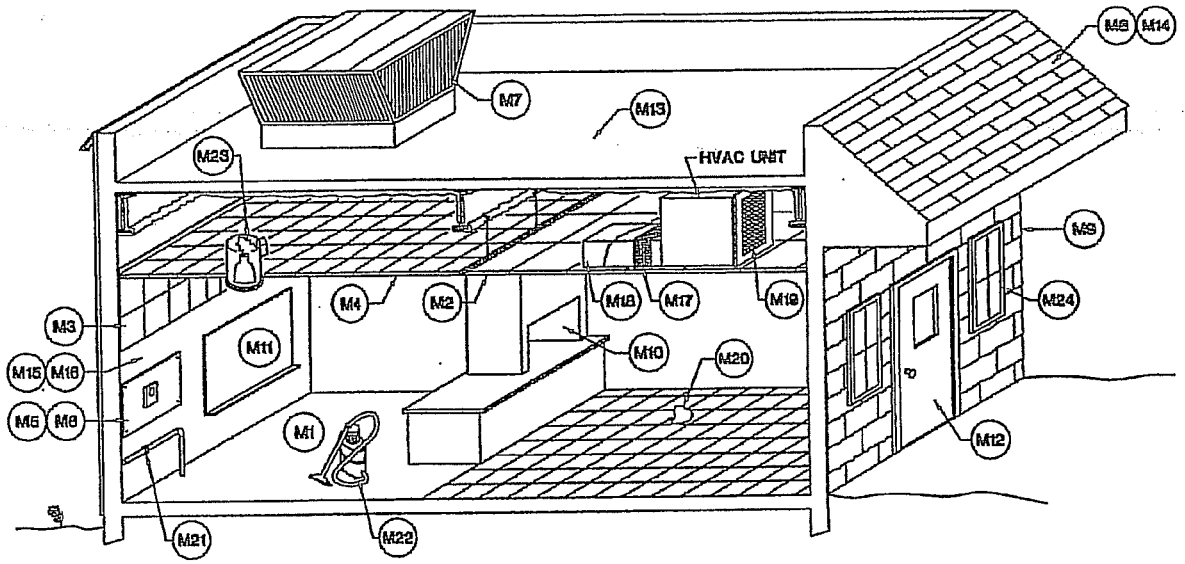

Section VI. Miscellaneous Materials Work Practices

Work Practices Location Illustration		235
<i>Code</i>	<i>Levels</i>	<i>Description</i>
M 1	A B	Clean potentially asbestos-contaminated carpet
M 2	A B C	Remove asbestos-containing ceiling panels in lay-in ceiling system ...
M 3	B C	Remove asbestos-containing ceiling tiles attached with adhesive
M 4	B C	Remove asbestos-containing ceiling tiles in spline ceiling system
M 5	B C	Cut or drill asbestos cement panels
M 6	A B C	Remove asbestos cement panels
M 7	A B	Remove asbestos cement cooling tower louvers
M 8	A B	Remove or replace asbestos cement roof shingles
M 9	A B	Remove and-replace asbestos cement siding shingles
M 10	A B C	Remove high-temperature resistant (HTR) asbestos cement panels
M 11	A B C	Remove asbestos-containing chalk board
M 12	A B C	Remove asbestos-containing fire door and/or door hardware
M 13	A B	Remove asbestos-containing built-up roofing
M 14	A B	Remove asbestos-containing asphalt shingles
M 15	B C	Cut or drill asbestos-containing drywall, plaster or drywall compound .
M 16	B C	Remove section of asbestos-containing drywall
M 17	A B C	Remove asbestos-containing flexible duct connector
M 18	A B C	Remove asbestos-containing paper or cloth from ductwork
M 19	B	Remove filters from HVAC unit
M 20	B	Clean up debris
M 21	A B C	Replace asbestos-containing gaskets/packing
M 22	B C	Emptying and changing filter in HEPA vacuum or changing filter in HEPA fan unit
M 23	A B C	Remove asbestos-wrapped wiring
M 24	A B C	Removing asbestos-containing caulking/glazing compound
M 25	A	Clean room that has asbestos-containing dust

Figure 10 illustrates typical applications of these work practices.

General Notes

Many of the miscellaneous materials in this section are non-friable. These materials are treated differently from friable materials (surfacing and TSI) by both OSHA and NESHAP.

OSHA

Work under this section is governed by the OSHA construction standard (29 CFR 1926.1101. The work is either Class II for non-friable materials, and Class III for friable and small quantities of non-friable materials. O&M work practices must be

designed to comply with these requirements.

Class II: OSHA defines work on non-friable materials as Class II work. In section (g) of the construction standard

(29 CFR 1926.1101) OSHA sets forth general "methods of compliance" for Class II work as supervision by a competent person, impermeable dropcloths, HEPA vacuums, wet methods and prompt clean up. If there is no Negative Exposure Assessment then critical barriers or some other barrier or isolations method must also be used. In addition, there are specific requirements for work on resilient flooring; roofing; siding, shingles, and transite (cement asbestos panels); and gaskets. In addition, OSHA gives specific requirements for intact roofing materials (roof cements, mastics, coatings, or flashings) that, "contain asbestos fibers encapsulated or coated by bituminous compounds." In the Compliance Directive (CPL 2-2.63) in the definition of Class II work, OSHA allows Class II work that removes no more material than will fit in a 60" disposal bag to be classified as Class III work.

OSHA allows considerable flexibility in the design of work practices, as long as airborne fiber levels are maintained below the OSHA PEL. If the work is considered as Class II, under requirements for Class II work OSHA allows the use of "Alternative Work Practices and Controls" as long as worker exposures will not exceed the PELs. 29 CFR 1926.1101(g)(8)(vi) requires that "the different or modified controls reduce direct and indirect employee exposure to below the PELs under all expected conditions of use and that the method meets the requirements of this [sic. the OSHA] standard." To meet this requirement, the controls developed by the O&M designer must reliably keep airborne fiber levels below the PELs. The work area where these controls are to be applied must be evaluated by a competent person.

Class III: Work on a small quantity of non-friable miscellaneous materials for maintenance purposes can be Class III. OSHA allows Class II work that removes no more material than will fit in a 60" disposal bag to be classified as Class III work. In section (g) of the construction standard (29 CFR 1926.1101) OSHA sets forth general "methods of compliance" for any work as HEPA vacuums, wet methods and prompt clean up. In addition Class III work must be performed using wet methods and local exhaust ventilation. If there is no Negative Exposure Assessment then the work area must be contained with impermeable dropcloths and sheet plastic barriers or their equivalent. If the work involves, "drilling, cutting, abrading, sanding, chipping, breaking, or sawing," then impermeable dropcloths and mini-enclosures, glovebags or another isolation measure are required. Respirators are required if the work is on surfacing or TSI or if there is no negative exposure assessment.

Both class II and Class III requirements allow open work practices as long as airborne fiber levels are maintained below the PELs. A great deal of the effort of designing work practices for miscellaneous materials will center around making a negative exposure assessment. Refer to the introduction for more information on making an NEA. The O&M program designer should become familiar with the OSHA requirements for Class II and Class III work as set forth in the construction standard (29 CFR 1926.1101) with amplifications and explanations in the Compliance Directive (CPL 202.63, November 3, 1995)

DESIGNING and IMPLEMENTING WORK PRACTICES

An O&M program will be easier and more practical to implement and more cost efficient if it is designed so that the majority of work can be performed without enclosures. For this to happen, each work practice needs to be developed to the point that there is no airborne exposure to asbestos (as defined by OSHA). In terms of the OSHA construction standard this means that a Negative Exposure Assessment (NEA) must be made.

The work practices given in this manual are examples of procedures that are typically useable for the situations described. The level of training, experience and skill of the staff performing the work, and the exact type of material and material conditions will vary from facility to facility. The O&M designer needs to adjust the work practices in the example to work for the specific materials and workers in a facility.

Level A: Level A work procedures involve work that contacts, but does not disturb asbestos-containing materials (ACM).

- **Design:** Non-friable materials can survive fairly high impacts without being disturbed. However, the designer should determine if the surface characteristics of the material are such that asbestos could be released from the surface upon contact even if the matrix of the material is not disturbed. For example: cement asbestos board can weather under acid rain to the extent that asbestos can be released from the surface by contact even though the panel is predominantly non-friable.

As Level A procedures are open, a negative exposure assessment is necessary. Workers performing Level A tasks need to have more than awareness training. Workers involved with roofing, siding, ceiling tiles, and transite need to have a minimum of 8 hours of training per category of material. Work on other materials requires training in general asbestos issues (paragraph (k)(9)(viii) of the construction standard), as well as specific work practices and engineering controls including "hand-on" training.

- **Implementation:** Worker should report back to the APM any changes in the condition of materials or other changes that could dictate a change in control strategies.

Level B: Level B work procedures involve work that disturbs ACM, but that use work procedures that control the release of asbestos well enough so that the work can be performed in the open. To comply with OSHA requirements, this requires certification under Class II requirements and a Negative Exposure assessment.

- **Design:** During design of the work practice the O&M designer (who must be a competent person) needs to either make the determination that airborne fiber levels during the use of the work practice will not exceed the OSHA PELs required for an alternative Class II work practice, and should also make a negative exposure assessment. Under the Class II requirements the designer must certify in writing that use of the work practice will, "reduce direct and indirect employee exposure to below

the PELs under all expected conditions of use,” and that the work practice meets the requirements of the OSHA standard. The requirements for an NEA are described in the introduction. Both the certification and NEA are based on exposure monitoring.

Several of the Level B work practices in this section offer examples that rely on an, “another isolation method” for drilling ACM. This is generally accomplished by the use of a collar around the drill that is attached to a HEPA vacuum. Used properly this can isolate the site of the drilling to the same extent as a mini-enclosure or glovebag, but in a much more portable and worker friendly manner. The ability of the HEPA collar to isolate the drilling needs to be demonstrated during design of the work practice by a negative exposure assessment. During testing of the work practice it would be prudent for the designer to perform the work inside of an enclosure such as a mini-enclosure. Under no circumstances should this be attempted inside of a glovebag. The use of power tools inside a glovebag is dangerous due to poor visibility and a high probability of catching the tool in the plastic of the bag. There are several other isolation methods known to members of the project committee

including drilling through shaving cream or a wet sponge, slowly hand drilling sodden material, and using the nozzle of HEPA vacuum for local area exhaust. The designer may want to try these techniques during development of the O&M.

- Implementation: Each time that work is assigned the asbestos program manager (APM) (who must also be a competent person) must evaluate the work area make a determination that the conditions at the specific job site are equivalent to those that existing during development of the work practice, so that the work practice is applicable.

Level C: Level C work procedures involve work that disturbs ACM, and during which the PELs could be exceeded or where, “drilling, cutting, abrading, sanding, chipping, breaking, or sawing,” is occurring.

- Design: Initial monitoring needs to be conducted to determine what respiratory protection and other worker protection requirements will be.
- Implementation: Periodic monitoring must be performed to validate the selection of respiratory protection.

NESHAP

The NESHAP regulates the disposal of ACM. Non-friable materials are treated differently from friable materials such as surfacing materials and thermal system insulation. Most miscellaneous (non-friable) materials are classified by the EPA NESHAP as Category I non-friable ACM. If Category I ACM has become friable, or will become friable, or has been

or will be subjected to sanding, grinding, cutting or abrading, it is defined as Regulated ACM by NESHAP, and its wetting, labeling and disposal requirements apply. State and local regulations may have different requirements, and these may be more stringent.

WORK PRACTICES:

Careful work practices should be the primary means used to prevent releases of asbestos fibers during O&M work. Such practices include control measures such as wetting and local exhaust that control or collect fibers at the source. The goal of all asbestos O&M work should be to prevent any exposure of the worker and unnecessary contamination of the work area, drop cloths, mini-enclosures or other secondary control devices. Mini-enclosures should never be used to excuse sloppy work or creation of "bigger" messes.

Drilling: The OSHA regulation requires that drilling be isolated by an enclosure. However, the work practices in this section offer several alternative isolation methods that the O&M designer may want to experiment with. **CAUTION:** before these procedures are used, the O&M designer must demonstrate that they are as effective at isolating the drilling as an enclosure. This is accomplished with a negative exposure assessment.

- A wet sponge can be used where small holes must be drilled in ACM. The sponge can be held over the location where the hole is needed and the hole can be drilled through the wet sponge. The sponge should help to keep any dust or debris wet.
- The hose of an operating HEPA vacuum can be placed near the cutting point of a drill bit or other tools.

- Shaving cream can be sprayed over an area where ACM will be cut or drilled to contain dust or debris. Any shaving cream used in this manner should be disposed of as ACM after use.
- Tools with HEPA filtered dust collection attachments.

Glovebag removal procedures as described in General Procedure W18 may be appropriate for use in certain small O&M tasks involving miscellaneous ACM, such as the removal of a small area of AC plaster where an enclosure is desired, changing the bag in a HEPA vacuum or removing a small amount of ductwork taping cloth.

If the O&M activity involves work on materials (such as asbestos cement board) that might have chemical residue present, either the residue will need to be properly removed prior to the start of the O&M work, or the O&M work will have to be performed dry. If dry removal is necessary, local exhaust ventilation and careful handling will need to be relied on to maintain airborne fiber levels within satisfactory limits. This approach would need to be validated during design of the O&M program. Cleaning might be necessary to reduce the possibility of a chemical reaction that could be caused by water, surfactants and/or other substances mixing with chemical residues during O&M work.

M1 . Summary

Clean potentially asbestos-contaminated carpet

Summary

This work practice describes the O&M procedures that can be used to substitute HEPA vacuuming of carpeting for normal vacuuming. This can be useful in situations where there could be a small periodic release from an ACM (e.g. in a room that has a soft acoustical finish that is within reach of the occupants and may be contacted upon occasion). This procedure can also be used for cleaning small areas of asbestos-contaminated carpet. If contamination is present due to a fiber release, see work practice M20.

Note: EPA's Green Book indicates that routine use of a special cleaning work practice is not required if asbestos-containing dust or debris is not present and deterioration or damage to ACM is unlikely. While NIBS is not recommending its use as a routine mandatory asbestos control procedure in this case, the Level A work practice is being provided for those operations and maintenance programs which choose to use it.

Examples

Level A: A. Clean potentially asbestos-contaminated carpet that has no visible contamination or analytical confirmation of asbestos contamination. ACM in room is in good condition.

Level B: A. Clean carpet that has some visual or analytical evidence of asbestos contamination.

Related Work Practices

- R 3 Install new resilient flooring or carpet over resilient asbestos flooring.
- R 8 Remove carpet over resilient asbestos flooring.

Worker Recommendations

One worker. A person with air monitoring training might be required. This person can be the worker.

M1 . Level A

Clean potentially asbestos-contaminated carpet

Example

The following is an example of work that can be performed using the procedures of this Level A work practice. If job conditions vary from the example stop work and notify your supervisor:

- A. Clean potentially asbestos-contaminated carpet that has no visible contamination or analytical confirmation of asbestos contamination. ACM in room is in good condition

Notes

A Negative Exposure Assessment must have been made by a Competent Person before this work practice is used. Verify that a negative exposure assessment (NEA) has been made. If an NEA cannot be verified, stop work and notify your supervisor.

Work Practice

1. Perform Pre-work activities on Level A checklist.
2. Tools, equipment and materials:
 - a. Tools as needed from the lists in General Procedure W1
 - b. Carpet attachment for HEPA vacuum
3. HEPA vacuum carpet using carpet attachment. Use Work Practice M22 if HEPA vacuum needs maintenance, or if bag or filter needs to be replaced.
4. Perform applicable steps on Level A checklist to complete work.

M1 . Level B

Clean potentially asbestos-contaminated carpet

Example

The following are examples of work that can be performed using the procedures of this Level B work practice. If job conditions vary from the examples stop work and notify your supervisor.

- A. Clean carpet that has some visual or analytical evidence of asbestos contamination.

Notes

A Negative Exposure Assessment must have been made by a Competent Person before this work practice is used. Verify that a negative exposure assessment (NEA) has been made. If an NEA cannot be verified, stop work and notify your supervisor.

Work Practice

1. Perform Pre-work activities on Level B checklist.
2. Tools, equipment and materials:
 - a. Tools as needed from the lists in General Procedure W1
 - b. HEPA vacuum with beater bar or carpet steam cleaning equipment.
3. Complete Worker General Procedure W4 "Secure Work Area"
4. Place tools, equipment and materials needed in work area.
5. Place tools, equipment and materials needed into work area.
6. Clean carpet using one of the following procedures:
 - a. With HEPA vacuum, vacuum contaminated area in parallel passes with each pass overlapping the previous by one half the width of the beater bar. Vacuum the area a second time, in the same manner, in passes at right angles to the first passes.
 - b. With steam cleaning equipment, clean carpet in accordance with manufacturer's equipment instructions. Clean in overlapping passes in one direction, and then a second time in overlapping passes at right angles to the first passes. Water from cleaning operation shall be disposed of in accordance with applicable regulations. See General Procedure W19.
7. Perform clean-up and tear-down steps on Level B checklist to complete work.

M5 . Summary

Cut or drill asbestos cement panels

Summary

This work practice covers the procedures cutting or drilling asbestos cement panels.

Examples

Level B: OSHA requires that during Class III (O&M) operations that involve, "drilling, cutting, abrading, sanding, chipping, breaking, or sawing of thermal system insulation or surfacing materials, the employer shall use impermeable dropcloths, and shall isolate the operation using mini-enclosures or glove bag systems ...or another isolation method." This work practice relies on the HEPA exhausted collar on the drill as, "another isolation method." During design of the O&M program the designer must be a competent person and must determine that the use of the HEPA exhausted collar as described in the work practice effectively isolates the drilling work. This evaluation should be based on an, "Initial exposure assessment," leading to a "Negative Exposure Assessment," (NEA) as described in the OSHA construction standard 29 CFR 1926.1101(f)(2). During implementation of the program, the APM must also be a competent person, and must make a determination that conditions at a specific job site are equivalent to those that existing during development of the work practice, so that the work practice is applicable. The work order issued to the person performing the work should inform them of the NEA and any conditions that are attached to the NEA. It is possible that after there has been some experience with the OSHA regulation the manufacturers of the type of equipment used in this work practice will make the proper evaluations and submissions to OSHA and provide a copy of this to the O&M program designer. In any case as a minimum requirement the supervisor that assigns work to maintenance staff should be a competent person able to evaluate the applicability of a dust collection collar with HEPA vacuum to a particular situation.

A. Drill a few holes in an asbestos cement board to install a new electrical panel.

Level C: A. Cut or drill a few holes in an asbestos cement panel to install a vent through panel using power tools.

Related Work Practices

M 6 Remove asbestos cement panels.

M 15 Cut or drill asbestos-containing drywall or drywall compound.

Worker Recommendation

One worker for Level B. Two workers for Level C. A person with air monitoring training might be required. This person can be a worker.

M5 . Level B

Cut or drill asbestos cement panels

Example

The following are examples of work that can be performed using the procedures of this Level B work practice. If job conditions vary from the examples stop work and notify your supervisor.

- A. Drill a few holes in an asbestos cement board to install a new electrical panel.

Notes

A Negative Exposure Assessment must have been made by a Competent Person before this work practice is used. Verify that a negative exposure assessment (NEA) has been made. If an NEA cannot be verified, stop work and notify your supervisor

Work Practice

1. Perform Pre-work activities on Level B checklist.
2. Tools, equipment and materials:
 - a. Tools as needed from the lists in General Procedure W1
 - b. Hand or power drill equipped with a HEPA vacuum dust collection attachment.
3. Complete Worker General Procedure W4 "Secure Work Area"
4. Put down drop sheet and complete Worker General Procedure W10 "Polyethylene Drop Cloth"
5. If accessible, install a drop cloth on the back side of the panel below where hole will penetrate through panel.
6. Place tools, equipment and materials needed onto drop cloth.
7. Adequately wet both sides of area to be drilled using garden sprayer with amended water. Keep water away from any electrical cords or equipment.
8. Drill hole using hand drill or power drill with operating HEPA vacuum attached. Wet drilling area using amended water.
9. As options, the following wetting methods/controls may be used:
 - a. For small holes, a wet sponge can be placed on both sides of the surface and the hole drilled through the sponges.
 - b. A HEPA vacuum hose may be used near the bit of a non-HEPA equipped drill, and on the back side if accessible.
 - c. Shaving cream can be sprayed on both sides of the drilling area to control dust and debris. Shaving cream must be wiped up and disposed of as ACM.
10. Wipe debris off drill using wet disposable towels and place towels into disposal bag
11. If back side was enclosed, insert wand of garden sprayer with amended water into back side enclosure and wet dust or debris. Remove back side enclosure and place into disposal bag. Wet wipe surfaces that were exposed inside back side enclosure.
12. Perform maintenance work and clean-up and tear-down steps on Level B checklist to complete work.

M5 . Level C

Cut or drill asbestos cement panels

Example

The following are examples of work that can be performed using the procedures of this Level C work practice. If job conditions vary from the examples stop work and notify your supervisor.

- A. Cut or drill a few holes in an asbestos cement panel to install a vent through panel using power tools.

Work Practice

1. Perform Pre-work activities on Level C checklist.
2. Tools, equipment and materials:
 - a. Tools as needed from the lists in General Procedure W1
 - b. Hand or power drill equipped with a HEPA vacuum dust collection attachment.
3. Complete Worker General Procedure W4 "Secure Work Area"
4. Put down drop sheet and complete Worker General Procedure W10 "Polyethylene Drop Cloth"
5. Erect mini-enclosure and set up negative pressure system and/or HEPA filtered local exhaust ventilation according to General Procedure W20 "Mini-Enclosure"
6. If accessible, enclose back side of panel to catch dust and debris where hole will penetrate through panel.
7. Place tools, equipment and materials needed into enclosure.
8. Enter enclosure and adequately wet both sides of area to be cut or drilled using garden sprayer with amended water. Keep water away from any electrical cords or equipment.
9. Cut or drill hole(s) using saw or drill. Power tools should have an operating HEPA vacuum attached. Wet cutting area during drilling or cutting using amended water.
10. As options, the following wetting methods/controls may be used:
 - a. For small holes, a wet sponge can be placed on both sides of the surface and the hole drilled through the sponges.
 - b. A HEPA vacuum hose may be used near the bit of a non-HEPA equipped drill, and on the back side if accessible.
 - c. Shaving cream can be sprayed on both sides of the drilling area to control dust and debris. Shaving cream must be wiped up and disposed of as ACM.
11. Remove panel piece and wet wipe debris off drill or saw using wet disposable towels and place towels and debris into disposal bag.

M15 . Level C ...continued

12. If back side was enclosed, insert wand of garden sprayer with amended water into back side enclosure and wet dust or debris. Remove back side enclosure and place into disposal bag. Wet wipe surfaces that were exposed inside back side enclosure.
13. Perform maintenance work and clean-up and tear-down steps on Level C checklist to complete work.

M6 . Summary

Remove asbestos cement panels

Summary

This work practice covers the procedures for removing a small number of asbestos cement panels to support O&M work. This procedure can be used for asbestos cement range hoods.

Examples

- Level A:** A. Remove several corrugated or flat asbestos cement panels that are painted or in good condition, and have fasteners that can be easily removed.
- Level B:** A. Remove several corrugated or flat asbestos cement panels in fair condition.
- Level C:** A. Remove several corrugated or flat asbestos cement panels in poor condition which have become friable and where dust or powder may be generated during removal.

Related Work Practices

- M 5** Cut or drill asbestos cement panels.
- M 12** Remove asbestos-containing fire door.

Worker Recommendations

One worker for Level A and Level B. Two workers for Level C. Panel size may necessitate two or more workers. A person with air monitoring training might be required. This person can be a worker.

M6 . Level A

Remove asbestos cement panels

Example

The following are examples of work that can be performed using the procedures of this Level A work practice. If job conditions vary from the examples stop work and notify your supervisor.

- A. Remove several corrugated or flat asbestos cement panels that are painted or in good condition, and have fasteners that can be easily removed.

Notes

A Negative Exposure Assessment must have been made by a Competent Person before this work practice is used. Verify that a negative exposure assessment (NEA) has been made. If an NEA cannot be verified, stop work and notify your supervisor.

Work Practice

1. Perform Pre-work activities on Level A checklist.
2. Tools, equipment and materials:
 - a. Tools as needed from the lists in General Procedure W1
 - b. Tools as needed to remove panel fasteners (slatter's ripper, nail clipper, screwdriver)
3. Complete Worker General Procedure W4 "Secure Work Area"
4. Place tools, equipment and materials needed in work area.
5. Adequately wet panels to be removed with amended water. Remove fasteners holding panel in place. Clean fasteners if they are to be reused. Dispose of fasteners as ACM if not being reused.
6. Remove panel and wrap in two (2) layers of polyethylene sheet for disposal as ACM.
7. Perform maintenance work and clean-up and tear-down steps on Level A checklist to complete work.

M6 . Level B

Remove asbestos cement panels

Example

The following are examples of work that can be performed using the procedures of this Level B work practice. If job conditions vary from the examples stop work and notify your supervisor.

- A. Remove several corrugated or flat cement asbestos panels in fair condition.

Notes

A Negative Exposure Assessment must have been made by a Competent Person before this work practice is used. Verify that a negative exposure assessment (NEA) has been made. If an NEA cannot be verified, stop work and notify your supervisor

If activated electrical equipment is in work area, do not wet, stop work, and notify your supervisor.

Work Practice

1. Perform Pre-work activities on Level B checklist.
2. Tools, equipment and materials:
 - a. Tools as needed from the lists in General Procedure W1
 - b. Tools as needed to remove panel fasteners (slatter's ripper, nail clipper, screwdriver)
3. Complete Worker General Procedure W4 "Secure Work Area"
4. Put down drop sheet and complete Worker General Procedure W10 "Polyethylene Drop Cloth"
5. Place tools, equipment and materials needed onto drop cloth.
6. Adequately wet panel(s) to be removed using garden sprayer with amended water.
7. Remove fasteners holding panel in place. HEPA vacuum and wet fasteners as they are removed. Clean fasteners using water if they are to be reused. Dispose of fasteners as ACM if not being reused.
8. Remove panel and wrap in two (2) layers of polyethylene sheet for disposal as ACM.
9. HEPA vacuum and wet wipe surfaces to which panel was attached. HEPA vacuum and wet wipe up any dust or debris from panel removal.
10. Perform maintenance work and clean-up and tear-down steps on Level B checklist to complete work.

M6 . Level C

Remove asbestos cement panels

Example

The following are examples of work that can be performed using the procedures of this Level C work practice. If job conditions vary from the examples stop work and notify your supervisor.

- A. Remove several corrugated or flat asbestos cement panels in poor condition which have become friable and where dust or powder may be generated during removal.

Notes

If activated electrical equipment is in work area, do not wet, stop work, and notify your supervisor.

Work Practice

1. Perform Pre-work activities on Level C checklist.
2. Tools, equipment and materials:
 - a. Tools as needed from the lists in General Procedure W1
 - b. Tools as needed to remove panel fasteners (slatter's ripper, nail clipper, screwdriver)
3. Complete Worker General Procedure W4 "Secure Work Area"
4. Put down drop sheet and complete Worker General Procedure W10 "Polyethylene Drop Cloth"
5. Erect mini-enclosure and set up negative pressure system and/or HEPA filtered local exhaust ventilation according to General Procedure W20 "Mini-Enclosure"
6. Place tools, equipment and materials needed into enclosure.
7. Enter enclosure and adequately wet panel(s) to be removed using garden sprayer with amended water.
8. Remove fasteners holding panel in place. HEPA vacuum and wet fasteners as they are removed. Clean fasteners using water if they are to be reused. Dispose of fasteners as ACM if not being reused.
9. Remove panel and wrap in two (2) layers of polyethylene sheet for disposal as ACM. If panel breaks or chips and small debris results from removal, collect and dispose of in disposal bags or containers.
10. HEPA vacuum and wet wipe surfaces to which panel was attached. HEPA vacuum and wet wipe up any dust or debris from panel removal.
11. Perform maintenance work and clean-up and tear-down steps on Level C checklist to complete work.

M12 . Summary

Remove asbestos-containing fire door and/or door hardware

Summary

This procedure sets forth the O&M work procedures to remove an asbestos-containing fire door or door hardware in an asbestos-containing fire door. Cutting or drilling into asbestos containing doors are included as Level C work.

Examples

- Level A:** A. Remove an asbestos-containing fire door that is in good condition for replacement.
B. Replace a lockset or closer on asbestos-containing fire door in good condition.
Lockset does not penetrate asbestos core of door.

- Level B:** A. Remove an asbestos-containing fire door that is damaged.
B. Replace a lockset or closer on asbestos-containing fire door in poor condition.
Lockset may penetrate asbestos core of door.

- Level C:** A. Cut a door to install new window.
B. Drill a hole for new lockset through asbestos core of a door.

Related Work Practices

None.

Worker Recommendations

One worker for Level A and Level B. Two workers may facilitate handling of heavy doors being removed. Two workers for Level C. A person with air monitoring training might be required. This person can be a worker.

M12 . Level A

Remove asbestos-containing fire door and/or door hardware

Example

The following are examples of work that can be performed using the procedures of this Level A work practice. If job conditions vary from the examples stop work and notify your supervisor.

- A. Remove an asbestos-containing fire door that is in good condition for replacement.
- B. Replace a lockset or closer on asbestos-containing fire door in good condition.
Lockset does not penetrate asbestos core of door.

Notes

A Negative Exposure Assessment must have been made by a Competent Person before this work practice is used. Verify that a negative exposure assessment (NEA) has been made. If an NEA cannot be verified, stop work and notify your supervisor.

Work Practice

1. Perform Pre-work activities on Level A checklist.
2. Tools, equipment and materials:
 - a. Tools as needed from the lists in General Procedure W1
 - b. Screwdriver and tools needed for hardware or door removal
3. Complete Worker General Procedure W4 "Secure Work Area"
4. Place tools, equipment and materials needed in work area.
5. If door is equipped with a closer, detach closer arm from door frame. Remove screws attaching closer to door. HEPA vacuum or wet clean screws, closer, and area where closer was attached to door. Thoroughly clean closer and parts if they will be re-used. If closer will not be re-used, dispose of as ACM waste.
6. Remove lockset from door using procedures used for closer. HEPA or wet wipe vacuum lockset if it will be re-used or disposed of as ACM waste. Use Work Practice M22 if HEPA vacuum needs maintenance, or if bag or filter needs to be replaced.
7. Lay two layers of polyethylene sheet on floor for wrapping door.
8. Remove hinge pins or screws attaching hinges to door frame. Lay door on polyethylene.
9. If hinges are to be re-used, remove from door following procedures used for closer. If hinges are to be disposed of, leave hinges attached to door.
10. Wrap door for disposal.
11. Perform clean-up and tear-down steps on Level A checklist to complete work.

M12 . Level B

Remove asbestos-containing fire door and/or door hardware

Example

The following are examples of work that can be performed using the procedures of this Level B work practice. If job conditions vary from the examples stop work and notify your supervisor.

- A. Remove an asbestos-containing fire door that is damaged.
- B. Replace a lockset or closer on asbestos-containing fire door in poor condition. Lockset may penetrate asbestos core of door.

Notes

A Negative Exposure Assessment must have been made by a Competent Person before this work practice is used. If a negative exposure assessment (NEA) has not been made, stop work and notify your supervisor.

Work Practice

1. Perform Pre-work activities on Level B checklist.
2. Tools, equipment and materials:
 - a. Tools as needed from the lists in General Procedure W1
 - b. Screwdrivers and tools needed for hardware and door removal
3. Complete Worker General Procedure W4 "Secure Work Area"
4. Put down drop sheet and complete Worker General Procedure W10 "Polyethylene Drop Cloth."
5. Place tools, equipment and materials needed on drop cloth.
6. Wet any damaged areas with amended water.
7. If door is equipped with a closer, detach closer arm from door frame. Wet closer and area where closer is attached to door using amended water. Remove screws attaching closer to door. Wet screws during removal and area behind closer once all screws are removed. HEPA vacuum and wet wipe closer and screws if it is to be re-used. If closer and screws will not be re-used, dispose of as ACM waste.
8. Remove lockset from door using procedures used for closer. HEPA vacuum lockset if it will be re-used or dispose of as ACM waste.
9. Lay two layers of polyethylene sheet on floor for wrapping door.
10. Remove hinge pins or screws attaching hinges to door frame. Lay door on polyethylene.

M12 . Level B...continued

11. If hinges are to be re-used, remove from door following procedures used for closer.
If hinges are to be disposed of, leave hinges attached to door.
12. Wrap door for disposal.
13. Perform clean-up and tear-down steps on Level B checklist to complete work.

M12 . Level C

Remove asbestos-containing fire door and/or door hardware

Example

The following are examples of work that can be performed using the procedures of this Level C work practice. If job conditions vary from the examples stop work and notify your supervisor.

- A. Cut a door to install new window.
- B. Drill a hole for new lockset through asbestos core of a door.

Notes

Perform work in a mini-enclosure located at door, or remove door and take to remote mini-enclosure

Work Practice

1. Perform Pre-work activities on Level C checklist.
2. Tools, equipment and materials:
 - a. Tools as needed from the lists in General Procedure W1
 - b. Tools needed to cut or drill door, with HEPA filtered dust collection attachment if possible.
 - c. New lockset or window
3. Complete Worker General Procedure W4 "Secure Work Area"
4. Put down drop sheet and complete Worker General Procedure W10 "Polyethylene Drop Cloth."
5. Erect mini-enclosure and set up negative pressure system and/or HEPA filtered local exhaust ventilation according to General Procedure W20 "Mini-Enclosure." Enclosures can be installed at door location, or door can be removed and taken into an enclosure.
6. Place tools, equipment and materials needed into enclosure.
7. Wet area where hole will be cut or drilled.
8. Cut or drill door as required. Wet cutting or drilling location during work.
9. Place cut piece of door or debris from drilling into ACM disposal bags. HEPA vacuum or wet wipe new hole area and clean up any debris.
10. Install window or lockset and perform clean-up and tear-down steps on Level C checklist to complete work.

M13 . Summary

Remove asbestos-containing built-up roofing

Summary

This work practice describes the work required to remove a small amount of asbestos-containing built-up roofing or flashing for maintenance or repair work.

Examples

- Level A:** A. Replace or remove intact less than 25 square feet of asbestos containing built-up roofing without creating visible dust, to perform patching, repair work, or install new vent or stack.
- Level B:** A. Replace or remove a small area of asbestos containing built-up roofing that is damaged, may become non-intact or create visible dust during removal, or where more than 25 square feet is removed
-

Related Work Practices

- M 8 Remove and replace asbestos cement roof shingles.
- M 14 Remove asbestos-containing asphalt shingles.
-

Worker Recommendations

One worker is usually sufficient. Two or more workers may be needed to increase efficiency or for additional health and/or safety considerations. A person with air monitoring training might be required. This person can be a worker.

M13 . Level A

Remove asbestos-containing built-up roofing

Example

The following are examples of work that can be performed using the procedures of this Level A work practice. If job conditions vary from the examples stop work and notify your supervisor.

- A. Replace or remove intact less than 25 square feet of asbestos containing built-up roofing without creating visible dust, to perform patching, repair work, or install new vent or stack.

Notes

A Negative Exposure Assessment must have been made by a Competent Person before this work practice is used. Verify that a negative exposure assessment (NEA) has been made. If an NEA cannot be verified, stop work and notify your supervisor.

Use fall prevention measures (including safety harnesses, a warning line system with safety monitor, and/or a motion stopping system) as required by OSHA for roofing work. Roofing removal work shall be completed before any penetrations through the roof deck are made. Coordinate work with O & M Work Practice S7 if surfacing is present on underside of deck.

Work Practice

1. Perform Pre-work activities on Level A checklist.
2. Tools, equipment and materials:
 - a. Tools as needed from the lists in General Procedure W1
 - b. Safety harness/warning line system and/or motion stopping system
 - c. Hook knife
 - d. Scraper 2-3" (50-75 mm) wide stiff blade
 - e. Replacement roofing materials and tools
 - f. Rope for lowering bags
3. Complete Worker General Procedure W4 "Secure Work Area"
4. Place tools, equipment and materials needed in work area.
5. Cut around area to be removed using hand tools. Note that several layers may be present.
6. Scrape up roofing and place into disposal bags. Remove any remaining roofing debris in removal area using scraper and place into disposed bags. Lower bags to ground.
7. Perform maintenance/repair work and clean-up and tear-down steps on Level A checklist to complete work.

M13 . Level B

Remove asbestos-containing built-up roofing

Example

The following are examples of work that can be performed using the procedures of this Level B work practice. If job conditions vary from the examples stop work and notify your supervisor.

- A. Replace or remove a small area of asbestos containing built-up roofing that is damaged, may become non-intact or create visible dust during removal, or where more than 25 square feet is removed

Notes

A Negative Exposure Assessment must have been made by a Competent Person before this work practice is used. If a negative exposure assessment (NEA) has not been made, stop work and notify your supervisor.

Use fall prevention measures (including safety harnesses, a warning line system with safety monitor, and/or a motion stopping system) as required by OSHA for roofing work. Roofing removal work shall be completed before any penetrations through the roof deck are made. Coordinate work with O & M Work Practice S7 if surfacing ACM is present on underside of deck.

Work Practice

1. Perform Pre-work activities on Level B checklist.
2. Tools, equipment and materials:
 - a. Tools as needed from the lists in General Procedure W1
 - b. Safety harness/warning line system and/or motion stopping system
 - c. Hook knife
 - d. Scraper 2-3" (50-75 mm) wide stiff blade
 - e. Replacement roofing materials and tools
 - f. Rope for lowering bags
3. Prepare work area with barrier tape according to General Procedure W4 "Secure Work Area"
4. Put down drop sheet and complete Worker General Procedure W10 "Polyethylene Drop Cloth." Seal any windows, HVAC units, air intakes or other openings that could allow fibers from work area into building. Do not seal any plumbing vents in work area.
5. Place tools, equipment and materials needed in work area.

M13 . Level B ... continued

6. If feasible and safe, adequately wet roofing to be removed using garden sprayer with amended water. The use of wetting and amended water for roofing work should be limited for the following reasons:
 - a. Wet roofing can create slip hazards.
 - b. Roofing mastic/coal tar/bitumen will not adhere to wet surfaces.
 - c. Water can damage materials below the roof membrane.
7. Cut around area to be removed using hand tools. Wet cutting area using amended water. Note that several layers may be present.
8. Scrape up roofing section and place into disposal bags. Wet and remove any roofing debris in removal area using scraper. Lower bags to ground.
9. HEPA vacuum or wet wipe removal area. Use HEPA vacuum where needed to clean up ACM. It may not be appropriate or necessary to use HEPA vacuum on non-ACM.
10. Perform maintenance/repair work and clean-up and tear-down steps on Level B checklist to complete work.

M14 . Summary

Remove asbestos-containing asphalt shingles

Summary

This work practice describes the work required to remove a small number of asbestos-containing shingles for maintenance or repair work.

Examples

- Level A:** A. Remove intact less than 25 square feet of asbestos containing asphalt shingles without creating visible dust, to perform patching, repair work, or install new vent or stack.
- Level B:** A. Replace or remove asbestos containing asphalt shingles that are damaged to the extent that they have become friable, may become non-intact or create visible dust during removal, or where more than 25 square feet is removed

Related Work Practices

- M 8 Remove and replace asbestos cement roof shingles.
- M 13 Remove asbestos-containing built-up roofing.

Worker Recommendations

One worker is usually sufficient. Two or more workers may be needed to increase efficiency or for additional health and/or safety considerations. A person with air monitoring training might be required. This person can be a worker.

M14 . Level A

Remove asbestos-containing asphalt shingles

Example

The following are examples of work that can be performed using the procedures of this Level A work practice. If job conditions vary from the examples stop work and notify your supervisor.

- A. Remove intact less than 25 square feet of asbestos containing asphalt shingles without creating visible dust, to perform patching, repair work, or install new vent or stack.

Notes

A Negative Exposure Assessment must have been made by a Competent Person before this work practice is used. Verify that a negative exposure assessment (NEA) has been made. If an NEA cannot be verified, stop work and notify your supervisor.

Use fall prevention measures (including safety harnesses, a warning line system with safety monitor, and/or a motion stopping system) as required by OSHA for roofing work. Roofing removal work shall be completed before any penetrations are made in the roof deck.

Work Practice

1. Perform Pre-work activities on Level A checklist.
2. Tools, equipment and materials:
 - a. Tools as needed from the lists in General Procedure W1
 - b. Garden sprayer with amended water
 - c. Scraper 2-3" (50-75 mm) wide stiff blade
 - d. Roofing repair materials (shingles, roofing cement, nails)
 - e. Hammer
 - f. Pry bar
 - g. Safety harness/warning line system and/or motion stopping system
 - h. Non-slip boots
 - i. Spray encapsulant (if used)
3. Complete Worker General Procedure W4 "Secure Work Area."
4. Place tools, equipment and materials needed in work area.
5. Slide scraper under bottom shingle and twist scraper to break shingle seal. Remove entire shingle or sections of 3-Tab type shingles. Perimeter of removal area must have clean, straight vertical cuts to allow installation of new shingles. Note that several layers may be present.

M14 . Level A ... continued

6. Continue removing shingles one at a time following the steps used for the first shingle until area needed is removed. Place all shingles into disposal bags.
7. Do not drop shingles or disposal bags to the ground.
8. Pry up tabs on shingles immediately above removal area to facilitate installing new shingles.
9. Perform maintenance work and clean-up and tear-down steps on Level A checklist to complete work. Use roofing cement on tabs of existing shingles to seal them to new shingles.

M14 . Level B

Remove asbestos-containing asphalt shingles

Example

The following are examples of work that can be performed using the procedures of this Level B work practice. If job conditions vary from the examples stop work and notify your supervisor.

- A. Replace or remove asbestos containing asphalt shingles that are damaged to the extent that they have become friable, may become non-intact or create visible dust during removal, or where more than 25 square feet is removed Remove asbestos-containing asphalt shingles in poor condition to repair roof leak. Shingles are damaged to the extent that they have become friable.

Notes

A Negative Exposure Assessment must have been made by a Competent Person before this work practice is used. If a negative exposure assessment (NEA) has not been made, stop work and notify your supervisor.

Use fall prevention measures (including safety harnesses, a warning line system with safety monitor, and/or a motion stopping system) as required by OSHA for roofing work. Roofing removal work shall be completed before any penetrations are made in the roof leak.

Work Practice

1. Perform Pre-work activities on Level B checklist.
2. Tools, equipment and materials:
 - a. Tools as needed from the lists in General Procedure W1
 - b. Scraper 2-3" (50-75 mm) wide stiff blade
 - c. Roofing repair materials (shingles, roofing cement, nails)
 - d. Hammer
 - e. Pry bar
 - f. Safety harness/warning line system and/or motion stopping system
 - g. Non-slip boots
 - h. Spray encapsulant (if used)
3. Prepare work area with barrier tape according to General Procedure W4 "Secure Work Area"
4. Put down drop sheet and complete Worker General Procedure W10 "Polyethylene Drop Cloth." Seal over any windows, HVAC units, air intakes or other openings that could allow fibers from work area into building. Do not seal over any plumbing vents in work area.
5. Place tools, equipment and materials needed in work area.

M14 . Level B ... continued

6. If feasible and safe, adequately wet area of shingles to be removed with amended water or encapsulant. The use of wetting and amended water for roofing work should be limited for the following reasons:
 - a. Wet roofing can create slip hazards.
 - b. Roofing mastic/coal tar/bitumen will not adhere to wet surfaces.
 - c. Water can damage materials below the roof membrane.
7. Slide scraper under bottom shingle and twist scraper to break shingle seal. Remove entire shingle or sections of 3-Tab type shingles. Wet underside of shingles as they are removed. Perimeter of removal area must have clean, straight vertical cuts to allow installation of new shingles. Note that several layers may be present.
8. Continue removing shingles one at a time following the steps used for the first shingle until area needed is removed. Place all shingles into disposal bags.
9. Do not drop shingles of disposal bag.
10. Pry up tabs on shingles immediately above removal area to facilitate installing new shingles.
11. HEPA vacuum or wet wipe removal area. Use HEPA vacuum where needed to clean up ACM. It may not be appropriate or necessary to use HEPA vacuum on non-ACM.
12. Perform maintenance work and clean-up and tear-down steps on Level B checklist to complete work. Use roofing cement on tabs of existing shingles to seal them to new shingles.

M15 . Summary

Cut or drill asbestos-containing drywall, plaster or drywall compound

Summary

This work practice covers the procedures for cutting or drilling of asbestos-containing drywall or plaster. Joint compounds and tape are also covered by this procedure.

Examples

Level B: OSHA requires that during Class III (O&M) operations that involve, "drilling, cutting, abrading, sanding, chipping, breaking, or sawing of thermal system insulation or surfacing materials, the employer shall use impermeable drop cloths, and shall isolate the operation using mini-enclosures or glove bag systems ...or another isolation method." This work practice relies on a HEPA exhausted collar on the drill, shaving cream, or a wet sponge as, "another isolation method." During design of the O&M program the designer must be a competent person and must determine that the use of these techniques as described in the work practice effectively isolates the drilling or cutting work. This evaluation should be based on an, "Initial exposure assessment," leading to a "Negative Exposure Assessment," (NEA) as described in the OSHA construction standard 29 CFR 1926.1101(f)(2). During implementation of the program, the APM must also be a competent person, and must make a determination that conditions at a specific job site are equivalent to those that existing during development of the work practice, so that the work practice is applicable. The work order issued to the person performing the work should inform them of the NEA and any conditions that are attached to the NEA. It is possible that after there has been some experience with the OSHA regulation the manufacturers of the type of equipment used in this work practice will make the proper evaluations and submissions to OSHA and be able to provide this to the designers of O&M programs. In any case, as a minimum requirement the supervisor that assigns work to the maintenance staff should be a competent person able to evaluate the applicability of the work procedures to a particular situation.

- A. Install new electrical receptacle or ceiling junction box in asbestos-containing drywall using hand tools.
- B. Drill holes to attach conduit to asbestos-containing drywall using a drill with a HEPA exhausted collar attachment.
- C. Drill holes in asbestos-containing joint compound where drywall is non-asbestos.

Level C: The OSHA construction standard requires that activities involving drilling, cutting, abrading, etc. take place inside of mini-enclosures or glovebags. This will help protect the building environment, but in the case of mini-enclosures may increase exposures for workers and complicate clean up of the mini-enclosure. The work practice should always require that the careful work procedures of Level B be used inside of mini-enclosures. This will help protect workers and will simplify cleanup of the mini-enclosure interior. Use of power tools inside of a glovebag could be dangerous and should never be allowed.

M15 . Summary ... continued

A. Install conduit or ductwork through asbestos-containing drywall using power tools.

Related Work Practices

- M 5 Cut or drill asbestos cement panels.
 - M 6 Remove asbestos cement panels.
-

Worker Recommendations

One worker is usually sufficient for Level B. Two workers for Level C. Two workers may be needed to increase efficiency or for additional health and/or safety considerations. Workers should be trained in working with drywall and asbestos. A person with air monitoring training might be required. This person can be a worker.

M15 . Level B

Cut or drill asbestos-containing drywall, plaster or drywall compound

Example

The following are examples of work that can be performed using the procedures of this Level B work practice. If job conditions vary from the examples stop work and notify your supervisor.

- A. Install new electrical receptacle or ceiling junction box in asbestos-containing drywall using hand tools.
- B. Drill holes to attach conduit to asbestos-containing drywall using a drill with a HEPA exhausted collar attachment.
- C. Drill holes in asbestos-containing joint compound where drywall is non-asbestos

Notes

A Negative Exposure Assessment must have been made by a Competent Person before this work practice is used. If a negative exposure assessment (NEA) has not been made, stop work and notify your supervisor.

Work Practice

1. Perform Pre-work activities on Level B checklist.
2. Tools, equipment and materials:
 - a. Tools as needed from the lists in General Procedure W1
 - b. Drill or hole saw (as needed) equipped with HEPA filtered dust collection
 - c. Maintenance work materials
3. Complete Worker General Procedure W4 "Secure Work Area"
4. Put down drop sheet and complete Worker General Procedure W10 "Polyethylene Drop Cloth."
5. If accessible, also install a drop cloth on back side of drywall if hole(s) will penetrate through wall.
6. Place tools, equipment and materials needed onto drop cloth.
7. Mark area to be cut or drilled.
8. Adequately wet area to be cut using garden sprayer with amended water. As alternate methods, holes can be drilled/cut through a wet sponge or shaving cream on both sides.
9. Cut new hole using utility knife, hand tools or power tools with HEPA filtered dust collection. Wet the cutting area using amended water during cutting or drilling.

M15 . Level B ... continued

10. Remove piece of cut drywall and place into disposal bag. If wet sponges were used, place sponges into disposal bag.
11. HEPA vacuum removal area and areas accessible from hole.
12. HEPA vacuum and wet wipe up any accessible dust or debris generated on back side. Wet wipe drop cloth and surfaces adjacent to area where hole was cut or drilled. Remove drop cloth and place into disposal bags.
13. Perform maintenance work and clean-up and tear-down steps on Level B checklist to complete work.

M15 . Level C

Cut or drill asbestos-containing drywall, plaster or drywall compound

Example

The following are examples of work that can be performed using the procedures of this Level C work practice. If job conditions vary from the examples stop work and notify your supervisor.

- A. Install conduit or ductwork through asbestos-containing drywall using power tools.

Notes

Inside of enclosure, use Level B work practices to minimize fiber release for procedures that involve drilling, cutting, abrading, sanding, chipping, breaking or sawing.

Do not use power tools inside glovebags.

A Negative Exposure Assessment must have been made by a Competent Person before this work practice is used. If a negative exposure assessment (NEA) has not been made, stop work and notify your supervisor.

Work Practice

1. Perform Pre-work activities on Level C checklist.
2. Tools, equipment and materials:
 - a. Tools as needed from the lists in General Procedure W1
 - b. Drill or saw (as needed) with HEPA filtered dust collection attachment
 - c. Maintenance work materials.
3. Complete Worker General Procedure W4 "Secure Work Area"
4. Put down drop sheet and complete Worker General Procedure W10 "Polyethylene Drop Cloth."
5. Erect mini-enclosure and set up negative pressure system and/or HEPA filtered local exhaust ventilation according to General Procedure W20 "Mini-Enclosure"
6. If back side of drywall is accessible, enclose area if hole(s) will penetrate through wall. Provide negative air in backside enclosure if possible. A glovebag may be used as an enclosure for small work areas.
7. Place tools, equipment and materials needed into enclosure. Include a second HEPA vacuum outside of the enclosure with hose and nozzle extending inside enclosure for any power tools to be used for cutting or drilling.
8. Enter enclosure and mark area to be cut or drilled.
9. Adequately wet area to be cut using garden sprayer with amended water.

M15 . Level C ... continued

10. Cut new hole using utility knife, hole saw or drill. Power tools must have an operating HEPA vacuum attached during cutting. Wet the cutting area using amended water during cutting or drilling.
11. Remove piece of cut drywall and place into disposal bag.
12. HEPA vacuum removal area and areas accessible from hole.
13. If dust or debris is generated on back side, insert wand of garden sprayer into back side of enclosure and adequately wet any dust or debris present. Remove back-side enclosure, place into disposal bags, and wet wipe surfaces that were exposed inside enclosure.
14. Perform maintenance work and clean-up and tear-down steps on Level C checklist to complete work.

M16 . Summary

Remove section of asbestos-containing drywall

Summary

This work practice describes the work required to remove a small area of asbestos-containing drywall, or non-ACM drywall with ACM joint compound in support of O&M work.

Examples

Level B: A. Remove small area of asbestos-containing drywall in good condition using non-powered hand tools. Low dust Level expected.

Level C: A. Replace damaged section of asbestos-containing drywall or drywall adhered to studs using hand tools or power tools with HEPA vacuum dust collection attachments.

Related Work Practices

M 15 Cut or drill asbestos-containing drywall or drywall compound.

Worker Recommendations

One worker is usually sufficient for Level B. Two workers for Level C. Two or more workers may be needed to increase efficiency or for additional health and/or safety considerations. A person with air monitoring training might be required. This person can be a worker.

M16 . Level B

Remove section of asbestos-containing drywall

Example

The following are examples of work that can be performed using the procedures of this Level B work practice. If job conditions vary from the examples stop work and notify your supervisor.

- A. Remove small area of asbestos-containing drywall in good condition using non-powered hand tools. Low dust Level expected.

Notes

A Negative Exposure Assessment must have been made by a Competent Person before this work practice is used. If a negative exposure assessment (NEA) has not been made, stop work and notify your supervisor.

This work practice must be used in conjunction with General Procedures W1, W10 and a Level B Worker Checklist. The worker checklist includes tasks that must be performed before these work practices are begun.

Work Practice

1. Perform Pre-work activities on Level B checklist.
2. Tools, equipment and materials:
 - a. Tools as needed from the lists in General Procedure W1
 - b. Hand tools as needed
 - c. Pry bars
3. Complete Worker General Procedure W4 "Secure Work Area"
4. Put down drop sheet and complete Worker General Procedure W10 "Polyethylene Drop Cloth."
5. Place tools, equipment and materials needed onto drop cloth.
6. Adequately wet entire area of drywall to be removed using garden sprayer with amended water.
7. Cut around perimeter of area to be removed using hand tools. Wet cutting area with amended water during cutting.
8. If drywall remains attached to studs or substrate, use pry bar to pull sheet out enough so edge can be gripped with hands. Mist cavity behind drywall and back side of drywall to be removed with amended water.
9. Pull sheet out so sheet folds at fastener line or sheet is pulled away from fasteners. Adequately wet fold or holes from fasteners.
10. Repeat step above at other attachment points, remove drywall piece, and package for disposal.

M16 . Level B ... continued

11. Remove fasteners from studs or substrate and place into disposal bags. Clean any debris left on studs or substrate using amended water and nylon brush.
12. Pick up any debris and place into disposal bags. HEPA vacuum and wet wipe up any dust generated.
13. Perform maintenance work and clean-up and tear-down steps on Level B checklist to complete work.

M16 . Level C

Remove section of asbestos-containing drywall

Example

The following are examples of work that can be performed using the procedures of this Level C work practice. If job conditions vary from the examples stop work and notify your supervisor.

- A. Replace damaged section of asbestos-containing drywall or drywall adhered to studs using hand tools or power tools with HEPA vacuum dust collection attachments.

Notes

Inside of enclosure, use Level B work practices to minimize fiber release for procedures that involve drilling, cutting, abrading, sanding, chipping, breaking or sawing.

Do not use power tools inside glovebags.

Work Practice

1. Perform Pre-work activities on Level C checklist.
2. Tools, equipment and materials:
 - a. Tools as needed from the lists in General Procedure W1
 - b. Tools as needed
 - c. Pry bar
3. Complete Worker General Procedure W4 "Secure Work Area"
4. Put down drop sheet and complete Worker General Procedure W10 "Polyethylene Drop Cloth."
5. Erect mini-enclosure and set up negative pressure system and/or HEPA filtered local exhaust ventilation according to General Procedure W20 "Mini-Enclosure"
6. If back side of drywall is accessible, enclose and provide negative pressure for enclosure.
7. Place tools, equipment and materials needed into enclosure.
8. Enter enclosure and adequately wet area of drywall to be removed using garden sprayer with amended water.
9. Cut around perimeter of area to be removed using utility knife. Wet cutting area during cutting.
10. If drywall remains attached to studs or substrate, use pry bar to pull sheet out enough so edge can be gripped with hands. Mist cavity behind drywall, and back side of drywall to be removed with amended water.
11. Pull sheet out so sheet folds at fastener line or sheet is pulled away from fasteners. Adequately wet fold or holes from fasteners.

M16 . Level C... continued

12. Repeat steps above at other attachment points, remove drywall piece, and package for disposal.
13. Remove fasteners from studs or substrate and place into disposal bags. Clean any debris left on studs or substrate using amended water and nylon brush.
14. Pick up any debris and place into disposal bags. HEPA vacuum and wet wipe up any dust generated.
15. Perform maintenance work and clean-up and tear-down steps on Level C checklist to complete work.

M19 . Summary

Remove filters from HVAC unit

Summary

This work practice covers the procedures for removing filters in HVAC unit that may be contaminated with asbestos.

Examples

- Level B:** A. Remove prefabricated slip-in type filters from HVAC unit in mechanical room.
B. Replace filters in HVAC unit in mechanical room with roll-type filters.

Related Work Practices

Building Lock-Out Tag-Out program.

Worker Recommendations

One worker. A second worker may be needed for large, roll-type filters. A person with air monitoring training might be required. This person can be a worker.

M19 . Level B

Remove filters from HVAC unit

Example

The following are examples of work that can be performed using the procedures of this Level B work practice. If job conditions vary from the examples stop work and notify your supervisor.

- A. Remove prefabricated slip-in type filters with a heavy dust loading from HVAC unit in mechanical room.
 - B. Replace filters in HVAC unit in mechanical room with roll-type filters.
-

Notes

A Negative Exposure Assessment must have been made by a Competent Person before this work practice is used. If a negative exposure assessment (NEA) has not been made, stop work and notify your supervisor.

Turn off HVAC unit fan, tag, and lock-out switch in accordance with facility's Lock-Out Tag-Out program before performing this work practice.

Work Practice

1. Perform Pre-work activities on Level B checklist.
2. Tools, equipment and materials:
 - a. Tools as needed from the lists in General Procedure W1
 - b. Replacement filters.
3. Complete Worker General Procedure W4 "Secure Work Area." Verify that HVAC unit is shut off and locked out.
4. Put down drop sheet and complete Worker General Procedure W10 "Polyethylene Drop Cloth."
5. Place tools, equipment and materials needed in work area.
6. Wet filters with amended water. Wet sufficiently that filter is saturated, but water is not running from filter.
7. Put on disposable gloves. Remove filters from filter frame and place directly into disposal bag. Cut away exposed portions of roll type filters, and place directly into disposal bag.
8. After all filters are removed, take off gloves and dispose of with filters. Double bag waste, dispose of as ACM waste.
9. HEPA vacuum and wet wipe area where filters were installed and accessible surfaces in filter chamber.
10. Install new filters. For roll type filters, roll new filter material into place and cover filter material remaining on role with sheet plastic or filter cover.
11. Perform clean-up and tear-down steps on Level B checklist to complete work.

M20 . Summary

Clean up debris

Summary

This work practice describes the procedures to be used to clean debris and dust that has resulted from disturbance of an asbestos-containing material (ACM). The O&M program designer needs to define a "minor" release. This will depend on the material in a facility and the skill and training of the maintenance staff doing the clean-up work. The consequences of a material release will depend on the nature of the material and the event that caused the release. If a relatively non-friable material such as a ceiling tile were to fall out of a ceiling grid this would be a simple clean up that could probably be handled with Level A controls. If the material were a very soft and loosely consolidated acoustical material that was knocked loose by a basketball, the clean up will be more

extensive and would probably require Level B procedures. The O&M designer needs to define limits appropriate for the material and level of expertise of the maintenance staff doing the work. The O&M program also needs to deal with major fiber releases. In most cases it is best to have these clean-ups performed by an asbestos abatement contractor, unless the building staff has experience in asbestos abatement work practices and controls. Some regulations, such as AHERA, define maximum quantities for this activity. Regulations may also require that a fiber release report be prepared and made available to affected personnel. If fiber release needs Level C work practices, it should be treated as an abatement project, not as O&M work.

Examples

Level B: Level B procedures are appropriate where a small quantity of debris needs to be picked up, but dust in the space also needs to be removed as a potentially asbestos contaminated material. This could be required after the fallout of a small amount of material from a ceiling, pipe insulation or other source. If a large quantity of material is involved, then this section should be combined with cleaning of all surfaces in the room. It is usually easier and less expensive to simply remove the dust using asbestos control procedures, than it is to attempt to find out if it contains asbestos.

- A. Clean up debris and dust on surfaces after a small area of surfacing ACM has fallen from a ceiling, pipe insulation or other source.

Related Work Practices

- S 10 Repair damaged surfacing ACM.
- T 7 Repair damaged thermal system insulation on a boiler, duct or flue.
- M 25 Clean room that has asbestos-containing dust.

Worker Recommendations:

One worker. A person with air monitoring training might be required. This person can be the worker.

M20 . Level B

Clean up debris

Example

The following are examples of work that can be performed using the procedures of this Level B work practice. If job conditions vary from the examples stop work and notify your supervisor.

- A. Clean up debris and dust on surfaces after a small area of surfacing ACM has fallen from a ceiling, pipe insulation or other source.

Notes

A Negative Exposure Assessment must have been made by a Competent Person before this work practice is used. If a negative exposure assessment (NEA) has not been made, stop work and notify your supervisor.

This work practice is limited to the cleanup of a small quantity of relatively intact debris which has fallen from an architectural finish, fire-proofing, or thermal insulation on pipes, boilers or other equipment.

Coordinate work with proper O & M work practice to repair cause of fiber release.

Work Practice

1. Perform Pre-work activities on Level B checklist.
2. Tools, equipment and materials:
 - a. Tools as needed from the lists in General Procedure W1
3. Complete Worker General Procedure W4 "Secure Work Area"
4. Remove asbestos-containing debris using the following sequence:
 - a. Shut down all ventilation into room.
 - b. Start HEPA vacuum before entering the area.
 - c. Use the HEPA vacuum to clean a path at least 6 feet (1.83 m) wide from the entry point of the work area to the site of the fallen material.
 - d. Remove all small debris with the HEPA vacuum.
 - e. Remove any dust or loose debris from the surface of larger pieces of ACM with a HEPA vacuum. Mist surface of pieces with amended water.
 - f. Pick up such pieces and place in the bottom of a 6 mil (0.15 mm) polyethylene disposal bag conforming to the requirements of General Procedure W11 "Packaging and Labeling Waste." Place pieces in the bag without dropping and avoiding unnecessary disturbance and release of material. Thoroughly wet debris in bag with amended water as it is collected.
 - g. Remove all remaining visible debris with HEPA vacuum.<

M20 . Level B ... continued

- h. HEPA vacuum an area 3 feet (0.91 m) beyond the location in which any visible debris was found. HEPA in two directions each at right angles to the other using work procedures of work practice M1 "Cleaning Potentially Asbestos-Contaminated Carpet."
 - i. Wet wipe any hard surfaces or objects in the area using procedures of General Procedure W9 "Wet Wiping, HEPA Vacuuming and Steam Cleaning."
 - j. Place a 6 mil (0.15 mm) polyethylene drop cloth in accordance with General Procedure W10 "Polyethylene Drop Cloth," immediately on top of the HEPA vacuumed area before performing any repair work on site from which fall-out occurred.
 - k. HEPA vacuum the site from which material fell removing all loose material which can be removed by the vacuums suction.
 - l. Repair or remove remaining material using the appropriate O&M work practice.
 - m. HEPA vacuum ladder and/or any tools used and pass out of the work area.
5. Clean and decontaminate objects in the vicinity of debris using the following procedure:
- a. Perform all work of decontaminating objects wherever possible on a plastic drop sheet installed in conformance General Procedure W10 "Polyethylene Drop Cloth."
 - b. HEPA vacuum all surfaces of object and immediate area before moving the object.
 - c. Pick-up object, if possible, and HEPA vacuum all surfaces.
 - d. Hand to off-sheet worker who will wet-clean object, if possible, and place in storage location.
 - e. Decontaminate area where object was located by HEPA vacuuming twice, in two perpendicular directions. Wet clean if necessary to remove any debris.
 - f. Return object to its original location.
6. Perform clean-up and tear-down steps on Level B checklist to complete work.

M21 . Summary

Replace asbestos-containing gaskets/packing

Summary

This work practice describes the work required to replace ACM gaskets or ACM valve packing for O&M work. These could be applied to work on small simple gaskets in a school or office building, or highly developed and specialized gaskets in industrial applications..

The asbestos in gaskets and packing can range from simple asbestos felt or rope to composites of cement, rubber, graphite, metal or other materials.

The temperature, pressure and corrosiveness of the pipe fill, clamping pressure, composition of the gasket and packing all affect the ease of maintenance tasks. The size and composition of the gasket or packing, its condition and the extent to which it is adhered are the major determinants of potential airborne fiber levels. The more damaged the gasket or packing (e.g. by a corrosive pipe fill), the more it is adhered to the flange or valve, the greater the potential for release of debris and airborne asbestos. The O&M designer should make separate exposure assessments for different anticipated levels of difficulty of maintenance work on gaskets or packing. This means, for example, all of the low temperature, low pressure piping with a particular type of gasket could be considered as a group. During design of the O&M, an assignment of an O&M level and specific work practices could reasonably be made for each piping system for removal of gaskets and packings. This activity can be integrated with other regulatory compliance activities such as those required by OSHA for process safety management. The asbestos control requirements could be indicated on the P&ID for various systems.

OSHA sets forth specific Class II work requirements for gasket removal in 29 CFR 1926.1101(g)(8)(iv)

- If a gasket is visibly deteriorated and unlikely to be removed intact, removal shall be undertaken within a glovebag...
- The gasket shall be thoroughly wetted with amended water prior to its removal.
- The wet gasket shall be immediately placed in a disposal container.
- Any scraping to remove residue must be performed wet

These C requirements should work well on a small piping system for water or steam that can be worked on cold such as might be found in a school or office building. In an industrial setting these procedures may be infeasible for some circumstances. Glovebag use is not feasible on hot or large pipes, and is dangerous when power tools (such as a wire brush on a drill) are used. Wetting is not feasible on hot or freezing piping, or where water is incompatible with the pipe fill. Usually, airborne fiber levels during gasket or packing removals can be kept below the OSHA PEL by use of wetting (where feasible), careful handling and the use of HEPA vacuums for material collection and local exhaust ventilation. Fortunately, OSHA allows some flexibility in complying with the regulation. There are two possible alternative courses the O&M designer can take to comply with OSHA.

Class II: OSHA allows the use of "Alternative Work Practices and Controls" as long as worker exposures will not exceed the PELs. The OSHA regulation 29 CFR 1926.1101(g)(8)(vi)

M21 . Summary ... continued

requires that “the different or modified controls reduce direct and indirect employee exposure to below the PELs under all expected conditions of use and that the method meets the requirements of this [sic. the OSHA] standard.” for details. The controls developed by the O&M designer must reliably keep airborne fiber levels below the PELs. The work area where these controls are to be applied must be evaluated by a competent person.

Class III: OSHA allows Class II work that removes no more material than will fit in a 60" disposal bag to be classified as Class III work. Class III work can be performed without enclosure as long as a Negative Exposure Assessment (NEA) is made. Refer to the introduction for more information on making an NEA.

In either instance the O&M designer is allowed to develop work practices for the removal of gaskets and packings that are practical for a specific application and that comply with OSHA requirements. However, unless Class II (glovebag) procedures are followed, the O&M designer has the burden of demonstrating that the procedures are effective in controlling worker exposures to below the PELs.

NOTE: Removal of a gasket or packing frequently involves the removal of thermal system insulation. O&M procedures for TSI removal are described in Section V of this manual. The O&M designer should coordinate the work practices of this section with the TSI removal work practices.

Examples

Work practices for the following situations are provided as examples. They should be edited as required for the particular conditions in a facility.

WARNING: These work practices include “Alternative Work Practices and Controls.” The O&M program designer must be a competent person as defined by OSHA, and must make an evaluation that PELs will not be exceeded during use of the work practices, or must make a Negative Exposure Assessment (NEA) for work conducted using these work practices.

Level A: The example work practice is for a situation where the gasket/packing comes out in one piece, and no residue needs to be removed. This could cover a great proportion of non-industrial cases. The O&M designer will need to determine if this work practice applied to a packing which unwinds from around a valve stem, but comes out in one piece.

A. Remove and replace non-adhered gasket/packing that can be removed intact.

Level B: This work practice is an example of a site specific work practice that can be developed for removal of gaskets/packing that is damaged or adhered to its seat. During design of the work practice the O&M designer (who must be a competent person) needs to either make the determination that airborne fiber levels during the use of the work practice will not exceed the OSHA PELs required for an alternative Class II work practice, or needs to make an NEA. To meet Class II requirements the designer must certify in writing that use of the work practice will, “reduce direct and indirect employee exposure to below the

M21 . Summary ... continued

PELs under all expected conditions of use," and that the work practice meets the requirements of the OSHA standard. Each time that work is assigned the asbestos program manager (APM) must evaluate the work area and make a determination that conditions at the specific job site are equivalent to those that existing during development of the work practice, so that the work practice is applicable. The need for Level B work practices that are site specific will usually be greater on industrial sites, locations where workers will frequently be working on gaskets, and where pipes are hot, cold or filled with a material incompatible with water. The example work procedure is based on wet methods. If water cannot be used, then the work practice will rely more on careful work practices, and local exhaust ventilation. If work on gaskets/packing is an infrequent event, it may be simpler to follow the OSHA glovebag procedure than to develop a site specific procedure:

- A. Remove and replace gasket/packing that is damaged or adhered to the gasket seat.

Level C: OSHA requires that a glovebag procedure be used unless a site specific alternative procedure is developed. Glovebags are a Level C procedure. This example contains three alternatives: the OSHA glovebag, a mini-enclosure, and a site specific local ventilation procedure.

- A. Remove and Replace a pipe flange gasket where power tools are required to remove residue of old gasket/packing.
- B. Remove and replace a large friable door hatch gasket that is in poor condition, or other large gaskets in poor condition.

Related Work Practices

- T 1 Remove insulation on exposed pipe for maintenance work.
- T 3 Remove insulation on exposed pipe in elevated location for maintenance work.
- T 6 Repair damaged thermal system insulation on a boiler, duct or flue.

Worker Recommendations

One worker for Level A and Level B. Two workers for Level C. A person with air monitoring training might be required. This person can be the worker.

M21 . Level A

Replace asbestos-containing gaskets/packing

Example

The following are examples of work that can be performed using the procedures of this Level A work practice. If job conditions vary from the examples stop work and notify your supervisor.

- A. Remove and replace non-adhered gasket/packing that can be removed intact.
-

Notes

A Negative Exposure Assessment must have been made by a Competent Person before this work practice is used. Verify that a negative exposure assessment (NEA) has been made. If an NEA cannot be verified, stop work and notify your supervisor.

If asbestos-containing thermal system insulation must be removed to permit access for gasket/packing replacement, use the appropriate work practice from Section V "Thermal Systems Insulation (TSI) Work Practices," of this manual. Complete the Section V work practice before starting the work of this section.

Work Practice

1. Perform Pre-work activities on Level A checklist.
2. Tools, equipment and materials:
 - a. Tools as needed from the lists in General Procedure W1
 - b. Tools required to access gasket
 - c. Replacement materials
3. Complete Worker General Procedure W4 "Secure Work Area"
4. Place tools, equipment and materials needed in work area.
5. Disassemble equipment as needed to expose entire gasket.
6. Remove gasket and place into disposal bag. Wet-wipe flange where gasket was installed.
7. Install new gasket and reassemble equipment
8. Perform applicable steps on Level A checklist to complete work.

M21 . Level B

Replace asbestos-containing gaskets/packing

Example

The following are examples of work that can be performed using the procedures of this Level B work practice. If job conditions vary from the examples stop work and notify your supervisor.

- A. Remove and replace gasket/packing that is damaged or adhered to the gasket seat.
-

Notes

A Negative Exposure Assessment must have been made by a Competent Person before this work practice is used. If a negative exposure assessment (NEA) has not been made, stop work and notify your supervisor.

If asbestos-containing thermal system insulation must be removed to permit access for gasket/packing replacement, use the appropriate work practice from Section V "Thermal Systems Insulation (TSI) Work Practices," of this manual. Complete the Section V work practice before starting the work of this section.

If active electrical equipment is in work area, do not wet equipment, stop work, notify your supervisor.

Work Practice

1. Perform Pre-work activities on Level B checklist.
2. Tools, equipment and materials:
 - a. Tools as needed from the lists in General Procedure W1
 - b. Tools required to access and work remove gasket or packing
 - c. Replacement materials
3. Complete Worker General Procedure W4 "Secure Work Area"
4. Prepare work area with drop cloth and complete Worker General Procedure W10 "Polyethylene Drop Cloth."
5. Place tools, equipment and materials needed into work area.
6. If pipe is hot or cold put on protective equipment as required.
7. Remove thermal system insulation (TSI) as necessary using procedures from Section V "Thermal Systems Insulation (TSI) Work Practices," of this manual.
8. Disassemble equipment as needed to expose entire gasket/packing.
9. Remove gasket/packing using the following procedures:
 - a. Use this procedure if a negative exposure assessment (NEA) has been made. If you do not know if an NEA has been made, stop work, and notify your supervisor.

M21 . Level B ... continued

- b. Wet gasket with amended water. If wetting is not practical due to temperature of pipe or nature of pipe fill, stop work, and notify your supervisor
 - c. Use careful handling and local exhaust ventilation with a HEPA vacuum to remove the gasket/packing. .
 - d. Carefully scrape gasket from seat while holding nozzle of HEPA vacuum in proximity to the flange or packing box. Immediately place pieces of gasket in disposal bag. Try to remove gasket in as few pieces as possible.
 - e. Promptly pick up any debris with a HEPA vacuum
 - f. Clean residue from surface of seat using wet methods. Keep work site continuously wet.
 - g. If power tools are needed to remove residue of old gasket/packing, stop work, and notify your supervisor. Level C work practices are to be used for this type of work.
 - h. HEPA vacuum and wet wipe surfaces to which gasket was attached.
10. Install new gasket/packing and reassemble equipment.
11. Perform clean-up and tear-down steps on Level B checklist to complete work.

M21 . Level C

Replace asbestos-containing gaskets/packing

Example

The following are examples of work that can be performed using the procedures of this Level C work practice. If job conditions vary from the examples stop work and notify your supervisor.

- A. Remove and Replace a pipe flange gasket where power tools are required to remove residue of old gasket/packing.
 - B. Remove and replace a large friable door hatch gasket that is in poor condition, or other large gaskets in poor condition.
-

Notes

If asbestos-containing thermal system insulation must be removed to permit access for gasket/packing replacement, use the appropriate work practice from Section V "Thermal Systems Insulation (TSI) Work Practices," of this manual. Complete the Section V work practice before starting the work of this section.

Work Practice

1. Perform Pre-work activities on Level C checklist.
2. Tools, equipment and materials:
 - a. Tools as needed from the lists in General Procedure W1
 - b. Tools required to access and work on remove gasket or packing
 - c. Replacement materials
 - d. Glovebag (if required)
3. Complete Worker General Procedure W4 "Secure Work Area"
4. Put down drop sheet and complete Worker General Procedure W10 "Polyethylene Drop Cloth."
5. Use one of the following procedures to remove gasket/packing:
 - a. Perform work inside a glovebag. If use of a glovebag is not feasible or dangerous, the pipe is over 150°F., or if entire gasket/packing will not fit in a glovebag, stop work and notify your supervisor. Adequately wet gasket and remove gasket and debris using glovebag procedures. See General Procedure W18 "Glovebag Removal." DO NOT USE POWER TOOLS INSIDE OF A GLOVEBAG. If scrubbing pads and nylon/wire brushes will not completely remove residue of old gasket/packing, stop work, and notify your supervisor.
 - b. Perform work inside a mini-enclosure:
 - i. Erect mini-enclosure and set up negative pressure system and/or HEPA filtered local exhaust ventilation according to General Procedure W20 "Mini-Enclosure"
 - ii. Place tools, equipment and materials needed into enclosure.

M21 . Level C ... continued

- iii. Enter enclosure and disassemble equipment as needed to expose entire gasket/packing.
 - iv. Wet gasket with amended water. If wetting is not practical due to temperature of pipe or nature of pipe fill, stop work, and notify your supervisor.
 - v. Use careful handling and local exhaust ventilation with a HEPA vacuum to remove the gasket/packing.
 - vi. Carefully scrape gasket from seat while holding nozzle of HEPA vacuum in proximity to the flange or packing box. Immediately place pieces of gasket in disposal bag. Try to remove gasket in as few pieces as possible.
 - vii. Promptly pick up any debris with a HEPA vacuum.
 - viii. Clean residue from surface of seat using wet methods. Keep work site continuously wet.
 - ix. If power tools are needed to remove residue of old gasket/packing, use local exhaust ventilation as described below.
 - x. HEPA vacuum and wet wipe surfaces to which gasket was attached.
- c. Local Exhaust Ventilation: If power tools (wire brush on a drill) are needed to remove residue of old gasket/packing use the following procedure. **DO NOT ATTEMPT TO USE THIS PROCEDURE INSIDE OF A GLOVEBAG.**
- i. Attach a manufactured or job-built collection attachment to nozzle of HEPA vacuum that is large enough to capture material coming from operating wire brush.
 - ii. Install plastic drop cloth behind HEPA vacuum collection attachment.
 - iii. Wet residue with amended water.
 - iv. Remove residue with wire brush. Direct stream of removed material into HEPA vacuum attachment.
 - v. Wet wipe and HEPA inside of attachment and surfaces from which residue was removed.
- 6. HEPA vacuum and/or wet wipe surfaces to which gasket was attached.
 - 7. Install new gasket, reassemble equipment and perform maintenance work required.
 - 8. Clean-up and tear-down steps on Level C checklist to complete work.

M22 . Summary

Emptying and changing filter in HEPA vacuum or changing filter in HEPA fan unit

Summary

This work practice covers the procedures for changing the bag, filter and/or cleaning a HEPA vacuum, or changing the filter in a HEPA filtered fan unit. The manufacturers of HEPA vacuums publish work procedures for emptying and maintenance. The manufacturer's recommendations for the particular equipment in use at the facility should be reviewed by the O&M designer and used as the basis for revision of these work practices.

Examples

- Level B:**
- A. Empty HEPA vacuum bag using localized engineering controls.
 - B. Change filter in HEPA fan unit.
 - C. Change filter or bag in HEPA vacuum using a glovebag.

- Level C:**
- A. Empty bag, change filter and clean HEPA vacuum.
 - B. Change filter in a HEPA fan unit in a mini-enclosure.
-

Related Work Practices

None

Worker Recommendations

One worker for Level B. Two workers for Level C. A person with air monitoring training might be required. This person can be the worker.

M22 . Level B

Emptying and changing filter in HEPA vacuum or changing filter in HEPA fan unit

Example

The following are examples of work that can be performed using the procedures of this Level B work practice. If job conditions vary from the examples stop work and notify your supervisor.

- A. Empty HEPA vacuum bag using localized engineering controls.
- B. Change filter in HEPA fan unit.
- C. Change filter or bag in HEPA vacuum using a glovebag.

Notes

A Negative Exposure Assessment must have been made by a Competent Person before this work practice is used. If a negative exposure assessment (NEA) has not been made, stop work and notify your supervisor.

Work Practice

1. Perform Pre-work activities on Level B checklist.
2. Tools, equipment and materials:
 - a. Tools as needed from the lists in General Procedure W1
 - b. Manufacturer's instructions for unit having filter or bag replaced
 - c. Tools as needed to remove filter or bag
 - d. Replacement filters or bags
 - e. Glovebag and hand operated spray bottle
3. Complete Worker General Procedure W4 "Secure Work Area"
4. Put down drop sheet and complete Worker General Procedure W10 "Polyethylene Drop Cloth."
5. Place tools, equipment and materials needed onto drop cloth, including HEPA vacuum or fan unit with filter or bag to be changed. If available, include an operable HEPA vacuum for cleaning up any dust or debris from the filter change operation.
6. Use one of the following procedures for changing filter bag
 - a. Use Glovebag to change filter or bag:
 - i. Insert new bag or filter, wet wiping cloths, and a hand-operated spray bottle into glovebag.
 - ii. Seal glovebag to unit to permit access to filter or bag inside glovebag.
 - iii. Open unit and adequately wet filter or bag. Remove filter or bag and place in corner of glovebag. Wet wipe inside of unit.
 - iv. Install new filter or bag. Close unit and wet wipe inside of glovebag. Put wet wipes in corner of glovebag.

M22 . Level B ... continued

- v. Twist, and tape glovebag to seal bag/filter/rags from spray bottle.
- vi. Cut and remove glovebag from unit. Place glovebag into a disposal bag.
- b. Change filter or bag using the manufacturer's recommended work practice and the following:
 - i. Carefully disassemble unit as needed to access filter and/or bag.
 - ii. Adequately wet filter and/or bag, remove from unit and place into disposal bag.
 - iii. Using operable HEPA vacuum or wet wiping, clean area where filter or bag was installed.
- 7. Install new filter and/or bag in unit, reassemble unit and
- 8. Perform clean-up and tear-down steps on Level B checklist to complete work.

M22 . Level C

Emptying and changing filter in HEPA vacuum or changing filter in HEPA fan unit

Example

The following are examples of work that can be performed using the procedures of this Level C work practice. If job conditions vary from the examples stop work and notify your supervisor.

- A. Empty bag, change filter and clean HEPA vacuum.
- B. Change filter in HEPA fan unit in a mini-enclosure.

Notes

This procedure may be performed in an existing mini-enclosure, if available.

Work Practice

1. Perform Pre-work activities on Level C checklist.
2. Tools, equipment and materials:
 - a. Tools as needed from the lists in General Procedure W1
 - b. Manufacturer's instructions for unit having filter or bag replaced
 - c. Tools as needed to remove filter or bag
 - d. Replacement filters or bags
3. Complete Worker General Procedure W4 "Secure Work Area"
4. Put down drop sheet and complete Worker General Procedure W10 "Polyethylene Drop Cloth."
5. Erect mini-enclosure and set up negative pressure system and/or HEPA filtered local exhaust ventilation according to General Procedure W20 "Mini-Enclosure"
6. Place tools, equipment and materials needed into enclosure, including HEPA vacuum or fan unit with filter or bag to be changed.
7. Enter enclosure and carefully disassemble unit as needed to access filter or bag. Adequately wet filter and/or bag, remove from unit and place into disposal bag.
8. Adequately wet any remaining debris. Pick up debris or empty debris into a disposal bag.
9. Using operable HEPA vacuum or wet wiping, clean area where filter or bag was installed.
10. Install new filter and/or bag in unit, reassemble unit and
11. Perform clean-up and tear-down steps on Level C checklist to complete work.

M24 . Summary

Remove asbestos-containing caulking/glazing compound

Summary

This work practice describes the procedures for removing small amounts of asbestos-containing caulking compound as required for maintenance or repair work.

Examples

Level A: A. Remove a small amount of pliable caulking compound. No sanding will be performed.

Level B: A. Reglaze several small window panes. No sanding will be performed.
B. Remove small amount of dry caulking compound.

Level C: A. Reglaze an entire window or several windows.

Related Work Practices

None

Worker Recommendations

One worker for Level A and Level B. Two workers for Level C. A person with air monitoring training might be required. This person can be the worker.

M24 . Level A

Remove asbestos-containing caulking/glazing compound

Example

The following are examples of work that can be performed using the procedures of this Level A work practice. If job conditions vary from the examples stop work and notify your supervisor.

- A. Remove a small amount of pliable caulking compound. No sanding will be performed.

Notes

This work practice must be used in conjunction with General Procedure W1 and a Level A Worker Checklist. The worker checklist includes tasks that must be performed before these work practices are begun.

A Negative Exposure Assessment must have been made by a Competent Person before this work practice is used. Verify that a negative exposure assessment (NEA) has been made. If an NEA cannot be verified, stop work and notify your supervisor.

Work Practice

1. Perform Pre-work activities on Level A checklist.
2. Tools, equipment and materials:
 - a. Tools as needed from the lists in General Procedure W1
 - b. Scraper 2-3" (50-75 mm) wide stiff blade
3. Complete Worker General Procedure W4 "Secure Work Area"
4. Place tools, equipment and materials needed in work area.
5. Using utility knife or edge of scraper, cut away caulking and place into disposal bags.
6. Remove any residual caulking using scraper and knife and place caulking into disposal bags.
7. HEPA vacuum and/or wet wipe areas where caulking was removed. Use Work Practice M22 if HEPA vacuum needs maintenance, or if bag or filter needs to be replaced.
8. Perform maintenance work and
9. Perform clean-up and tear-down steps on Level A checklist to complete work.

M24 . Level B

Remove asbestos-containing caulking/glazing compound

Example

The following are examples of work that can be performed using the procedures of this Level B work practice. If job conditions vary from the examples stop work and notify your supervisor.

- A. Reglaze several small window panes. No sanding will be performed.
- B. Remove small amount of dry caulking compound.

Notes

A Negative Exposure Assessment must have been made by a Competent Person before this work practice is used. If a negative exposure assessment (NEA) has not been made, stop work and notify your supervisor.

Work Practice

1. Perform Pre-work activities on Level B checklist.
2. Tools, equipment and materials:
 - a. Tools as needed from the lists in General Procedure W1
 - b. Scraper 2-3" (50-75 mm) wide stiff blade
 - c. Stiff nylon bristle brushes
3. Complete Worker General Procedure W4 "Secure Work Area"
4. Put down drop sheet and complete Worker General Procedure W10 "Polyethylene Drop Cloth."
5. Place tools, equipment and materials needed onto drop cloth.
6. Enter work area and adequately wet caulking to be removed using garden sprayer with amended water.
7. Using utility knife or edge of scraper, cut away caulking and place into disposal bags.
8. Remove any residual caulking using scraper, knife and nylon brushes and place caulking into disposal bags.
9. HEPA vacuum and wet wipe areas where caulking was removed.
10. Perform maintenance work and clean-up and tear-down steps on Level B checklist to complete work.

M24 . Level C

Remove asbestos-containing caulking/glazing compound

Example

The following are examples of work that can be performed using the procedures of this Level C work practice. If job conditions vary from the examples stop work and notify your supervisor.

- A. Reglaze an entire window or several windows

Notes

This work practice must be used in conjunction with General Procedures W1, W10 and a Level C Worker Checklist. The worker checklist includes tasks that must be performed before these work practices are begun.

Work Practice

1. Perform Pre-work activities on Level C checklist.
2. Tools, equipment and materials:
 - a. Tools as needed from the lists in General Procedure W1
 - b. Scraper (2-3" wide stiff blade)
 - c. Stiff nylon bristle brushes
3. Complete Worker General Procedure W4 "Secure Work Area"
4. Put down drop sheet and complete Worker General Procedure W10 "Polyethylene Drop Cloth."
5. Erect mini-enclosure and set up negative pressure system and/or HEPA filtered local exhaust ventilation on side of window with exposed caulking compound according to General Procedure W20 "Mini-Enclosure"
6. Place tools, equipment and materials needed into enclosure.
7. Enter enclosure and adequately wet caulking to be removed using garden sprayer with amended water.
8. Using utility knife or edge of scraper, cut away caulking and place into disposal bags.
9. Remove any residual caulking using scraper, knife and nylon brushes and place caulking into disposal bags.
10. HEPA vacuum and wet wipe areas where caulking was removed.
11. Perform maintenance work and clean-up and tear-down steps on Level C checklist to complete work.

M25 . Summary

Clean room that has asbestos-containing dust

Summary

This work practice should be used for routine or special cleaning in rooms where asbestos-containing dust is present, or is assumed to be present. This is useful in situations where an ACM may be periodically disturbed (e.g. a soft acoustical finish in reach of occupants). This work practice augments normal cleaning practice by adding HEPA vacuums and wet methods. It is intended

to substitute for normal cleaning practices in locations where there could be a periodic minor disturbance of an ACM. Cleaning with HEPA vacuums, wet methods and dust removal methods prevents the accumulation of asbestos in the dust. The practices include the cleaning of furniture, fixtures, and other surfaces.

Examples

- Level A:**
- A. Clean an office area where asbestos-containing dust may settle on furniture due to periodic disturbance of an exposed ACM.
 - B. Clean a mechanical room where dust is assumed to contain ACM from thermal systems insulation present in room.

Related Work Practices

- S 9 Clean room with exposed surfaces finished with ACM
- R 5 Wet strip floor wax from resilient asbestos flooring
- R 6 Dry or spray buffing resilient asbestos flooring
- R 7 Cleaning resilient asbestos flooring
- M 20 Clean up debris from minor release

Worker Recommendations

One worker trained in special cleaning procedures. A person with air monitoring training might be required. This person can be the worker.

M25 . Level A

Clean room that has asbestos-containing dust

Example

The following are examples of work that can be performed using the procedures of this Level A work practice. If job conditions vary from the examples stop work and notify your supervisor.

- A. Clean an office area where asbestos-containing dust may settle on the floor, furniture and horizontal surfaces due to periodic disturbance of an exposed ACM.
- B. Clean a mechanical room where dust is assumed to contain ACM from thermal systems insulation present in room.

Notes

A Negative Exposure Assessment must have been made by a Competent Person before this work practice is used. Verify that a negative exposure assessment (NEA) has been made. If an NEA cannot be verified, stop work and notify your supervisor.

This work procedure is intended for routine or periodic cleaning of a space. If you discover visible dust or debris, or a fallout of ACM, stop work, and notify your supervisor.

Work Practice

1. Perform Pre-work activities on Level A checklist.
2. Tools, equipment and materials:
 - a. Tools as needed from the lists in General Procedure W1
 - b. Dusting materials (cloths, dusters, mops) that are damp or are treated with catatonic or anti-static dust attractant preparations.
 - c. Furniture polish
3. Routine dusting: Using damp or treated dusting materials, clean surfaces beginning from the top of the room and working towards the floor. Do not dry dust. HEPA vacuum surfaces that are not easily cleaned with dusting materials.
4. Routine vacuuming: Perform routine vacuuming with HEPA vacuums. HEPA vacuum surfaces such as drapes and fabric covered surfaces by starting at the top and working towards floor. HEPA vacuum carpet as last step after all dusting. Use Work Practice M22 "Emptying and changing Filter in HEPA Vacuum" if HEPA vacuum needs maintenance, or if bag or filter needs to be replaced.
5. Routine floor cleaning: Dust mop using damp mops or treated dusting mops. Wash floors using normal mopping procedures. HEPA vacuum carpeting. Maintain resilient flooring using work practices R5, R6 and R7. Do not dry dust. Do not use vacuum a vacuum cleaner without a HEPA filter.

M25 . Level A ... continued

6. Periodic cleaning: Surfaces that are not routinely cleaned are to be cleaned during periodic cleaning using wet methods or HEPA vacuums. Wet wipe smooth hard surfaces (such as blinds) or wash with paper towels or disposable cloths using work practices of General Procedure W9 "Wet Wiping, HEPA Vacuuming and Steam Cleaning." HEPA vacuum cloth or textured surfaces. Dispose of all dirty cloths and soiled dusting materials while still damp in ACM disposal bags.
7. Apply new polish where needed using standard procedures.
8. Perform clean-up and tear-down steps on Level A checklist to complete work.

VII. Resilient Flooring

Work Practices



Figure 11: Resilient Flooring Location Illustration

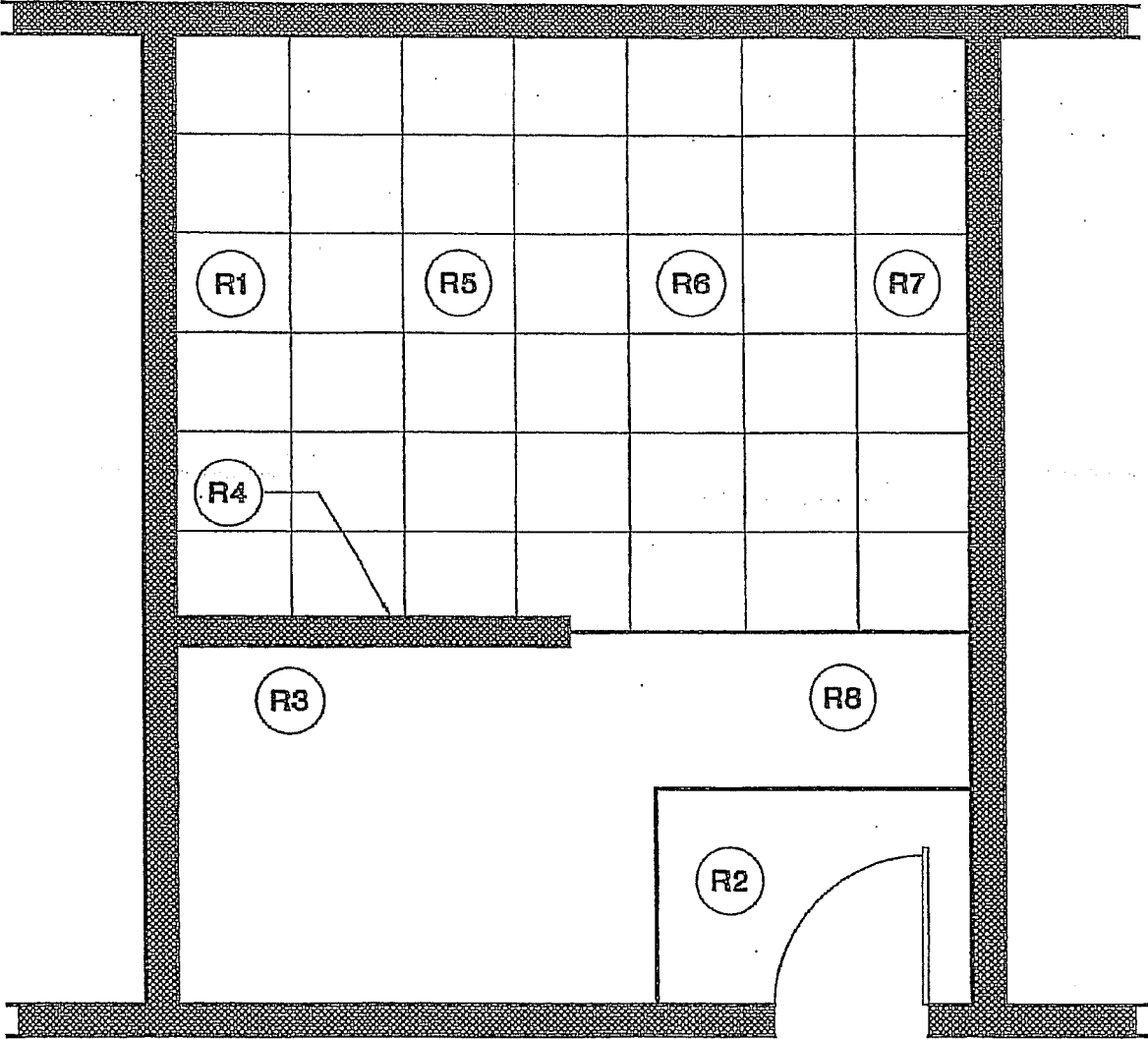

Section VII. Resilient Flooring Work Practices

Resilient Flooring Location Illustration		348	
<i>Code Levels Description</i>			
R1	A B+	Removal of resilient asbestos floor tiles	360
R2	A B+	Replacement of vinyl sheet flooring with ACM backing	370
R3	A	Install new resilient flooring or carpet over resilient asbestos flooring	377
R4	A B+	Install partition over resilient asbestos flooring	379
R5	A	Wet strip floor wax from resilient asbestos flooring	382
R6	A	Dry or spray buffing resilient asbestos flooring	385
R7	A	Cleaning resilient asbestos flooring	388
R8	A B+	Remove carpet over resilient asbestos flooring	391

The accompanying diagram illustrates typical applications of the above work practices.

GENERAL NOTES

Work Practice Levels The levels for each work practice included in this section are defined principally in relation to the OSHA asbestos standards. There are two standards that may apply. The OSHA construction standard, 29 CFR 1926.1101, applies to most O&M activities that involve removal of resilient flooring. Normal cleaning, and buffing of resilient flooring that is not associated with construction or other O&M work is covered by the OSHA general industry standard, 29 CFR 1910.1001. When maintenance and custodial activities are incidental to construction this work is Class IV under the construction standard, 1026.1101.

In general, an O&M program is easier to implement and is more cost effective if maintenance work can be performed without the need for enclosures. Maintenance work that

contacts or disturbs asbestos-containing materials (ACM) is governed by OSHA. To be able to perform maintenance work governed by the Construction Standard (1926.1101) without an enclosure and still comply with OSHA, it is necessary to make a negative exposure assessment. This effectively makes the OSHA PEL a limit on the level of airborne asbestos that can be generated by a work practice before enclosure is required. In general, Level A and B+ maintenance work practices are unenclosed and as such require a negative exposure assessment.

The two work practice levels in this section are defined as follows:

Level A: is Class II work with a negative exposure assessment that involves removal or repair of resilient floor covering materials. It also encompasses certain housekeeping operations, such as cleaning, buffing or

polishing of resilient flooring, governed by the general industry standard, 29 CFR 1910.1001, where initial monitoring is required for such work unless: (1) a determination has been made that these activities using the work practices in this manual (which are based on those contained in the OSHA regulations) are not reasonably expected to result in exposures exceeding the PEL; (2) the employer has monitored after March 31, 1992 for the TWA permissible exposure limit and/or excursion limit and the monitoring satisfies the requirements of 1910.1001(d); or (3) the employer has relied on objective data (see pg. 4-8 for explanation of objective data). In addition, housekeeping operations performed incidental to construction work are governed by the construction standard, 29 CFR 1926.1101(l), and are also within Level A when an NEA has been made in accordance with paragraph 1926.1101(f)(2).

Level B+: Level B+ is removal of resilient flooring materials that are not intact, or will become non-intact during removal, or where a negative exposure assessment cannot be made. Augmented Level B+ work practices can be used for work on resilient flooring where flooring materials become friable, if the OSHA PEL is not exceeded and release of ACM, dust and debris is confined to the immediate location of the disturbance. To comply with OSHA, Level B+ work practices used for this purpose require the addition of critical barriers to the respiratory protection, air monitoring and other work practices normally associated with Level B work. If more than a small quantity of material is disturbed during the work, then the activity exceeds the limitation of the work practices in this manual. Refer to the NIBS manual *Model Guide Specifications, Asbestos Abatement and Management in Buildings* for more information.

USING THE RESILIENT FLOOR COVERING MANUFACTURER'S RECOMMENDED WORK PRACTICES FOR THE REMOVAL OF RESILIENT FLOORING

The Resilient Floor Covering Institute (RFCI) and Armstrong World Industries (hereinafter referred to as the Resilient Floor Covering Manufacturers) have developed work practices that apply to the removal of asbestos and non-asbestos-containing resilient floor covering materials. Some of the Level A work procedures

in this section are based on those work practices. Work procedures that incorporate the RFCM procedures are noted as (RFCM Procedures).

OSHA revised its asbestos standard, in August of 1994. Resilient flooring manufacturers filed petitions for judicial review of parts of the standard.

A settlement agreement resolving these petitions was reached with OSHA on June 15, 1995 before a court decision was rendered. This "Settlement Agreement" is included in Appendix D to the OSHA Compliance Directive that relates to the new OSHA standard (CPL 2-2.63, November 3, 1995, Inspection Procedures for Occupational Exposure to Asbestos Final Rule 29 CFR Parts 1910.1001, 1926.1101, and 1915.1001). The O&M designer and asbestos program manager should acquire a copy of the OSHA Compliance Directive from the local OSHA office and review it during the development of facility specific work procedures for resilient flooring.

The EPA NESHAP regulation (40 CFR Part 61, Subpart M) addresses the handling and disposal of ACM during renovation and demolition of buildings. The position of the EPA on resilient flooring was clarified in the November 1990 revision of the NESHAP regulation. Asbestos-containing resilient floor products are defined by this regulation as a Category I nonfriable material, which is not regulated by the NESHAP unless it becomes friable or is subjected to sanding, grinding, cutting or abrading. Cutting in this instance includes sawing, but not shearing, slicing or punching. The EPA has determined that resilient flooring materials that have not been made friable before or during the work do not need to be disposed of as asbestos waste.

Any work procedures used must, at a minimum, meet the requirements of the OSHA and NESHAP regulations. This introduction describes the steps necessary to insure that O&M activities using the Manufacturers' Recommended Work Practices will be in compliance with these regulations. The O&M designer and APM should realize that state or local regulations may have requirements that differ from federal regulations and some may be more stringent. The work procedures in this section may have to be modified to comply with state or local regulations.

OSHA: During development of the OSHA regulation exposure data for workers involved in removal of resilient flooring was submitted. In the Settlement Agreement with the flooring manufacturers, OSHA agreed that data submitted during the rulemaking shows that removal of asbestos-containing resilient flooring material consistently results in worker exposures below the PEL (both the TWA and excursion limit), as long as certain work practices are followed. These work practices are referred to as "compliant work practices." OSHA has determined that a data set called the "Environ Data" is an example of this sort of exposure data, and that work practices recommended by the resilient floor covering manufacturers is an example of compliant work practices. This means that the Environ Data can be used as the basis for a "Negative Exposure Assessment" as long as the "Recommended Work

Practices” are used, and the material remains “intact” throughout the removal process. If a negative exposure assessment is made OSHA does not require that the work area be enclosed or that workers wear respirators or other asbestos specific protective clothing. Some of the Level A work procedures in this section are based on the manufacturers’ “Recommended Work Practices.”

During design of the O&M program, the O&M designer needs to make a determination that a negative exposure assessment (NEA) is feasible for O&M work involving removal of resilient flooring using the Recommended Work Practices. This should be done before this work is permitted under the O&M program as a Level A activity. An administrative framework should be established to ensure that a negative exposure assessment is made and documented for each resilient flooring project. This can be accomplished by making the APM responsible for the NEA. This is appropriate if the workers are directly supervised by the APM, and the APM is acting on behalf of the building owner or property manager who employs the workers. In this instance the APM **must** be a competent person as required by OSHA for work on intact resilient flooring. The APM should evaluate each O&M project to insure OSHA compliance before issuing a work order. This can be documented by having the APM complete the job form from “Using Compliant Work Practices to Remove Resilient Floor

Covering” (see Appendix E) published by the Resilient Floor Covering Institute (RFCI) and Armstrong World Industries, Inc. This form should be signed by the APM as the Competent Person making the negative exposure assessment. The designer needs to decide if any additional procedures need to be added to comply with the owner’s goals for the O&M program. If O&M work on resilient flooring is going to be contracted out refer to the *NIBS Model Guide Specification, Asbestos Abatement and Management in Buildings* for more information.

There are several steps necessary to insure OSHA compliance when using the recommended work practices for O&M work. These must be accomplished by the APM to insure OSHA compliance.

- **A negative exposure assessment must be made by the competent person.** The OSHA asbestos rulemaking record contains many measurements, collected under a variety of worksite conditions, showing worker exposures during removals of asbestos-containing “flooring material” (floor tile, sheet vinyl floor covering and flooring adhesive). As part of the Settlement Agreement, OSHA has agreed that these data show that use of Compliant Work Practices during removal of intact flooring material consistently result in worker exposures below the TWA and Excursion Limit established by the revised OSHA standard. As

such, before removal begins a Competent Person trained under requirements set forth in the Settlement Agreement may assess the job and make a negative exposure assessment when:

- **Compliant (Recommended) Work Practices will be used.** Work practices R1 and R2 are based on "Recommended Work Practices for the Removal of Resilient Floor Coverings," revised August, 1995, published by the Resilient Floor Covering Institute (RFCI) and Armstrong World Industries, Inc. OSHA has agreed that these "Recommended Work Practices" are an example of compliant work practices. If these work practices need to be modified due to specific circumstances of a facility, caution should be used to insure that the changes do not change their status as examples recognized by OSHA. If any change is going to be made to the work procedures, the O&M designer should refer to the original "Recommended Work Practices" and the OSHA Compliance Directive to insure that the new procedure is still a "Compliant Work Practice"
- **Workers are properly trained.** Workers using the Recommended Work Practices for the removal of resilient floor covering materials must have completed an 8-hour training program as required by the OSHA regulation 29 CFR

1926.1101 and the compliance directive. The course must cover asbestos subjects as well as training in the Recommended Work Practices. A Competent Person involved in removal of intact flooring material using compliant work practices must have completed an 8-hour worker training program and additional 4 hours of training (a total of 12 hours of training) as required by the Settlement Agreement.

- **The resilient flooring is intact and is likely to remain intact throughout the removal process.** Intact in this instance means that the ACM has not crumbled, been pulverized, or otherwise deteriorated so that it is no longer likely to be bound with its matrix. In the Settlement Agreement OSHA agreed that the incidental breakage of flooring material, including slicing of sheet vinyl floor covering with a sharp-edged instrument, during removal operations using "Compliant Work Practices" does not mean that the material is not removed in an "intact" condition. Rather, the issue of whether flooring material is "intact" is determined by whether the flooring material (whether broken or not) has crumbled, been pulverized, or has otherwise deteriorated so that it is not likely to be bound with its matrix.

A Negative Exposure Assessment is not justified if these three conditions are not met. If a negative exposure assessment is not or cannot be made, or if applicable OSHA exposure limits are exceeded, other provisions and requirements of the OSHA asbestos regulation remain in full force and effect.

If a job begins as an intact removal, but the material being removed becomes non-intact or no longer can be removed intact, work must be stopped until workers and a competent person with the appropriate training and engineering controls required for non-intact (or aggressive) removal methods, are put into place. For a discussion of these removal methods, refer to the NIBS *Model Guide Specifications Asbestos Abatement and Management in Buildings* specification section 02087, "Resilient Flooring Removal - Aggressive Asbestos Abatement." OSHA reserved the right to reconsider its determination that a negative exposure assessment for particular floor removal operations may be based solely on the data in the rulemaking record if OSHA field data or other information, weighed against the data in the rulemaking record, show that exposures during particular floor removal operations in which compliant work practices are used are likely to exceed the TWA or Excursion Limit.

- A "Competent Person" must supervise the work and have authority to take prompt

corrective measures to eliminate hazards to the health and safety of workers. This does not mean that the Competent Person is required to be on-site at all times during the work, but that person must inspect the job site frequently and regularly, at any time at an employee request, and at other appropriate times, such as to access if conditions have changed. (Note that a project may have more than one Competent Person.) For work on intact resilient flooring, the Competent Person must, as a minimum, have the 12 hours of training required by OSHA for a Competent Person involved in removal of intact flooring material using compliant work practices. If non-intact resilient flooring is involved, or if the flooring cannot be removed intact, then the competent person must have completed a 40 hour training course meeting the criteria of EPA's Model Accreditation Plan for supervisors. The training required for intact resilient flooring removal differs from that required for competent persons for other asbestos abatement activities. Most other abatement activities require a minimum of 40 hours of training for a Competent Person, as opposed to the 12 hours required for intact resilient flooring work. The training required for resilient flooring work could be included in the longer course, but this needs to be verified by the designer.

-
- **Recommended Work practices must be used.** The designer must insure that the work procedures used in a facility are equivalent to the “Recommended Work Practices” published by the resilient flooring manufacturers. Work practices R1 and R2 are equivalent to the “Recommended Work Practices” which OSHA has accepted as an example of “Compliant Work Practices.” If these work practices need to be modified to suit conditions in a particular facility, the designer should make a determination about whether the work practice is equivalent to the “Recommended Work Practices.” A negative exposure assessment will be necessary before using a work procedure that is changed enough that it is no longer equivalent. Refer to the NIBS *Model Guide Specification Asbestos Abatement and Management in Buildings* specification Section 02085 “Resilient Flooring Removal - Resilient Floor Covering Manufacturers’ Recommended Work Practices,” for information on additional work practices.
 - **Compliance with OSHA is a minimum requirement.** If the owner or O&M designer wants to specify more stringent standards than OSHA requires, then refer to the section later in this introduction on “Optional Quality Control Measures.”
 - **Compliance with state and local regulations:** In addition to federal regulations, various other state and local government agencies have regulations governing the removal of in-place ACM. Some state and local regulations differ from federal regulations and may be more stringent. It is recommended that the specifier determine whether such regulations apply.

CONSIDERATIONS REGARDING THE USE OF WORK PRACTICES R1 AND R2:

The use of work practices R1 and R2 is dependent upon a competent person making a Negative Exposure Assessment (NEA) as described above. The O&M designer and the Asbestos Program Manager should be familiar with the requirements for the NEA and with the OSHA Compliance Directive (2-2.63 November 3, 1995) that sets forth these requirements. The O&M

designer should be convinced that it is realistic to make an NEA for materials and conditions in the facility.

Compliant work practices such as the Manufacturers’ Recommended Work Practices upon which work practices R1 and R2 are based, when followed, can provide an effective means to control occupational exposures below those limits set by OSHA. [The air

monitoring performed for OSHA exposure monitoring does not distinguish between asbestos and non-asbestos fibers and cannot measure the short or thin fibers that may be detected using transmission electron microscopy (TEM) analysis.] Refer to APM-6 for more information on air monitoring

O&M program designers considering resilient flooring removal work practices should consider means to prevent influence of other asbestos related work on any clearance monitoring (especially using TEM analysis) which may be specified for the flooring removal. The reverse, i.e., preventing influence from the flooring removal project on the TEM clearances of other asbestos related work, should also be considered. Methods to consider include proper sequencing of the different removal projects, use of critical barriers and project decontamination procedures, and having the resilient flooring removal performed using the "Optional Quality Control Measures" discussed later in this introduction.

Use of compliant work practices such as the Manufacturers' Recommended Work Practices upon which work practices R1 and R2 are based, have been found by OSHA to consistently result in worker exposures below the TWA and Excursion Limit established by the revised OSHA standard. However, under certain circumstances such as sanding, drilling, sawing, or mechanical chipping the flooring

material may be rendered (or already have been rendered) friable or not intact. In general, Level B+ worker and area protection work practices should be used if flooring material has been found to be asbestos-containing and is or becomes friable or not intact, or if additional quality control measures are desired.

If asbestos-containing resilient floor covering material is found to be friable, or becomes friable during removal, it is regulated as ACM under the NESHAP, and NESHAP notification, emission control, transportation and waste disposal requirements may apply. Similarly, if floor covering in schools (grades K-12) is or becomes friable, removal performed as an abatement action is covered by EPA Asbestos Emergency Response Act (AHERA, 40 CFR 763.90(I)(v)) regulations, and design, contractor and abatement worker accreditation, and area clearance requirements apply for work greater than small-scale, short duration.

To obtain a complete copy of the work practices booklet and/or a copy of the reports discussed above, contact:

Resilient Floor Covering Institute
966 Hungerford Drive, Suite 12-b
Rockville, Md 20850
(301)340-8580

Armstrong World Industries, Inc.
P.O. Box 3001
Lancaster, Pa 17604
(800) 438-5954

Optional Quality Control Measures

This section presents several optional quality control measures that the designer may want to consider when working in occupied buildings, although these measures are not required by OSHA. These optional measures can provide a range of quality assurances for the owner including: assurance that asbestos fibers will not migrate beyond the work area in case of method failure; indication of whether the work practices are performing as expected; and indication of whether additional clean-up is necessary.

- **Critical Barriers:** Critical barriers over openings into the work area may be specified: if the owner or designer wants to physically isolate the work from adjacent areas, for example, in occupied buildings, or if there is a requirement for TEM clearance sampling in an adjacent abatement work area. This can be specified by adding Worker General Procedure W5 "Critical Barriers" to the work practice.
- **Air Monitoring:** The Owner may specify air monitoring inside the area where work is occurring to verify that the work practices are resulting in airborne asbestos levels within the owner's parameters. Air monitoring may be performed in adjacent areas to assure that these areas are not affected by the work. Air monitoring may be desired to help avoid conflicts with TEM clearance of adjacent asbestos abatement project areas. This can be specified by adding Worker General Procedure W 8 "Beginning and Conduction Air Monitoring" and/or W16 "Visual Inspection and Completing Air Monitoring" to the work practice.
- **Full-time On-site Competent Person:** The owner or O&M designer may specify a full-time on-site competent person to supervise the work and help assure that flooring materials stay intact during the entire work process and that proper work practices are followed throughout the job. This can be accomplished by adding this specification at the beginning of the work practice.
- **Respirators:** The owner or designer may specify respiratory protection for workers to assure minimal exposure to airborne asbestos, including fibers which are not counted under the OSHA standard. This can be specified by adding Worker General Procedure W6 "Putting On Respirators and Performing Fit Checks" to the work practice.
- **Worker Decontamination:** The Owner to Designer may specify worker decontamination (e.g. workers HEPA vacuuming off clothing while standing on drop cloths) as an additional assurance that asbestos-containing debris or

dust will not be carried to areas outside the work area, or to workers' homes. If respirators are specified, there should be some sort of worker decontamination procedure to precede removal of respirators. Worker General Procedure W15 "Worker Decontamination and Removal of Protective Clothing and Respiratory," contains work practices such as changing suits and HEPA vacuuming workers as a

dry decontamination procedure. These work practices can be adapted by adding W15 to the work practice.

- **Other Controls:** If other controls such as bagging and labeling clothing and equipment can be specified by adding the appropriate Worker General Procedure to the work practice.

CLEANING, POLISHING AND BUFFING RESILIENT FLOORING:

Level A: This work is defined in terms of "housekeeping" in the general industry standard (29 CFR 1910.1001) and the construction standard (29 CFR 1926.1101(l)). It encompasses certain housekeeping operations, such as cleaning, buffing or polishing of resilient flooring, governed by the general industry standard, 29 CFR 1910.1001, where either: (1) a determination has been made that these activities using the work practices in this manual (which are based on those contained in the OSHA regulations) are not reasonably expected to result in exposures exceeding the PEL; (2) the employer has monitored after March 31, 1992 for the TWA permissible exposure limit and/or excursion limit and the monitoring satisfies the requirements of 1910.1001(d); or (3) the employer has relied on objective data (see pg. 4-8 for explanation of objective data). In addition, housekeeping operations performed incidental to construction work

are governed by the construction standard, 29 CFR 1926.1101(l), and are also within Level A when an NEA has been made in accordance with paragraph 1926.1101(f)(2). See Level A2 in Figure 2 in the introduction for a checklist of requirements.

Work practices: required for this work are those set forth in the OSHA general industry standard for non-construction-related housekeeping activities. Awareness training is required for workers. Paragraph (k) of the general industry standard has specific requirements for stripping of finishes and burnishing or dry buffing asbestos-containing flooring. Work practices R5 "Wet Strip Floor Wax from Resilient Flooring," R6 "Dry or Spray Buffing Resilient Asbestos Flooring," and R7 "Cleaning Resilient Asbestos Flooring," are based on the OSHA work practices.

NESHAP:

The NESHAP regulates the disposal of ACM. Non-friable materials such as resilient flooring are treated differently from friable materials such as surfacing materials and thermal system insulation. Resilient floor covering is classified by the EPA NESHAP as Category I non-friable ACM. If Category I ACM has become friable, or will become friable, or

has been or will be subjected to sanding, grinding, cutting or abrading, it is defined as Regulated ACM by NESHAP, and its wetting, labeling and disposal requirements apply. State and local regulations may have different requirements, and these may be more stringent.

OTHER CONSIDERATIONS:

Careful work practices should be the primary means used to prevent releases of asbestos fibers during O&M work. Such practices include control measures such as wetting and local exhaust that control or collect fibers at the source. The goal of all asbestos O&M work should be to

prevent any exposure of the worker and unnecessary contamination of the work area, drop cloths, mini-enclosures and other secondary control devices. Mini-enclosures should never be used to excuse sloppy work or creation of "bigger" messes.

R1 . Summary

Removal of resilient asbestos floor tiles

Summary

This work practice covers the O&M procedures for removing small amounts of asbestos-containing floor tile and/or mastic. The work practices are based on the RFCM procedures.

Examples

- Level A:**
- A. Replacement of several floor tiles that are loose or can be removed with minimal or no breakage, and tile and/or mastic does not become friable.
 - B. Remove a small area of well-adhered tile and/or mastic that is not likely to become friable.
 - C. Remove several floor tiles and mastic to drill hole(s) in subfloor to attach object to floor or install a pipe or conduit.
- Level B+:**
- A. Replacement of a small area of tiles that are sufficiently damaged that the tile and/or mastic will become friable during removal.
 - B. Remove a tile and mastic which may become friable during removal.
 - C. Remove several floor tiles and mastic that are sufficiently damaged that the tile and/or mastic will become friable during removal to drill hole(s) in subfloor to attach object to floor or install a pipe or conduit.
-

Related Work Practices

- R 2 Replacement of vinyl sheet flooring with ACM backing.
-

Worker Recommendations:

One worker for Level A work. One or two workers for Level B+ depending upon safety and efficiency considerations. For Level B+ a person with air monitoring training might be required. This person can be a worker.

R1 . Level A

Replacement of resilient asbestos floor tiles

Example

The following are examples of work that can be performed using the procedures of this Level A work practice:

- A. Replacement of several floor tiles that are loose or can be removed with minimal or no breakage, and tile and/or mastic does not become friable.
 - B. Remove a small area of well-adhered tile and/or mastic that is not likely to become friable.
 - C. Remove of several floor tiles and mastic to drill hole(s) in subfloor to attach object to floor or install a pipe or conduit.
-

Notes

RFCM Procedure. This work practice is based on the resilient floor covering manufacturers recommended work practice. You must have had a minimum of 8 hours of training in the use of the recommended work practices including hands on training to do the work of this procedure. A Negative Exposure Assessment must have been made by a Competent Person before this work practice is used.

Warning: Do not sand resilient flooring. Do not use this procedure for activities that crumble, pulverize, or otherwise deteriorate resilient flooring to the extent that it is no longer bound with its matrix.

If job conditions change, stop work and notify your supervisor.

Work Practice

1. Perform Pre-work activities on Level A checklist.
2. Verify that a negative exposure assessment (NEA) has been made. If an NEA cannot be verified, stop work and notify your supervisor.
3. Tools, equipment and materials:
 - a. Tools as needed from the lists in General Procedure W1
 - b. Weighted scraper with long handle
 - c. Wall scraper 2-3" (50-75 mm) wide stiff blade w/short handle
 - d. Commercial-type hand-held hot air blower or radiant heat source
 - e. Safety glasses
 - f. Wet/dry type HEPA vacuum with hose and attachments with metal floor tool
 - g. Garden sprayer with amended water
 - h. Hammer
 - i. Crushed dry ice (for procedure 5B) - approximately 1 lb (0.5 kg) per sq.ft. (0.1)
4. Place tools, equipment and materials needed in work area.
5. Complete Worker General Procedure W4 "Secure Work Area"

R1 . Level A ... continued

6. Use the following procedure to remove resilient tile floor covering:
 - a. Floor tiles must be wetted (misted with a garden sprayer) before actual removal begins, unless heat will be used to remove tiles.
 - b. Start removal by carefully wedging a wall scraper in the seam of two adjoining tiles and gradually forcing the edge of one of the tiles up and away from the floor. Continue to force the balance of the tile up by working the scraper beneath the tile. Exert both a forward pressure and a twisting action on the blade to promote release of the tile from the adhesive and the floor.
 - c. When the tile is removed place it, without breaking it further into smaller pieces, in a waste bag or waste container.
 - d. If it is necessary to remove more tiles to accomplish the work, after the first tile is removed and accessibility to other tiles is improved, force the wall scraper under the exposed edge of another tile. Continue to exert a prying twisting force to the scraper as it is moved under the tile until the tile releases from the floor. Again, dispose of the tile, by placing in a waste bag or waste container without additional breaking. Continue in this manner until enough tiles are removed to accomplish the work.
 - e. Force the scraper through tightly-adhered areas by striking the scraper handle with a hammer using blows of moderate force while maintaining the scraper at a 25 to 30 degree angle to the floor. The resilient floor covering manufacturers' work practices recommend the use of safety goggles during this work.
 - f. Continue to wet (mist) the tiles throughout the procedure
 - g. It should be the goal to remove individual tiles as a complete unit, although breakage of tiles is unavoidable.
 - h. If the procedure above is inadequate to loosen tiles use heat to soften adhesive, or alternatively, without first prying up floor tiles using a scraper, thoroughly heat the tile(s) with a hot air gun or radiant heat source until the heat penetrates through the tile and softens the adhesive, and remove tiles by hand or by using a scraper. The resilient floor covering manufacturers work practices recommend that the hot air gun or radiant heat source, tiles and adhesive be carefully handled to avoid burns, and that heated tiles and adhesive be handled only with suitable glove protection for hands. **Caution:** Over-heating resilient tile might produce harmful vapors, and a respirator with organic vapor cartridges might be needed.
 - i. Deposit tiles in a waste bag or leak-tight container. Do not attempt to break tiles after they are in bag.
 - j. Wet scrape residual adhesive.

R1 . Level A ... continued

7. **Dry ice tile removal procedures:** This method can be used as an alternative to the manufacturers' recommended work practices for removal of tiles:
 - a. **Caution:** The use of dry ice produces carbon dioxide that can result in an oxygen deficiency in the work area. Dry ice can also cause frostbite to workers and damage building materials.
 - b. Spread crushed dry ice over tiles to be removed. Let dry ice freeze mastic and release tile. Use short-handled scraper to pry up tiles.
 - c. When the tile is removed, place it, without breaking it, in disposal bags or containers which will be used for disposal. Removed tiles can be placed in empty tile cartons first and then placed in the disposal bags. To prevent tearing of the bag, place a maximum of one full carton of removed tile in a bag.
 - d. Wet scrape residual adhesive.
8. **Wet Scrape Residual Adhesive:** After removing tile always wet scrape the residual adhesive to remove any loose material using the following procedure so that no ridges or puddles are evident and what remains is a thin, smooth film.
 - a. Moisten the adhesive with water mixed with liquid dishwashing detergent (to aid in wetting the adhesive). Wet scrape with a stiff-bladed wall or floor scraper removing ridges and any loose adhesives.
 - b. Place loosened adhesive residues into a waste bag or waste container
 - c. Wet vacuum standing water with HEPA wet/dry vacuum. Use Work Practice M31 if HEPA vacuum needs maintenance, or if bag or filter needs to be replaced.
 - d. Continue the above steps until what remains of the residual asphaltic "cut-back" adhesive is a thin, smooth film.
9. **Wet Remove residue of adhesive from Concrete with Wet Sand and Rubbing Stones:** If work that could disturb the adhesive residue, such as drilling through the floor, is going to occur, completely remove residue of adhesive left after removal of resilient floor tile using either this procedure or the removal solution procedure that follows:
 - a. Place a small amount of cutting sand (enough to cover area of removed tile) into a container, add water mixed with liquid detergent (1 ounce (30 ml) of liquid dishwashing detergent to 1 gallon (3.79 liters) of water) to dampen the sand (20 pounds (9.07 kg) of sand to ½ gallon (1.89 liters) of solution).
 - b. Place sand over area of removed tile and wet remove the existing adhesive residue with a hand held rubbing stone. The sand and subfloor must be continuously kept wet.
 - c. Occasionally push away cutting sand from the subfloor with a wall or floor scraper to check for complete removal.
 - d. Wet-scrape sand into a pile using a stiff-bladed floor or wall scraper and place sand and adhesive residue in a waste bag or waste container.

R1 . Level A ... continued

- e. Rinse area with clear clean water using a hand sprayer. Avoid getting sand on boots. Worker's boots should also be rinsed and cleaned if necessary
 - f. Wet-vacuum standing water with HEPA wet/dry vacuum with a metal floor attachment (no brush).
 - g. Continue with the above steps until adhesive is completely removed in the required area.
 - h. Allow subfloor to dry and vacuum up any remaining dirt or sand using a vacuum equipped with a HEPA filter and metal floor attachment (no brush).
 - i. Use Work Practice M22 if HEPA vacuum needs maintenance, or if bag or filter needs to be replaced. .
 - j. Wet-wipe and/or wash down all equipment used during the work.
10. **Wet Remove residue of adhesive from Concrete with Removal Solution:** If work that could disturb the adhesive residue, such as drilling through the floor, is going to occur, completely remove residue of adhesive left after removal of resilient floor tile using either the following procedure or the previous wet sand and rubbing stone procedure:
- a. Put the removal solution onto the residual adhesive with a hand sprayer or rag over the area of removed tile. Put enough removal solution (e.g. "mop on, mop off, no machine scrub" stripping solution) to ensure that the area is thoroughly wet. Allow the area to soak for 5-10 minutes. Remove the adhesive by hand scrubbing with a piece of a black floor pad (or equivalent). The subfloor must be kept continuously wet.
 - b. Occasionally push away the adhesive slurry from the subfloor with a wall or floor scraper to check for complete removal. Continue to scrub the floor with the black pad, in the same area until the concrete subfloor is cleaned to the desired degree.
 - c. Wet HEPA vacuum the adhesive slurry. When the HEPA vacuum is full, place a commercially suitable water absorbent into the HEPA container until the adhesive slurry is absorbed. Use Work Practice M22 if HEPA vacuum needs maintenance, or if bag or filter needs to be replaced.
 - d. Rinse area with clear clean water using a hand sprayer or mop. Avoid getting remover on boots. Worker's boots should also be rinsed and cleaned if necessary.
 - e. Wet-vacuum standing water with HEPA wet/dry vacuum with a metal floor attachment (no brush).
 - f. Continue with the above steps until adhesive is completely removed in the required area.
 - g. Allow subfloor to dry and vacuum using a vacuum equipped with a HEPA filter and metal floor attachment (no brush).

R1 . Level A ... continued

- h. Use Work Practice M22 if HEPA vacuum needs maintenance, or if bag or filter needs to be replaced.
 - i. Wet-wipe and/or wash down all equipment used during the work.
11. Perform required clean-up and tear-down steps on Level A checklist to complete work.

R1 . Level B+

Replacement of resilient asbestos floor tiles

Example

The following are examples of work that can be performed using the procedures of this Level B+ work practice.

- A. Replacement of a small area of badly damaged tiles that are sufficiently damaged that the tile and/or mastic will become friable during removal.
 - B. Remove a tile and mastic which may become friable during removal.
 - C. Remove several floor tiles and mastic that are sufficiently damaged that the tile and/or mastic will become friable during removal to drill hole(s) in subfloor to attach object to floor or install a pipe or conduit.
-

Notes

Before starting work you must have, at no cost to you, have: been supplied with the proper respirator and trained in its use, have received at least 32 hours of training as an asbestos abatement worker and in safe work practices and in the use of the equipment found on the job, and had a medical examination made available. If these things have not been done, stop work, and notify your supervisor.

Warning: Do not sand resilient flooring.

Use caution to prevent fire in the work area if heat sources are used.

Work Practice

1. Perform Pre-work activities on Level B+ checklist.
2. Verify that a negative exposure assessment (NEA) has been made. If an NEA cannot be verified, stop work and notify your supervisor.
3. Tools, equipment and materials:
 - a. Tools as needed from the lists in General Procedure W1
 - b. Weighted scraper with long handle
 - c. Wall scraper 2-3" (50-75 mm) wide stiff blade w/short handle
 - d. Commercial-type hand-held hot air blower or radiant heat source
 - e. Safety glasses
 - f. Wet/dry type HEPA vacuum with hose and attachments with metal floor tool
 - g. Garden sprayer with amended water
 - h. Hammer
 - i. Crushed dry ice (if needed) - approximately 1 lb (0.5 kg) per sq.ft. (0.1)
4. Place tools, equipment and materials needed in work area.
5. Complete Worker General Procedure W4 "Secure Work Area"
6. Complete Worker General Procedure W5 "Critical Barriers"

R1 . Level B+ ... continued

7. Use the following procedure to remove resilient tile floor covering:
 - a. Floor tiles must be wetted (mist)ed with a garden sprayer) before actual removal begins, unless heat will be used to remove tiles.
 - b. Start removal by carefully wedging a wall scraper in the seam of two adjoining tiles and gradually forcing the edge of one of the tiles up and away from the floor. Continue to force the balance of the tile up by working the scraper beneath the tile. Exert both a forward pressure and a twisting action on the blade to promote release of the tile from the adhesive and the floor.
 - c. When the tile is removed place it, without breaking it further into smaller pieces, in a waste bag or waste container.
 - d. If it is necessary to remove more tiles to accomplish the work, after the first tile is removed and accessibility to other tiles is improved, force the wall scraper under the exposed edge of another tile. Continue to exert a prying twisting force to the scraper as it is moved under the tile until the tile releases from the floor. Again, dispose of the tile, by placing in a waste bag or waste container without additional breaking. Continue in this manner until enough tiles are removed to accomplish the work.
 - e. Force the scraper through tightly-adhered areas by striking the scraper handle with a hammer using blows of moderate force while maintaining the scraper at a 25 to 30 degree angle to the floor. The resilient floor covering manufacturers work practices recommends use of safety goggles during this work.
 - f. Continue to wet (mist) the files throughout the procedure
 - g. It should be the goal to remove individual tiles as a complete unit, although breakage of tiles is unavoidable.
 - h. If the procedure above is inadequate to loosen tiles use heat to soften adhesive, or alternatively, without first prying up floor tiles using a scraper, thoroughly heat the tile(s) with a hot air gun or radiant heat source until the heat penetrates through the tile and softens the adhesive, and remove tiles by hand or by using a scraper. The resilient floor covering manufacturers work practices recommend that the hot air gun or radiant heat source, tiles and adhesive be carefully handled to avoid burns, and that heated tiles and adhesive be handled only with suitable glove protection for hands.
 - i. Deposit tiles in a waste bag or leak-tight container. Do not attempt to break tiles after they are in bag.
 - j. Wet scrape residual adhesive.
8. **Dry ice tile removal procedures:** This method can be used as an alternative to the manufacturers' recommended work practices for removal of tiles:
 - a. **Caution:** The use of dry ice produces carbon dioxide that can result in an oxygen deficiency in the work area. Dry ice can also cause frostbite to workers and damage building materials.

R1 . Level B+ ... continued

- b. Spread crushed dry ice over tiles to be removed. Let dry ice freeze mastic and release tile. Use short-handled scraper to pry up tiles.
 - c. When the tile is removed, place it, without breaking it, in disposal bags or containers which will be used for disposal. Removed tiles can be placed in empty tile cartons first and then placed in the disposal bags. To prevent tearing of the bag, place a maximum of one full carton of removed tile in a bag.
 - d. Wet scrape residual adhesive.
9. **Wet Scrape Residual Adhesive:** After removing tile always wet scrape the residual adhesive to remove any loose material using the following procedure so that no ridges or puddles are evident and what remains is a thin, smooth film.
- a. Moisten the adhesive with water mixed with liquid dishwashing detergent (to aid in wetting the adhesive). Wet scrape with a stiff-bladed wall or floor scraper removing ridges and any loose adhesives.
 - b. Place loosened adhesive residues into a waste bag or waste container
 - c. Wet vacuum standing water with HEPA wet/dry vacuum. Use Work Practice M22 if HEPA vacuum needs maintenance, or if bag or filter needs to be replaced.
 - d. Continue the above steps until what remains of the residual asphaltic "cut-back" adhesive is a thin, smooth film.
10. **Wet Remove residue of adhesive from Concrete with Wet Sand and Rubbing Stones:** If work that could disturb the adhesive residue, such as drilling through the floor, is going to occur, completely remove residue of adhesive left after removal of resilient floor tile using either this procedure or the removal solution procedure that follows:
- a. Place a small amount of cutting sand (enough to cover area of removed tile) into a container, add water mixed with liquid detergent (1 ounce (30 ml) of liquid dishwashing detergent to 1 gallon (3.79 liters) of water) to dampen the sand (20 pounds (9.07 kg) of sand to ½ gallon (1.89 liters) of solution).
 - b. Place sand over area of removed tile and wet remove the existing adhesive residue with a hand held rubbing stone. The sand and subfloor must be continuously kept wet.
 - c. Occasionally push away cutting sand from the subfloor with a wall or floor scraper to check for complete removal.
 - d. Wet-scrape sand into a pile using a stiff-bladed floor or wall scraper and place sand and adhesive residue in a waste bag or waste container.
 - e. Rinse area with clear clean water using a hand sprayer. Avoid getting sand on boots. Worker's boots should also be rinsed and cleaned if necessary
 - f. Wet-vacuum standing water with HEPA wet/dry vacuum with a metal floor attachment (no brush).

R1 . Level B+ ... continued

- g. Continue with the above steps until adhesive is completely removed in the required area.
 - h. Allow subfloor to dry and vacuum up any remaining dirt or sand using a vacuum equipped with a HEPA filter and metal floor attachment (no brush).
 - i. Use Work Practice M22 if HEPA vacuum needs maintenance, or if bag or filter needs to be replaced.
 - j. Wet-wipe and/or wash down all equipment used during the work.
11. **Wet Remove residue of adhesive from Concrete with Removal Solution:** If work that could disturb the adhesive residue, such as drilling through the floor, is going to occur, completely remove residue of adhesive left after removal of resilient floor tile using either the following procedure or the previous wet sand and rubbing stone procedure:
- a. Put the removal solution onto the residual adhesive with a hand sprayer or rag over the area of removed tile. Put enough removal solution (e.g. "mop on, mop off, no machine scrub" stripping solution) to ensure that the area is thoroughly wet. Allow the area to soak for 5-10 minutes. Remove the adhesive by hand scrubbing with a piece of a black floor pad (or equivalent). The subfloor must be kept continuously wet.
 - b. Occasionally push away the adhesive slurry from the subfloor with a wall or floor scraper to check for complete removal. Continue to scrub the floor with the black pad, in the same area until the concrete subfloor is cleaned to the desired degree.
 - c. Wet HEPA vacuum the adhesive slurry. When the HEPA vacuum is full, place a commercially suitable water absorbent into the HEPA container until the adhesive slurry is absorbed. Use Work Practice M22 if HEPA vacuum needs maintenance, or if bag or filter needs to be replaced.
 - d. Rinse area with clear clean water using a hand sprayer or mop. Avoid getting remover on boots. Worker's boots should also be rinsed and cleaned if necessary.
 - e. Wet-vacuum standing water with HEPA wet/dry vacuum with a metal floor attachment (no brush).
 - f. Continue with the above steps until adhesive is completely removed in the required area.
 - g. Allow subfloor to dry and vacuum using a vacuum equipped with a HEPA filter and metal floor attachment (no brush).
 - h. Use Work Practice M22 if HEPA vacuum needs maintenance, or if bag or filter needs to be replaced.
 - i. Wet-wipe and/or wash down all equipment used during the work.
12. Perform required clean-up and tear-down steps on Level B checklist to complete work.

R2 . Summary

Replacement of vinyl sheet flooring with ACM backing

Summary

This work practice covers the O&M procedures for the replacement of small amounts of vinyl sheet flooring with ACM backing. Wet scraping of residual felt is included in both Levels.

Examples

- Level A:**
- A. Replacement of a small area of loose or perimeter-adhered vinyl sheet flooring with ACM backing.
 - B. Replacement of a small area of adhered vinyl sheet flooring with ACM backing that can be removed using non-aggressive, primarily manual methods. Some separation of backing and wear layer will occur.
 - C. Remove small amounts of resilient asbestos flooring covering to drill hole(s) in subfloor to attach object to floor or install a pipe or conduit.
- Level B+:**
- A. Replacement of a small area of vinyl sheet flooring with ACM backing which is sufficiently damaged to be friable
 - B. Removal of a small area of vinyl sheet flooring with ACM backing which may become friable during removal.
 - C. Remove small amounts of resilient asbestos flooring covering which may become friable during removal to drill hole(s) in subfloor to attach object to floor or install a pipe or conduit.
-

Related Work Practices

- R 1 Replacement of resilient asbestos floor tiles.
 - R 3 Install new resilient flooring or carpet over resilient asbestos flooring.
 - R 8 Remove carpet over resilient asbestos flooring.
-

Worker Recommendations:

Two workers for Level A or B+ depending upon safety and efficiency considerations. For Level B+ a person with air monitoring training might be required. This person can be a worker.

R2 . Level A

Replacement of vinyl sheet flooring with ACM backing

Example

The following are examples of work that can be performed using the procedures of this Level A work practice.

- A. Replacement of a small area of loose or perimeter-adhered vinyl sheet flooring with ACM backing.
 - B. Replacement of a small area of adhered vinyl sheet flooring with ACM backing that can be removed using non-aggressive, primarily manual methods. Some separation of backing and wear layer will occur.
 - C. Remove small amounts of resilient asbestos flooring covering to drill hole(s) in subfloor to attach object to floor or install a pipe or conduit.
-

Notes

RFCM Procedure. This work practice is based on the resilient floor covering manufacturers recommended work practice. You must have had a minimum of 8 hours of training in the use of the recommended work practices including hands on training to do the work of this procedure. A Negative Exposure Assessment must have been made by a Competent Person before this work practice is used.

Warning: Do not sand resilient flooring. Do not use this procedure for activities that crumble, pulverize, or otherwise deteriorate resilient flooring to the extent that it is no longer bound with its matrix.

Work Practice

1. Perform Pre-work activities on Level A checklist.
2. Verify that a negative exposure assessment (NEA) has been made. If an NEA cannot be verified, stop work and notify your supervisor.
3. Tools, equipment and materials:
 - a. Tools as needed from the lists in General Procedure W1
 - b. Weighted scraper with long handle
 - c. Wall scraper 2-3" (50-75 mm) wide stiff blade w/short handle
 - d. Commercial-type hand-held hot air blower or radiant heat source
 - e. Safety glasses
 - f. Wet/dry type HEPA vacuum with hose and attachments with metal floor tool
 - g. Garden sprayer with amended water
 - h. Hammer
 - i. Hook knife
4. Place tools, equipment and materials needed in work area.
5. Complete Worker General Procedure W4 "Secure Work Area"

R2 . Level A ... continued

6. Use the following procedure to completely remove adhered resilient sheet flooring.
 - a. Use a minimum of two workers for this procedure.
 - b. Slice around area to be removed. Make a series of parallel slices, with a knife, 4 to 8 inches (102 to 203 mm) apart parallel to a wall.
 - c. Pry up the corner of the first strip, separating the backing layer. As the strip is being removed, spray a constant mist of the detergent solution into the delamination nip point to minimize any airborne dust particles. When done properly, any felt remaining on the floor and on the back of the strip will be thoroughly wet. Peel the strip either by pulling upward at an angle that permits the best separation or by rolling around a core.
 - d. Roll the strip tightly as it is removed. Tie or tape securely and immediately place in a waste bag or waste container for disposal.
 - e. If parts of the foam inner-layer remain stuck to the backing, attempt to eliminate this condition by pulling the strips loose from the opposite end. Peel the foam inner-layer from the floor while spraying the detergent solution into the delamination nip point.
 - f. Some resilient flooring is not readily strippable by hand. When these conditions are encountered, a sharp stiff blade scraper may be used to assist cleavage of the wearlayer from felt. If this procedure is used the distance between slices must be narrowed to a width of 3 to 5 inches (76 to 127 mm).
 - g. Regardless of whether stripping of the wear surface is accomplished by hand peeling alone or with the assistance of a stiff blade scraper, detergent solution must be sprayed into the delamination nip point to minimize any airborne dust particles.
 - h. After removing three strips of the wear surface, remove the remaining residual felt by wet scraping using the procedures "Wet Scraping Residual Felt," in this section. During the stripping process, do not stand or walk on the exposed felt.
 - i. After removing the three strips of flooring and residual felt vacuum the exposed floor using a wet/dry vacuum equipped with a HEPA filter and metal floor attachment (no brush).
 - j. Repeat the operation (wetting the delamination nip point while removing the next three strips, then wet scrape the residual felt, then vacuum the exposed floor). Repeat as necessary until enough flooring is removed to accomplish the work. Do only one three-strip area at a time.
 - k. Place all flooring strips and felt scrapings immediately while wet into waste bags or waste containers. Close full bags and containers tightly and seal securely for disposal.
 - l. Do not dry sweep. Avoid creating dust.
 - m. When all floor covering has been completely removed, let the floor dry. Vacuum up any dirt using a vacuum with a HEPA filtration system and a metal

R2 . Level A ... continued

- floor attachment (no brush). Stand only in the vacuumed area as the work proceeds across the floor. Position the vacuum cleaner so the discharge air does not blow on the floor being cleaned.
- n. After vacuuming, remove used HEPA filters and cleaner bags in accordance with Practice M22.
7. Remove any residual felt remaining on the floor after removal of the wearlayer of adhered vinyl sheet flooring by using the following procedure:
 - a. Thoroughly wet residual felt with detergent solution. Avoid excessive wetting or standing water. Wait a few minutes to allow solution to soak into felt.
 - b. Stand on the remaining floor covering (not the felt) and use a stiff-bladed scraper or a floor scraper with a replaceable blade to remove the wet felt.
 - c. Re-wet the felt if the solution has not completely penetrated, if drying occurs or if dry felt is exposed during scraping. Scrape all felt from each three-strip area before proceeding further. Pick up the scrapings as they are removed from the floor and place in a waste bag or waste container.
 - d. Wet residual felt as above but do not excessively soak or flood wood floors with detergent solution. Excessive water can damage wood floors to the extent that new underlayment could be required. A floor that has been wet scraped must be allowed to dry thoroughly before new resilient flooring is installed.
 - e. As removal progresses, vacuum the area using a vacuum cleaner equipped with a HEPA filter and metal floor attachment (no brush).
 - f. After removal is complete and the entire floor has dried, vacuum using a HEPA vacuum with a metal floor attachment (no brush).
 - g. After vacuuming, remove used HEPA filters and cleaner bags in accordance with Practice M22.
 8. Disposal of materials: Dispose of friable materials in accordance with Worker General Procedure W17 "Waste Transportation, Storage and Disposal."
 9. Perform required clean up and tear-down steps on Level A checklist to complete work.

R2 . Level B+

Replacement of vinyl sheet flooring with ACM backing

Example

The following are examples of work that can be performed using the procedures of this Level B+ work practice.

- A. Replacement of a small amount vinyl sheet flooring with ACM backing which is sufficiently damaged to be friable
- B. Removal of a small amount vinyl sheet flooring with ACM backing which may become friable during removal.
- C. Remove small amounts of resilient asbestos flooring covering which may become friable during removal to drill hole(s) in subfloor to attach object to floor or install a pipe or conduit.

Notes

Before starting work you must have, at no cost to you, have: been supplied with the proper respirator and trained in its use, have received at least 32 hours of training as an asbestos abatement worker and in safe work practices and in the use of the equipment found on the job, and had a medical examination made available. If these things have not been done, stop work, and notify your supervisor.

This work practice is based on the resilient floor covering manufacturers recommended work practice. A Negative Exposure Assessment must have been made by a Competent Person before this work practice is used.

Warning: Do not sand resilient flooring.

Work Practice

1. Perform Pre-work activities on Level B+ checklist.
2. Verify that a negative exposure assessment (NEA) has been made. If an NEA cannot be verified, stop work and notify your supervisor.
3. Tools, equipment and materials:
 - a. Tools as needed from the lists in General Procedure W1
 - b. Weighted scraper with long handle
 - c. Wall scraper 2-3" (50-75 mm) wide stiff blade w/short handle
 - d. Commercial-type hand-held hot air blower or radiant heat source
 - e. Safety glasses
 - f. Wet/dry type HEPA vacuum with hose and attachments with metal floor tool
 - g. Garden sprayer with amended water
 - h. Hammer

R2 . Level B+ ... continued

- i. Hook knife
4. Place tools, equipment and materials needed in work area.
5. Complete Worker General Procedure W4 "Secure Work Area "
6. Use the following procedure to completely remove adhered resilient sheet flooring.
 - a. Use a minimum of two workers for this procedure.
 - b. Slice around area to be removed. Make a series of parallel slices, with a knife, 4 to 8 inches (102 to 203 mm) apart parallel to a wall.
 - c. Pry up the corner of the first strip, separating the backing layer. As the strip is being removed, spray a constant mist of the detergent solution into the delamination nip point to minimize any airborne dust particles. When done properly, any felt remaining on the floor and on the back of the strip will be thoroughly wet. Peel the strip either by pulling upward at an angle that permits the best separation or by rolling around a core.
 - d. Roll the strip tightly as it is removed. Tie or tape securely and immediately place in a waste bag or waste container for disposal.
 - e. If parts of the foam inner-layer remain stuck to the backing, attempt to eliminate this condition by pulling the strips loose from the opposite end. Peel the foam inner-layer from the floor while spraying the detergent solution into the delamination nip point.
 - f. Some resilient flooring is not readily strippable by hand. When these conditions are encountered, a sharp stiff blade scraper may be used to assist cleavage of the wearlayer from felt. If this procedure is used the distance between slices must be narrowed to a width of 3 to 5 inches (76 to 127 mm).
 - g. Regardless of whether stripping of the wear surface is accomplished by hand peeling alone or with the assistance of a stiff blade scraper, detergent solution must be sprayed into the delamination nip point to minimize any airborne dust particles.
 - h. After removing three strips of the wear surface, remove the remaining residual felt by wet scraping using the procedures "Wet Scraping Residual Felt," in this section. During the stripping process, do not stand or walk on the exposed felt.
 - i. After removing the three strips of flooring and residual felt vacuum the exposed floor using a wet/dry vacuum equipped with a HEPA filter and metal floor attachment (no brush).
 - j. Repeat the operation (wetting the delamination nip point while removing the next three strips, then wet scrape the residual felt, then vacuum the exposed floor). Repeat as necessary until enough flooring is removed to accomplish the work. Do only one three-strip area at a time.
 - k. Place all flooring strips and felt scrapings immediately while wet into waste bags or waste containers. Close full bags and containers tightly and seal securely for disposal.

R3 . Summary

Install new resilient flooring or carpet over resilient asbestos flooring

Summary

This procedure covers the work required to prepare resilient asbestos flooring for the installation of new resilient flooring or carpet. This procedure works with work practice R5 for stripping asbestos flooring and assumes that any damaged flooring has been repaired or replaced using applicable work practices such as R1 and R2.

Examples

- Level A:** A. New carpet being installed over well-adhered resilient asbestos floor tile or vinyl sheet flooring with ACM backing in good condition.
-

Related Work Practices

- R 1 Replacement of resilient asbestos floor tiles
 - R 2 Replacement of vinyl sheet flooring with ACM backing.
 - R 5 Wet strip floor wax from resilient asbestos flooring
 - R 6 Buffing resilient asbestos flooring
 - R 7 Cleaning resilient asbestos flooring
-

Worker Recommendations:

One worker is usually sufficient. Two or more workers may be needed to increase efficiency or for additional health and/or safety considerations. A person with air monitoring training might be required. This person can be a worker.

R3 . Level A

Install new resilient flooring or carpet over resilient asbestos flooring

Example

The following is an example of work that can be performed using the procedures of this Level A work practice.

- A. New carpet being installed over well-adhered resilient asbestos tile or vinyl sheet flooring with ACM backing in good condition.

Notes

This work practice must be used in conjunction with General Procedure W1 and a Level A Worker Checklist. The worker checklist includes tasks that must be performed before these work practices are begun.

Review manufacturer's recommendations concerning installation of new flooring over existing before proceeding with this work.

Work Practice

1. Perform Pre-work activities on Level A checklist.
2. Tools, equipment and materials:
 - a. Tools as needed from the lists in General Procedure W1
 - b. Wall scraper 2-3" (50-75 mm) wide stiff blade w/short handle
3. Place tools, equipment and materials needed in work area.
4. Complete Worker General Procedure W4 "Secure Work Area"
5. HEPA vacuum.
6. Strip wax/finish from existing floor using O&M work practice R5 "Wet Strip Wax from Resilient Asbestos Flooring.
7. Level off any minor high spots on floor using scraper. Promptly remove any scrapings with a HEPA vacuum. Do not sand or grind flooring.
8. Fill any low areas using manufacturers recommended underlayment or Leveling compound.
9. Vacuum floor using a vacuum equipped with a HEPA filter and metal floor attachment (no brush).
10. Use Work Practice M22 if HEPA vacuum needs maintenance, or if bag or filter needs to be replaced.
11. Wet-wipe and/or wash down all equipment used scrape floor during the work.
12. Install new flooring or carpet as recommended by manufacturer.
13. Perform clean-up and tear-down on Level A checklist to complete work

R4 . Summary

Install partition over resilient asbestos flooring

Summary

This work practice describe the procedures for installing a wall over resilient asbestos flooring that will remain in place. If flooring will be removed for wall installation, use work practice R1 or

R2.

Note: It may be more efficient to remove flooring using R1 or R2 and then install partition.

Examples

- Level A:** A. Install partition over resilient asbestos flooring that is well adhered and in good condition.
- Level B+:** A. Install partition over resilient asbestos flooring that becomes friable during the partition installation.
-

Related Work Practices

- R 1 Replacement of resilient asbestos floor tiles.
- R 2 Replacement of vinyl asbestos sheet flooring with ACM backing.
- R 3 Install new resilient flooring or carpet over resilient asbestos flooring.
-

Worker Recommendations:

One worker. Two workers may be beneficial for erecting partition. A person with air monitoring training might be required. This person can be a worker.

R4 . Level A

Install partition over resilient asbestos flooring

Example

The following is an example of work that can be performed using the procedures of this Level A work practice.

- A. Install partition over resilient asbestos flooring that is well-adhered and in good condition.
-

Work Practice

1. Perform Pre-work activities on Level A checklist.
2. Tools, equipment and materials:
 - a. Tools as needed from the lists in General Procedure W1
 - b. Anchoring devices and equipment
 - c. Non-asbestos adhesive
3. Place tools, equipment and materials needed in work area.
4. Install base plate of wall on full bed of adhesive and attach to floor using appropriate anchoring devices.
5. HEPA vacuum any chips or dust generated during fastening operation. Use Work Practice M22 if HEPA vacuum needs maintenance, or if bag or filter needs to be replaced.
6. Complete installation of wall.
7. Perform cleanup and tear down steps on Level A checklist to complete work.

R4 . Level B+

Install partition over resilient asbestos flooring

Example

The following is an example of work that can be performed using the procedures of this Level B+ work practice.

- A. Install partition over resilient asbestos flooring that becomes friable during the partition installation.
-

Notes

It might be more efficient to remove flooring using R1 or R2 and then install partition.

Work Practice

1. Perform Pre-work activities on Level B+ checklist.
2. Tools, equipment and materials:
 - a. Tools as needed from the lists in General Procedure W1
 - b. Anchoring devices and equipment
 - c. Non-asbestos adhesive
3. Complete Worker General Procedure W4 "Secure Work Area"
4. Complete Worker General Procedure W10 "Setting Up Work Areas"
5. Complete Worker General Procedure W5 "Critical Barriers"
6. Place tools, equipment and materials needed onto drop cloth.
7. Using garden sprayer with amended water, adequately wet flooring area where work is to be done.
8. Level off any minor high spots on floor using scraper. Do not sand or grind flooring.
9. Remove any damaged vinyl asbestos flooring in area of work using O & M work practice R1 or R2.
10. Fill any low areas using manufacturers recommended Leveling compound.
11. Install base plate of wall on full bed of adhesive and attach to floor using appropriate anchoring devices.
12. HEPA vacuum any chips or dust generated during fastening operation. Use Work Practice M22 if HEPA vacuum needs maintenance, or if bag or filter needs to be replaced.
13. Complete installation of wall.
14. Perform cleanup and tear down steps on Level B checklist to complete work.

R5 . Summary

Wet strip floor wax from resilient asbestos flooring

Summary

This work practice covers the procedures for stripping floor wax or finish from resilient asbestos flooring. Do not strip damaged flooring. Any loose or damaged flooring should be repaired or replaced before stripping is started. Wet stripping, if performed properly, should not cause damage to resilient flooring. If any flooring damage occurs during stripping,

stop work and make repairs using applicable work practice(s). Do not dry strip, scrape, sand, or grind resilient asbestos flooring to remove any blemishes or imperfections.

This procedure is based on the OSHA requirements issued in 1994 as set forth in 29 CFR 1910.1001(l).

Example

- Level A: A. Stripping floor wax or finish coat from resilient asbestos flooring that is well adhered and in good condition.

Related Work Practices

- R 1 Replacement of resilient asbestos floor tiles.
- R 3 Install new resilient flooring or carpet over resilient asbestos flooring.
- R 6 Dry or Spray Buffing resilient asbestos flooring.
- R 7 Cleaning resilient asbestos flooring.

Worker Recommendations:

One worker trained in wet stripping procedures for resilient asbestos flooring. A person with air monitoring training might be required. This person can be the worker.

R5 . Level A

Wet strip floor wax from resilient asbestos flooring

Example

The following is example of work that can be performed using the procedures of this Level A work practice.

- A. Strip floor wax or finish coat from resilient asbestos flooring that is well-adhered and in good condition.
-

Notes

Do not strip damaged flooring. Any loose or damaged flooring should be repaired or replaced before stripping is started. Wet stripping, if performed properly, should not cause damage to resilient flooring. If any flooring damage occurs during stripping, stop work and make repairs using applicable work practice(s). Do not dry strip, scrape, sand, or grind resilient asbestos flooring to remove any blemishes or imperfections.

This procedure is based on OSHA requirements as set forth in 29 CFR 1910.1001(l). Stripping pads should be kept wet during use and rinsed thoroughly immediately after use and prior to storage. Dispose of pads, if contaminated, as ACM waste in labeled disposal bags.

Work Practice

1. Perform Pre-work activities on Level A checklist.
2. Tools, equipment and materials:
 - a. Tools as needed from the lists in General Procedure W1
 - b. "Caution - Wet Floor" signs
 - c. Floor stripping machine
 - d. Stripping Pads (least abrasive pad possible)
 - e. Buckets with water for rinsing
 - f. Mops (for stripping, rinsing and polishing)
 - g. Chemical stripper - recommended amount for area to be stripped
 - h. Floor wax or finish
 - i. Walk-off mats
3. Place tools, equipment and materials needed in work area. Place walk-off mats where required to prevent tracking of stripping solution to other areas. Position "Caution - Wet Floor" signs.
4. After proper mixing of stripping chemical, adequately wet floor by mop applying liberal amounts of the solution. Allow chemical to soak for amount of time recommended by manufacturer. If areas become dry, reapply solution to keep floor adequately wet.

R5 . Level A ... continued

5. After wax or finish has softened, strip flooring using least abrasive pad and low speed setting (300 RPM maximum). Keep floor adequately wet during machine operation. Do not overstrip. Stop stripping when the old wax or finish is removed. Work small areas at a time.
6. Remove dirty stripping solution with wet vacuum or "strip" mop.
7. With "rinse" mop, apply liberal amount of clean water to area stripped and remove water with wet vacuum or mop. Repeat rinse procedures.
8. If some spots of wax or finish remain, restrip those areas.
9. If new flooring will be installed over the stripped floor, do not apply wax or finish. When applying new wax or finish, do so according to manufacturer's recommendations.
10. Perform clean-up and tear-down steps on Level A checklist to complete work.

R6 . Summary

Dry or spray buffing resilient asbestos flooring

Summary

This work practice covers the procedures for spray buffing the polish to restore gloss on resilient asbestos flooring. Do not buff damaged flooring. Any loose or damaged flooring should be repaired or replaced before buffing is started. This practice assumes that the floor has adequate coats of polish, and that the

flooring itself will not be damaged or contacted by the buffing equipment. If any flooring damage occurs during buffing, stop work and make repairs using applicable work practice(s). If polish is in poor condition, use work practice R6 or R8.

Example

Level A: A. Dry or spray buff the polish on resilient asbestos flooring to remove minor surface imperfections and restore gloss.

Related Work Practices

- R 5 Strip floor wax from resilient asbestos flooring.
- R 7 Cleaning resilient asbestos flooring.

Worker Recommendations:

One worker trained in spray buffing procedures for asbestos flooring. A person with air monitoring training might be required. This person can be the worker.

R6 . Level A

Dry or spray buffing resilient asbestos flooring

Example

The following is an example of work that can be performed using the procedures of this Level A work practice.

- A. Dry or spray buff the polish on resilient asbestos flooring to remove minor surface imperfections and restore gloss.
-

Notes

Do not buff damaged flooring. Any loose or damaged flooring should be repaired or replaced before buffing is started. This practice assumes that the floor has adequate coats of polish, and that the flooring itself will not be damaged or contacted by the buffing equipment. If any flooring damage occurs during buffing, stop work and make repairs using applicable work practice(s). If polish is in poor condition, use work practice R5 or R7.

Dispose of pads, if contaminated, as ACM waste in labeled disposal bags.

Work Practice

1. Perform Pre-work activities on Level A checklist.
2. Tools, equipment and materials:
 - a. Tools as needed from the lists in General Procedure W1
 - b. "Caution - Wet Floor" signs
 - c. Floor buffing machine
 - d. Buffing Pads (least abrasive - tan, red, or equivalent)
 - e. Buckets with mop wringer
 - f. Mops (for damp or spot mopping)
 - g. Chemical cleaner
 - h. Hand-held scraper
 - i. Spray buffing compound, appropriately diluted, compatible polish and restorer chemical
3. Place tools, equipment and materials needed in work area. Position "Caution-Wet Floor" signs.
4. Pick up any large loose debris and place into disposal bags. Using scraper and water, remove all foreign matter from the finished surface (gum, tar, stickers, etc.).
5. Spot or damp mop to remove stains and spills. Mix chemical cleaner or restorer with water and apply according to manufacturers recommendations. Spot or damp mop to remove stains and spills. If dry buffing will be performed, apply restorer chemical as required.

R6 . Level A ... continued

6. Allow floor to dry thoroughly.
7. Spray or dry buff as appropriate:
 - a. To spray-buff, spray small area with spray-buff solution and buff using manufacturer's recommended pad or brush at recommended RPM. Repeat procedure until entire area is spray-buffed.
 - b. To dry buff, buff or dry burnish with manufacturer's recommended pad or brush at recommended RPM.
8. Perform applicable steps on Level A checklist to complete work.

R7 . Summary

Cleaning resilient asbestos flooring

Summary

This work practice covers the procedures for cleaning (or scrubbing) the polish on resilient asbestos flooring prior to buffing or application of additional polish. Do not polish loose or damaged resilient flooring. Any damage should be repaired before cleaning begins using the applicable work practice(s). Stop work if any damage occurs during cleaning and make repairs needed.

Example

Level A: A. Clean or scrub resilient asbestos flooring with adequate coats of floor polish on flooring before buffing or application of additional polish.

Related Work Practices

- R 5 Wet strip floor wax from resilient asbestos flooring.
 - R 6 Dry or spray buffing resilient asbestos flooring.
-

Worker Recommendations:

One worker trained in cleaning procedures for asbestos flooring. A person with air monitoring training might be required. This person can be the worker.

R7 . Level A

Cleaning resilient asbestos flooring

Example

The following is an example of work that can be performed using the procedures of this Level A work practice.

- A. Clean or scrub resilient asbestos flooring with adequate coats of floor polish on flooring before buffing or application of additional polish
-

Notes

Do not polish loose or damaged resilient flooring. Any damage should be repaired before cleaning begins using the applicable work practice(s). Stop work if any damage occurs during cleaning and make repairs needed.

Work Practice

1. Perform Pre-work activities on Level A checklist.
2. Tools, equipment and materials:
 - a. Tools as needed from the lists in General Procedure W1
 - b. "Caution - Wet Floor" signs
 - c. Floor scrubbing machine
 - d. Pads (least abrasive)
 - e. Buckets with mop wringer
 - f. Scraper 2-3" (50-75 mm) wide stiff blade
 - g. Mops (for scrubbing, rinsing)
 - h. Measuring device for mixing chemical cleaner
 - i. Walk-off mats
 - j. Chemical cleaner
3. Place tools, equipment and materials needed in work area. Place walk-off mats to prevent tracking of scrubbing solution to other areas. Position "Caution - Wet Floor" signs.
4. Install polyethylene sheet on adjoining floors for protection from any spilled cleaning solution.
5. Mix scrubbing chemical with water as recommended by manufacturer and apply liberal amount (do not flood) using mop. Allow to soak for amount of time recommended by manufacturer. Keep floor adequately wet by reapplying cleaning solution if drying occurs. Work small areas at a time.
6. Using floor scrubbing machine, manufacturer's recommended pads and operating speed, clean floor to remove embedded dirt and surface marks.
7. Remove spent scrubbing solution with wet vacuum or mop.

R7 . Level A ... continued

8. Rinse area using clean mop and clean rinse water. Remove water with wet vacuum or mop. Damp mop area to clean up any remaining water or streaks.
9. Perform applicable steps on Level A checklist to complete work.

R8 . Summary

Remove carpet over resilient asbestos flooring

Summary

This work practice describes the procedures to be used for removing a small area of carpet installed over resilient asbestos flooring for O&M work. These procedures assume that the carpet adhesive or mastic does not contain asbestos, and that contamination is not

present on the top side of the carpet. If a large area is involved, the work might require that abatement procedures be used. If carpet mastic contains asbestos, see Work Practice R1. Removal of well-adhered carpet can pull up resilient asbestos flooring beneath the carpet.

Examples

Level A: A. Remove carpet that is non-adhered or weakly adhered to resilient asbestos flooring.

Level B+: A. Remove carpet adhered to good condition resilient asbestos flooring where mastic and/or a small number of tiles may be pulled up, or flooring may be pulled up without separation of backing and wear layer. Resilient flooring mastic may or may not contain asbestos.

Related Work Practices

R1 Replacement of resilient asbestos floor tiles.

R2 Replacement of vinyl sheet flooring with ACM backing.

R3 Installation of new resilient flooring or carpet over resilient asbestos

Worker Recommendations:

One worker for Level A work. One or two workers for Level B depending upon safety and efficiency considerations.

R8 . Level A

Remove carpet over resilient asbestos flooring

Example

The following is an example of work that can be performed using the procedures of this Level A work practice. If job conditions vary from the examples stop work and notify your supervisor.

- A. Remove carpet that is non-adhered or weakly adhered to resilient asbestos flooring.

Notes

These procedures assume that the carpet adhesive or mastic does not contain asbestos, and that contamination is not present on the top side of the carpet. If a large area is involved, the work might require that abatement procedures be used. If carpet mastic contains asbestos, see Work Practice R1.

Review manufacturer's recommendation concerning installation of new carpet over old flooring and/or adhesive before proceeding with this work. If asbestos-containing adhesive must be removed, refer to wet-scraping procedures in Work Practice R1.

Work Practice

1. Perform Pre-work activities on Level A checklist.
2. Tools, equipment and materials:
 - a. Tools as needed from the lists in General Procedure W1
 - b. Metal straightedge for use when cutting carpet
 - c. Scraper 2-3" (50-75 mm) wide stiff blade
3. Place tools, equipment and materials needed in work area.
4. Find a seam or corner where carpet removal can begin. If no seams or corners exist, make a cut around the piece to be removed. Cut carpet using utility knife with a new blade.
5. Pry up corner or seam of carpet using scraper. Pull back a section large enough (approximately one square foot [0.1 m²]) to hang onto while removing carpet. HEPA vacuum exposed flooring and back of carpet.
6. Pull carpeting back slowly and HEPA vacuum exposed flooring & back of carpet. Remove carpet in pieces no larger than 200 square feet (18.6 m²).
7. If carpet and adhesive are non-ACM, roll up carpet and dispose of as non-ACM waste. If portions of asbestos-containing flooring remain attached to carpet backing, dispose of carpet as ACM or in accordance with applicable regulations.
8. HEPA vacuum surface of flooring after carpet is removed. If residual asbestos-containing adhesive or residual felt backing needs to be removed, follow wet-scraping procedures in work practice R1 or R2, respectively. Allow substrate to dry before installing new flooring.

R8 . Level A ... continued

9. Use Work Practice M22 if HEPA vacuum needs maintenance, or if bag or filter needs to be replaced.
10. Perform clean-up and tear-down steps on Level A checklist to complete work.

R8 . Level B+

Remove carpet over resilient asbestos flooring

Example

The following is an example of work that can be performed using the procedures of this Level B+ work practice. If job conditions vary from the examples stop work and notify your supervisor.

- A. Remove carpet adhered to good condition resilient asbestos flooring where mastic and/or a small number full tiles may be pulled up, or flooring might be pulled up without separation of backing and wear layer. Resilient flooring mastic may or may not contain asbestos.

Notes

These procedures assume that the carpet adhesive or mastic does not contain asbestos, and that contamination is not present on the top side of the carpet. If a large area is involved, the work might require that abatement procedures be used. If carpet mastic contains asbestos, see Work Practice R1.

Review manufacturer's recommendation concerning installation of new carpet over old flooring and/or adhesive before proceeding with this work. If asbestos-containing adhesive must be removed, refer to wet-scraping procedures in Work Practice R1. Avoid foot traffic on any exposed mastic.

Work Practice

1. Perform Pre-work activities on Level B+ checklist.
2. Tools, equipment and materials:
 - a. Tools as needed from the lists in General Procedure W1
 - b. Scraper 2-3" (50-75 mm) wide stiff blade
 - c. Metal straightedge for use when cutting carpet
3. Complete Worker General Procedure W4 "Secure Work Area"
4. Place tools, equipment and materials needed into work area.
5. Find a seam or corner wherever carpet removal can begin. If no seams or corners exist, a cut will need to be made around the piece to be removed. Wet the areas that need to be cut using amended water. Cut carpet using utility knife with a new blade.
6. Pry up corner or seam of carpet using scraper. Pull back a section large enough (approximately one square foot [0.1 m²]) to hang onto while removing carpet. Adequately wet flooring and adhesive exposed.
7. Pull carpeting back slowly and spray amended water on flooring and adhesive as they are exposed. Remove carpet in pieces no larger than approximately 200 square feet (18.6 m²).
8. If carpet and adhesive are non-ACM, roll up carpet and dispose of as non-ACM waste. If portions of asbestos-containing flooring remain attached to carpet backing,

R8 . Level B+ ... continued

dispose of carpet as ACM. Loose vinyl asbestos flooring shall be disposed of in disposal bags or containers.

9. HEPA vacuum surface of flooring after carpet is removed. If residual asbestos-containing adhesive or residual felt backing needs to be removed, follow wet-scraping procedures in work practice R1 or R2, respectively. Allow substrate to dry before installing new flooring.
10. Perform clean-up and tear-down steps on Level B checklist to complete work.

Appendix F

Glossary

Acoustical Plaster Sound absorbing finishing material mill-formulated for application in areas where a reduction in sound reverberation or noise intensity is desired. These materials usually are applied in a minimum thickness of ½" (13 mm). The finish material is applied over gypsum plaster, plaster brown coat or other base plaster. The surface material is usually friable and has a rough surface appearance.

Acoustic Tile Tile-shaped blocks of sound absorbent material used for ceilings or as wall facing. May be glued to substrate or laid in a rigid grid work.

ACM (ACBM) Asbestos-Containing Material (Asbestos-containing Building Material). Any material containing more than one percent asbestos.

Adequately Wet Adequately Wet means sufficiently mix or penetrate with liquid to prevent the release of particulates. If visible emissions are observed coming from asbestos-containing material, then that material has not been adequately wetted. However, the absence of visible emissions is not sufficient evidence of being adequately wet.

AHERA Asbestos Hazard Emergency Response Act

AIA American Institute of Architects

Air Monitoring The process of measuring the fiber content of a specific volume of air.

Amended Water Water to which a surfactant has been added for use in wetting ACM to control asbestos fibers.

APM Asbestos Program Manager

Asbestos Chrysotile, amosite, crocidolite, tremolite asbestos,

anthophyllite asbestos, actinolite asbestos and any of these minerals that has been chemically treated and/or altered.

Asbestos-Containing Waste Material Mill tailings or any waste that contains commercial asbestos and is generated by a source regulated under NESHAP. This term includes filters from control devices, friable asbestos waste material, and bags or other similar packaging contaminated with commercial asbestos. As applied to demolition and renovation operations, this term also includes regulated asbestos-containing waste and materials contaminated with asbestos including disposable equipment and clothing.

Asbestos debris Pieces of ACBM that can be identified by color, texture, or composition, or means dust, if the dust is determined by an accredited inspector to be ACM.

Asbestos Hazard Emergency Response Act (AHERA) An EPA regulation published in the October 30, 1987 Federal Register covering asbestos-containing materials in schools. AHERA requires local education agencies to identify ACM in their school buildings, develop an asbestos management plan and implement this plan. An O&M program is one permitted response action, where appropriate.

Asbestos O&M Work Cleaning, maintenance, repair or renovation work involving asbestos containing materials where the intent of the activity is not to remove asbestos. NESHAP requires that the owner or operator of a demolition or renovation activity conduct a thorough inspection of the affected facility or part of the facility

where demolition or renovation will occur.

Asbestos Program Manager (APM) A building owner or designated representative who supervises all aspects of the facility asbestos management and control program.

Breathing Zone A hemisphere forward of the shoulders with a radius of approximately 6" to 9" (150-250 mm).

Bridging encapsulant An encapsulant that forms a discrete layer on the surface of an in situ asbestos matrix.

CFR Code of Federal Regulations

Clerk-of-the-works A representative of the architect or owner who oversees construction, handles administrative matters, and ensures that the construction is in accordance with the contract documents.

Competent Person means, in addition to the definition in 29 CFR 1926.32 (f), one who is capable of identifying existing asbestos hazards in the workplace and selecting the appropriate control strategy for asbestos exposure, who has the authority to take prompt corrective measures to eliminate them, as specified in 29 CFR 1926.32(f); in addition, for Class I and Class II work one who is specially trained in a training course which meets the criteria of EPA's Model Accreditation Plan (40 CFR part 763) for supervisor, or its equivalent and, for Class III and Class IV work, who is trained in a manner consistent with EPA requirements for training of local education agency maintenance and custodial staff as set forth at 40 CFR 763.92 (a)(2).

Compliance Instruction (Compliance Directive)

Instruction issued by OSHA to establish policies and provide clarification to ensure uniform enforcement of OSHA standards.

Concealed Suspension or Concealed Spline Ceiling System Presents a monolithic ceiling surface, unobstructed by the cross-hatching of exposed grid members. Tiles are typically 12" x 12" (300 x 300 mm) or 12" x 24" (300 x 600 mm) with slots or kerfs cut into the edges of tiles for the purposes of accepting flat or "T" splines to support the tiles.

Confined Space A space that has limited openings for entry and exit, unfavorable natural ventilation and/or a space not designed for continuous worker occupancy. Examples include boilers, furnaces, pits, septic tanks, manholes, silos and utility vaults.

Critical Barrier One or more layers of polyethylene taped in place over openings into a work area. Openings to be covered include doors, windows, diffusers, and any other opening that could allow outside air into a work area.

CSRF Construction Sciences Research Foundation

Decorative Acoustic Finish: Finishing material mill-formulated and spray applied up to about 3/8" (10 mm) thick over gypsum wallboard. Material has a rough surface and is similar in appearance to acoustic plaster but is not designed for sound absorption.

Delamination Separation of one layer from another.

Disposal Bag Properly labeled 6 mil (0.15 mm) thick (or thicker) leak-tight plastic bags used for transporting asbestos waste from work and to disposal site.

Drop Cloth A layer of polyethylene on the floor of a work area to protect the floor below from contamination and to facilitate the clean-up of dust or debris generated during the work.

EJCDC Engineers Joint Contract Documents Committee

EL See Excursion Limit

Encapsulant A material that surrounds or embeds asbestos fibers in an adhesive matrix, to prevent release of fibers.

Enclosure The construction of an air-tight, impermeable, permanent barrier around asbestos-containing material to control the release of asbestos fibers into the air.

EPA U.S. Environmental Protection Agency

Excursion Limit (EL) The OSHA term used to define a maximum airborne concentration of asbestos in fibers per cubic centimeter as averaged over a sampling period of thirty minutes.

Fiber Release Any uncontrolled or unintentional disturbance of ACBM resulting in visible emission.

Fireproofing Material applied to structural elements or systems which provides increased fire resistance, usually serving no structural function. This material is typically applied using spray equipment.

Friable Asbestos (See "Regulated ACM").

Glovebag A polyethylene or polyvinyl chloride bag-like enclosure affixed around an asbestos-containing source (most often, TSI) so that the material may be removed while minimizing release of airborne fibers to the surrounding atmosphere.

HEPA Filter High-Efficiency Particulate Air Filter. Such filters are rated to trap at least 99.97% of all particles 0.3 microns (0.3 μm) in diameter or larger.

HMR Hazardous Material Rules under Dept of Transportation regulations.

MAP EPA Interim Final Model Accreditation Plan (MAP) for asbestos

abatement worker training (40 CFR Part 763, Subpart E, Appendix C).

Medical Surveillance A periodic comprehensive review of a worker's health status. The required elements of an acceptable medical surveillance program are listed in the Occupational Safety and Health Administration standards for asbestos.

Mini-Enclosure An enclosure constructed of polyethylene sheeting used for small scale, short duration asbestos maintenance or renovation work. Mini-enclosures can be small enough to restrict entry to the asbestos work area to one worker. Appendix G to OSHA regulation 29 CFR 1926.58 discusses mini-enclosures and recommends that a change room be constructed contiguous to the mini-enclosure.

Miscellaneous ACM Interior asbestos-containing building material on structural components, structural members or fixtures, such as floor and ceiling tiles; does not include surfacing material or thermal system insulation.

NEA Negative Exposure Assessment

Negative Exposure

Assessment A demonstration by the employer which complies with criteria in paragraph (f)(2)(iii) of 29 CFR 1926.1101, that employee exposure during an operation is expected to be consistently below the PELs.

Negative Pressure System A local exhaust system intended to prevent the escape of contaminated air to the surrounding environment. It utilizes HEPA filtration capable of maintaining a pressure differential with a lower pressure inside the Work Area than in any adjacent area. This system recirculates clean air and/or generates a constant flow of air from adjacent areas into the work area.

Negative Pressure Respirator

A respirator in which the air pressure inside the respiratory-inlet covering is

positive during exhalation in relation to the air pressure of the outside atmosphere and negative during inhalation in relation to the air pressure of the outside atmosphere.

NESHAP National Emission Standard for Hazardous Air Pollutants - EPA Rules under the Clean Air Act (40 CFR Part 61).

NIOSH The National Institute for Occupational Safety and Health, which was established by the Occupational Safety and Health Act of 1970. Primary functions of NIOSH are to conduct research, issue technical information, and certify respirators.

O&M Operations & Maintenance Operations & Maintenance (O&M) Program A program of work practices to maintain ACM in good condition, ensure clean up of asbestos fibers previously released, and prevent further release by minimizing and controlling ACM disturbance or damage.

Occupied Area An area where personnel are present and are performing their normal activities intended for the area (such as in a typical office area from 8:00 to 5:00 p.m., Monday through Friday).

OSHA Occupational Health & Safety Administration.

PAPR Powered Air Purifying Respirator.

Penetrating Encapsulant An encapsulant that is absorbed by the in situ asbestos matrix without leaving a discrete surface layer.

PELs Permissible Exposure Limits.

Personal Air Samples An air sample taken with a sampling pump directly attached to the worker with the collecting filter and cassette placed in the worker's breathing zone. These samples are required by the OSHA asbestos standards and the EPA Worker Protection Rule.

PCM Phase Contrast Microscopy

Phase Contrast Microscopy (PCM)

A method of analysis using a light microscope, used to find the concentration of airborne fibers. Does not distinguish among asbestos and other fibers. Used by OSHA to find personal exposures, and by EPA to find area levels for AHERA project clearance.

Plenum Any space to convey air in a building or structure. The space above a suspended ceiling is often used as an air plenum. This term is also used in the work practices to refer to spaces above a ceiling not used to convey air.

PLM Polarized Light Microscopy Polarized Light Microscopy (PLM)

A method of analysis using a light microscope to find the chemical or mineral types of samples, including the concentration of asbestos in bulk materials. Used by EPA for AHERA and NESHAP, and by OSHA to see if asbestos is involved in a project.

Project Representative Architect's representative at the project site who assists in the administration of the construction contract.

Protection Factor The ratio of the ambient concentration of an airborne substance to the concentration of the substance inside the respirator at the breathing zone of the wearer. The protection factor is a measure of the degree of protection provided by a respirator to the wearer.

RCRA Resource Conservation and Recovery Act.

RACM Regulated ACM

Regulated ACM (RACM) As defined by NESHAP in the November 20, 1990 Federal Register, **regulated asbestos-containing material (RACM)** means (a) Friable asbestos material, (b) Category I nonfriable ACM that has become friable, (c) Category I nonfriable ACM that will be or has been subjected to sanding, grinding, cutting, or abrading, or (d)

Category II nonfriable ACM that has a high probability of becoming or has become crumbled, pulverized, or reduced to powder by the forces expected to act on the material in the course of demolition or renovation operations regulated by this subpart.

(Note: Regulated ACM is an EPA NESHAP concept. OSHA makes no distinction between friable and non-friable asbestos).

"Cutting" means to penetrate with a sharp-edged instrument and includes sawing, but does not include shearing, slicing or punching.

"Grinding" means to reduce powder or small fragments and includes mechanical clipping or drilling.

Friable asbestos material means any material containing more than 1 percent asbestos as determined using the method specified under AHERA (40 CFR Part 763, Sub-part F, Appendix A, section 1, Polarized Light Microscopy) that, when dry, can be crumbled, pulverized, or reduced to powder by hand pressure. If the asbestos content is less than 10 percent as determined by a method other than point counting by polarized light microscopy (PLM), verify the as-bestos content by point counting using PLM.

Category I nonfriable asbestos-containing material (ACM) means asbestos-containing packings, gaskets, resilient floor covering and asphalt roofing products containing more than 1 percent asbestos as determined using the method specified under AHERA.

Category II nonfriable ACM means any material, excluding Category I nonfriable ACM, containing more than 1 percent asbestos as determined using the methods specified under AHERA,

when dry, cannot be crumbled, pulverized, or reduced to powder by hand pressure.

Remove For Operations and Maintenance work on ACM, "remove" refers to the removal of ACM as needed to perform a maintenance or repair O & M activity.

Removal Encapsulant A penetrating encapsulant specifically designed to minimize fiber release during removal of asbestos-containing materials rather than for in situ encapsulation.

Repair Returning damaged ACBM to an undamaged condition or to an intact state so as to prevent fiber release.

Respirator A device designed to protect the wearer from the inhalation of harmful particulates.

Small-scale, Short-duration Term formerly used by OSHA to describe O&M work activities (in the previous OSHA construction standard). This term has been superceded by the work class definitions in the current OSHA standard.

Surfacing ACM Asbestos-containing material that is sprayed-on, troweled-on or otherwise applied to surfaces, such as acoustical plaster on ceilings and fireproofing materials on structural member, or other materials on surfaces for acoustical, fireproofing, or other purposes.

Survey An asbestos survey is what EPA calls an inspection in the AHERA regulation. It consists of a visual and tactile inspection of a building to identify, quantify and assess the accessibility and condition of the ACM and suspected ACM present.

Suspended "T" Bar Ceiling System A false or dropped ceiling composed of acoustic tiles laid into an inverted metal "T" bar grid frame suspended by wires from building framing members.

Surfactant A chemical wetting agent added to water to improve penetration, thus reducing the quantity of water required for a given operation or area.

TEM Transmission Electron Microscopy

Temporary Barriers One or more layers of 6 mil polyethylene installed to isolate a work area from other portions of a facility.

Thermal System Insulation

(TSI) Thermal system insulation - asbestos-containing material applied to pipes, fittings, boilers, breeching, tanks, ducts or other interior structural components to prevent heat loss or gain or water condensation.

Time Weighted Average (TWA)

In air sampling, this refers to the average air concentration of contaminants during a particular time period.

TSI Thermal System Insulation

Transmission Electron

Microscopy (TEM) A method of analysis using an electron microscope, used to find and analyze the concentration of airborne or bulk asbestos fibers and structures.

Distinguishes among asbestos and other materials; can detect smaller asbestos fibers than does PCM. Used by EPA to find area concentrations for large AHERA project clearance.

TSCA Toxic Substances Control Act

TWA Time Weighted Average.

Work Area The area where asbestos-related work or removal operations are performed which is defined and/or isolated to prevent the spread of asbestos dust, fibers or debris, and entry by unauthorized personnel.

Work Practices Procedures designed to be followed to avoid or minimize fiber release during activities affecting ACM.

Appendix G

References

EPA Regulations

United States Environmental Protection Agency, Asbestos Abatement Projects; Worker Protection; Final Rule ("Worker Protection Rule") 40 CFR 763.120-126, Washington D.C., 1987.

United States Environmental Protection Agency, National Emission Standards for Hazardous Air Pollutants (NESHAP) 40 CFR 61.140-157, Washington D.C., 1984, revised 1990.

United States Environmental Protection Agency, Asbestos-Containing Materials in Schools; Final Rule and Notice (Asbestos Hazard Emergency Response Act - AHERA) 40 CFR 763.80-99, Washington D.C., 1987.

United States Environmental Protection Agency, Interim Final Model Accreditation Plan (MAP) for asbestos abatement worker training (40 CFR Part 763, Subpart E, Appendix C).

EPA Guidance Documents

(Order by Calling TSCA Assistance Hotline in Washington, DC at: (202) 554-1404).

United States Environmental Protection Agency, Managing Asbestos in Place ("Green Book") EPA Publication #20T-2003, Washington D.C., 1990.

United States Environmental Protection Agency, Guidance for Controlling Asbestos-Containing Materials in Buildings ("Purple Book") EPA publication #560/5-85-024, Washington D.C., 1985.

United States Environmental Protection Agency, A Guide to Respiratory Protection for the Asbestos Abatement Industry ("White Book") EPA publication #560-OPTS-86-001, Washington D.C., 1986.

United States Environmental Protection Agency, Simplified Sampling scheme for Surfacing Materials (Pink Book") EPA publication #560/5-85-030a, Washington D.C., 1985.

United States Environmental Protection Agency, EPA Guidance for Service and Maintenance Personnel, EPA publication #560/5-85-018, Washington D.C., 1985.

United States Environmental Protection Agency, Model training course materials for accrediting Asbestos Building Inspectors and Management Planners in accordance with AHERA, Washington D.C., 1987.

United States Environmental Protection Agency, Abatement of Asbestos-Containing Pipe Insulation, Asbestos-in-Buildings Technical Bulletin 1986-2, Washington D.C., 1986.

**OSHA
Regulations**

Occupational Safety and Health Administration, Asbestos Regulations for the Construction Industry 29 CFR 1926.58, Washington D.C., 1986.

Occupational Safety and Health Administration, Respiratory Protection for the Construction Industry 29 CFR 1926.103, Washington, D.C., 1970.

Occupational Safety and Health Administration, Respiratory Protection for General Industry 29 CFR 1910.134, Washington, D.C., 1978.

Occupational Safety and Health Administration, Hazard Communication Standard for the Construction Industry 29 CFR 1926.59, Washington D.C., 1987.

**U.S. General
Services
Administration
(PMSE)**

Documentation Package for Asbestos Operations & Maintenance Programs, Washington D.C., 1990.

**Asbestos
Information
Center**

(Air monitoring guidance, etc.)

**Miscellaneous
References**

Institute for Environmental Assessment, 433 Jackson Street, Anoka, MN 55303:

1. Suggested Operations and Maintenance Procedures
2. Guide to Asbestos Personal Monitoring
3. Recognition of Damage, Deterioration and Delamination
4. Aerodynamic Characteristics of Asbestos

Keyes, Dale L. and Chesson, Jean. Guide to Monitoring Airborne Asbestos in Buildings, Tuscon, AZ, 1989.

Health Effects Institute - Asbestos Research, Asbestos in Public and Commercial Buildings A Literature Review and Synthesis of Current Knowledge, Cambridge, MA, 1991.

O&M Program Element References

Element	Regulations & Guidance Documents	Green Book Guidance
APM Appointment & Training	Purple Book, AHERA, White Book	Pgs. 7 & 23 - 25
Worker Training	Purple Book, AHERA, White Book, OSHA 29 CFR 1926.1101, OSHA Instruction CPL 2-2.63 dtd Nov 3, 1995	Pgs. 23 - 25
Work Practices	AHERA, OSHA 29 CFR 1910.1001; 1926.1101; OSHA Instruction CPL 2-2.63 dtd Nov 3, 1995	Pgs 16 - 21
Building Inspection & Assessment	Purple Book, AHERA, Pink Book, OSHA 29 CFR 1910.1001, 1926.1101, OSHA Instruction CPL 2-2.63 dtd Nov 3, 1995	Pg. 7
Occupant Notification & Communication	AHERA, OSHA 29 CFR 1910.1001, 1926.1101, OSHA Instruction CPL 2-2.63 dtd Nov 3, 1995	Pgs. 12 - 13, 28 - 29
Hazard Communication Program	OSHA 29 CFR 1910.1200, 1926.59, OSHA Instruction CPL 2-2.63 dtd Nov 3, 1995	Pg. 22
Worker Exposure Monitoring	OSHA 29 CFR 1910.1001, 1926.1101, OSHA Instruction CPL 2-2.63 dtd Nov 3, 1995	Pgs. 17 - 18, 38
Respiratory Protection Program	White Book, OSHA 29 CFR 1910.1001, 1910.134, 1926.1101, OSHA Instruction CPL 2-2.63 dtd Nov 3, 1995	Pgs. 17 - 18
Medical Surveillance	OSHA 29 CFR 1910.1001, 1926.1101, OSHA Instruction CPL 2-2.63 dtd Nov 3, 1995	Pg. 27
Work Permit System	-----	Pg. 15
Waste Disposal	EPA NESHAP 40 CFR 61.145,150 OSHA 29 CFR 1910.1200, DOT 49 CFR Parts 171 & 180.	Pg. 28
Recordkeeping	AHERA, OSHA 29 CFR 1910.1001, 1926.1101, OSHA Instruction CPL 2-2.63 dtd Nov 3, 1995	Pg. 22
Fiber Releases	Purple Book, AHERA	Pgs. 20 - 21
Periodic Surveillance & Reinspections	Purple Book, AHERA	Pg. 14
Air Monitoring	Purple Book, AHERA OSHA 29 CFR 1910.1001, 1926.1101, OSHA Instruction CPL 2-2.63 dtd Nov 3, 1995	Pgs. 10, 14 - 15
Confined Spaces	OSHA 29 CFR 1910.1001, 1915.1001, 1926.1101	-----
General Safety Hazards	White Book Appendix D OSHA 29 CFR Part 1926	-----

Appendix H

General Safety Considerations

(This section is reprinted from Appendix D of the EPA's White Book for use by personnel performing O & M activities.)

Ronald L. Stanevich
NIOSH Division of Safety Research

This guide was primarily developed to provide recommendations concerning worker respiratory protection within the asbestos abatement industry. However, employers must not lose sight of the safety hazards their employees are exposed to in performance of their work. Asbestos abatement operations can take place in a variety of industrial, commercial and public settings. Each has unique potential safety hazards that the employer must control. However, nearly all abatement operations have some common safety hazards. With proper job planning and supervision, the employer can control both the health hazards and the safety hazards faced by their workers. The more common safety hazards associated with abatement operations and general recommendations to control them are discussed below. Sources for more specific safety information are listed to supplement and support the applicable OSHA regulatory standards.

I. Elevated Work Surfaces

The nature of asbestos abatement tasks usually requires workers to work from ladders, scaffolds, manlifts, or other elevated surfaces, which creates the potential for fall injuries. Slips and falls from ladders, scaffolds, and other elevated surfaces result in a major portion of the construction industry injuries. Many of these can be prevented by implementing a few control measures:

A. General

- (1) Avoid use of makeshift work platforms by providing portable ladders and scaffolds.
- (2) Ensure that job-built elevated work surfaces are inspected by a competent person other than the individual who erects it.
- (3) Avoid working from elevated surfaces where possible. Consider use of wands for spraying amended water or scrapers with extended handles.

B. Ladders

Eighty percent of ladder-related accidents result from improper use or application.

- (1) Workers should face the ladder when climbing up, down, or working from it.
- (2) Workers should not carry objects in their hands while ascending or descending ladders. While working from a ladder they should hold on with at least one hand.
- (3) Ladders should not be used as a substitute for planks, runways, or walkboards.
- (4) Ladders should be maintained in good condition. Defective ladders should be destroyed so that no one uses them by mistake.
- (5) Ladders should have safety feet in good condition to keep the ladder from slipping and cutting through polyethylene floor covers.

- (6) Ladder rungs/steps should be kept free of contaminants such as amended water and buildup of asbestos waste.
- (7) Employees should work no higher than the fourth step/rung from the top of the ladder.
- (8) Employees should not attempt to "reach" distant objects from a ladder; other platforms should be used.
- (9) Wood or fiberglass ladders should be provided to help control exposure to electrical hazards.
- (10) Employees Should not straddle the space between a ladder and another object.
- (11) Employees should make a visual inspection of ladders before each shift.

Additional information sources:

Ladders -- publication no. ISBN 0-919465-05-6
 Construction Safety Association of Ontario
 74 Victoria Street
 Toronto, Ontario Canada M5C 2A5

Safety Requirements for Portable Wood Ladders -- ANSI A14.1 - 1982
Safety Requirements for Job-Made Ladders -- ANSI A14.4 - 1979
Safety Requirements for Portable Reinforced Plastic Ladders -- ANSI
 A14.5 - 1982
 American National Standards Institute, Inc.
 1430 Broadway
 New York, NY 10018

Portable Ladders -- Industrial Safety Data Sheet #665
 National Safety Council
 444 North Michigan Avenue
 Chicago Illinois 60611

Environmental Health and Safety Division
 Georgia Tech Research Institute
 Georgia Institute of Technology
 Atlanta, Georgia 30332

C. Scaffolds

Falls from scaffolds result in about 2,000 injuries per month in the United States. These can be reduced by

- (1) providing guardrails around the perimeter of the work surface regardless of scaffold height
- (2) securing scaffold decks against slippage
- (3) keeping scaffold uprights vertical and pinned together when stacked
- (4) ensuring vertical members are braced to keep the scaffold plumb and level
- (5) decking the entire top portion of the work surface in lieu of using minimum planking dimensions
- (6) extending planks at least 6" (150 mm) over their support and cleating or restraining them from movement
- (7) ensuring that manufacturer built-in ladders are in good condition
- (8) maintaining mobile scaffold casters in good condition with position locking devices secured when employees are working from the scaffold

- (9) keeping mobile scaffolding height less than four times the minimum base dimension and with adequate cross-bracing
- (10) never interchanging scaffolding pans from different units
- (11) never using defective scaffolding
- (12) designating only "Competent" persons to perform scaffolding repairs.

Additional information sources:

Manually Propelled Mobile Ladder Stands and Scaffolds"

ANSI A92.1 - 1977

Manually Propelled Elevating Work Platforms – ANSI A92.3 - 1980

Self-Propelled Elevating Work Platforms -- ANSI A92.6

American National Standards Institute, Inc.

1430 Broadway

New York, NY 10018

II. Electrical Hazards

Asbestos abatement is often related to renovation or remodeling activities. Normally the equipment, machinery, overhead lighting fixtures, and auxiliary furnishings are removed to facilitate the abatement work. However, it is becoming more common that industrial and commercial buildings remain partially occupied while abatement operations are performed. In either situation, the abatement operator must take positive actions to protect employees from accidentally coming into contact with energized electrical circuits.

A. General

- (1) Perform a pre-work walk-through of the abatement area to look for pre-existing electrical hazards involved with the work.
- (2) De-energize as many circuits as possible.
- (3) Verify that the circuits have been de-energized with a "Field Current Sensing Device" circuit tester. Either lock out/tag out all de-energized circuits to prevent them from accidentally being energized.
- (4) Use non-conductive tools such as scrapers and vacuum attachments made of wood, plastic, or rubber.
- (5) Provide workers with non-conductive rubber boots and/or gloves when work must be done around energized wiring or equipment.
- (6) Prohibit accumulation of puddles of water on the floor. Workers should be trained in the intelligent use of amended water. No water should be used around energized circuits.

B. Permanent Building Circuitry

- (1) Ensure that all permanent circuits are provided with a grounding system. This can be determined with a portable ground tester.
- (2) Ensure that electrical outlets are tightly sealed and taped to avoid water spray.
- (3) Determine what equipment must remain energized during the abatement process.
- (4) Insulate or guard energized equipment and Wiring from employee contact and other conductive objects.
- (5) Avoid damaging permanent building wiring during the work.
- (6) Consider dry removal methods in the vicinity of electrical equipment which must remain energized.

C. Temporary Power

- (1) All temporary circuits provided by the abatement operator must be provided with a grounding system and protected by ground fault circuit interrupters.
- (2) Avoid stringing temporary wiring across floors
- (3) Elevated wiring should not be fastened with staples, nails, or wire.
- (4) Use care not to damage the wiring insulation during Installation or abatement work.

D. Electrical Cords and Tools

- (1) Provide extension cords which have a ground conductor.
- (2) Ensure that cords are not damaged, contain no splices, and that the grounding lug on the male plug is intact.
- (3) Position extension cords to eliminate stumbling/tripping hazards and to protect them from damage by moving scaffolds.
- (4) Provide electrical tools which are either grounded or of the double-insulated type
- (5) Use shatterproof, guarded bulbs and heavy duty wiring for temporary lighting.
- (6) Where plugs enter receptacles, ensure that the connection is protected by use of duct tape or by other means.

Additional information sources:

National Electrical Safety Code -- ANSI C2-1984
National Electrical Code -- ANSI/NFPA 70-1984
American National Standards Institute, Inc.
1430 Broadway
New York, NY 10018

Temporary Electric Wiring for Construction Sites -- Industrial Safety
Data Sheet #515
National Safety Council
444 North Michigan Avenue
Chicago, Illinois 60611

III. Housekeeping

Asbestos abatement operations present continuous housekeeping problems. The accumulation of asbestos and other debris on polyethylene-covered floors create employee slipping and tripping hazards. It is essential that accumulation of such debris be bagged and removed from the floor as soon as possible. Even though this activity may initially require more effort, it will make final cleanup easier and the work area safer.

Additional information source:

Supervisors Safety Manual
National Safety Council
444 North Michigan Avenue
Chicago, Illinois 60611

IV. Emergency Planning

The abatement operator should develop emergency procedures for fires or severely injured employees. Since abatement work areas must be sealed off, thereby blocking normal exits, the operator must familiarize the workers with procedures for safe exit in case of fire. Furthermore, the operator should develop plans for obtaining emergency aid in case of

severe employee injury. The plans should be compatible with decontamination procedures yet provide for quick medical aid.

Additional information source:

Environmental Health and Safety Division
Georgia Tech Research Institute
Georgia Institute of Technology
Atlanta, Georgia 30332

APPENDIX I:

FEDERAL OCCUPATIONAL AND ENVIRONMENTAL REGULATIONS, STANDARDS AND GUIDELINES

This Appendix describes the principal federal regulations, standards and guidelines governing occupational and environmental exposures to asbestos, as of the date of this publication. A number of other federal occupational and environmental standards also apply to operations within the scope of this Manual and the reader should be familiar with those requirements as well. It is also important to note that state and local regulations may have requirements that differ from federal regulations and some may be more stringent than the federal regulations described in this Appendix.

THE OCCUPATIONAL SAFETY AND HEALTH ACT:

OSHA Asbestos in Construction Standard (29 CFR 1926.1101)	427
OSHA Asbestos in General Industry Standard (1910.1001)	443
OSHA Hazard Communication Standard (1926.59)	445
Head Protection (1926.100)	446
Hearing Protection (1926.101)	446
Eye and Face Protection (1926.102)	446
Respiratory Protection (1926.103)	446
Safety Belts, Lifelines, and Lanyards (1926.104)	447
OSHA Fire Protection and Prevention (1926.150)	447
OSHA Disposal of Waste Material (1926.252)	448
OSHA Lockout and Tagging of Circuits (1926.417)	448
OSHA Scaffolding (1926.451)	449
OSHA Grounding for Protection of Employees (1926.954)	450

ENVIRONMENTAL PROTECTION AGENCY:

EPA Asbestos Hazard Emergency Response Act (AHERA)	451
EPA Asbestos School Hazard Abatement Reauthorization Act (ASHARA)	453
EPA Asbestos NESHAP (40 CFR 61.140-157)	453

DEPARTMENT OF TRANSPORTATION:

DOT Hazardous Material Rules	459
------------------------------------	-----

THE OCCUPATIONAL SAFETY AND HEALTH ACT

The federal Occupational Safety and Health Act (OSH Act) is the primary source of regulation of an employer's obligation to provide a safe and healthful workplace. The OSH Act (1) requires that each employer comply with the occupational safety and health standards issued by OSHA; and (2), even in the absence of any specific standard, the Act also imposes a general duty on each employer to provide a workplace that is free from recognized hazards that are causing or are likely to cause death or serious physical harm to employees.

Public sector workers in states with their own OSHA programs can have standards equal to or more stringent than OSHA. The EPA "Asbestos Abatement Projects: Worker Protection Rule," (40 CFR 763, Sub-part G) extends similar protection to publicly employed workers involved in asbestos abatement work. For schools, the AHERA regulation (40 CFR 763, Sub-part E) sets forth training requirements for abatement, custodial and O&M workers and describes work practices for O&M work. The Asbestos in Schools Hazard Abatement Re-authorization Act (ASHARA) regulation extended these training requirements to all public and commercial buildings.

OSHA has developed three specific standards governing exposure to asbestos in the workplace: the construction standard, the shipyard standard, and the general industry standard. In addition to these, this Appendix also briefly describes other OSHA standards of more general applicability, as well as EPA and DOT regulations that apply to asbestos.

Major revisions to asbestos-specific standards were published in the Federal Register on August 10, 1994, and additional changes were published on June 29, July 13, and September 29, 1995. In addition, OSHA has issued a compliance directive regarding these revisions, Instruction CPL 2-2.63 dated November 3, 1995. The discussion includes all changes made as of the date of publication. The reader should verify whether additional changes have been made as of the time of use.

OSHA:

ASBESTOS IN CONSTRUCTION STANDARD

(29 CFR 1926.1101)

The new standard, 29 CFR 1926.1101, replaces the previous one, 29 CFR 1926.58.

Scope and application

Most activities within the scope of this Manual are subject to the asbestos in construction standard, which covers all construction activities performed by employees, regardless of the primary activity of the employer; see paragraph (a)(7) of the standard. For example, maintenance or removal of an asbestos-containing gasket, even if performed in an industrial plant, by the employer's own maintenance staff, is covered under the construction standard. 1926.1101 regulates asbestos exposure in all work as defined in 29 CFR 1910.12(b), including but not limited to the following:

- Demolition or salvage of structures where asbestos is present;
- Removal or encapsulation of materials containing asbestos;
- Construction, alteration, repair, maintenance, or renovation of structures, substrates, or portions

thereof, that contain asbestos;

- Installation of products containing asbestos;
- Asbestos spill/emergency cleanup; and
- Transportation, disposal, storage, containment of and housekeeping activities involving asbestos or products containing asbestos, on the site or location at which construction activities are performed.
- Coverage under the OSHA standard is based on the nature of the work operation involving asbestos exposure.

Examples of work falling outside the scope of the construction standard are: general housekeeping in industrial and commercial operations where asbestos may be contacted but not disturbed, and brake and clutch repair (general industry standard); and asbestos-related activities in shipyards (shipyard standard).

Definitions

The OSHA standard should be consulted for a complete listing of definitions. The following are selected definitions useful for this summary, but no more inherently important for OSHA compliance than others.

Asbestos-containing material: The OSHA standard defines both asbestos-containing materials (ACM) and presumed asbestos-containing material (PACM). Thermal system insulation and

surfacing material in buildings constructed no later than 1980 are treated as ACM unless it is proven that they are not.

- **Asbestos-containing material (ACM):** means any material containing more than one percent asbestos.
- **Presumed Asbestos Containing Material:** means thermal system

insulation (TSI) and surfacing material found in buildings constructed no later than 1980. The designation of a material as "PACM" may be rebutted pursuant to paragraph (k)(5) of this section.

Asbestos work: The OSHA construction standard establishes four categories or classes of asbestos work.

- **Class I** asbestos work means activities involving the removal of thermal system insulation (TSI) and surfacing asbestos-containing material (ACM) or presumed asbestos-containing material (PACM) and includes picking up and bagging asbestos debris/dust during Class I work. (In general this involves work on friable materials.)
- **Class II** asbestos work means activities involving the removal of asbestos-containing material (ACM) that is not TSI or surfacing material and includes picking up and bagging asbestos debris/dust during Class II work. This includes, but is not limited to, the removal of asbestos-containing wallboard, floor tile and sheeting, roofing and siding shingles, and construction mastics. (In general, this involves work on non-friable materials if the material is removed in a substantially intact state.)
- **Class III** asbestos work means repair and maintenance operations where ACM, including TSI and surfacing ACM and PACM may be disturbed and includes picking up and bagging asbestos debris/dust during Class III work. (This is O&M work that generates no more than a single disposal bag of waste filled only 1/3 to 1/2 full.)
- **Class IV** asbestos work means maintenance and custodial activities during which employees contact, but do not disturb, ACM or PACM. Class

IV activities also include clean-up work that takes place in an area after a Class I, II, or III job (including all clean-up and bagging of asbestos-containing waste) has been completed. Class IV clean-up encompasses precautionary measures to be taken to avoid exposures in the event there is residual dust/debris present in the work area. In the event that residual dust or debris is found in the Class IV work area, a competent person must assess the area and decide whether the clean-up work should be performed as a Class I, II, or III operation. Class IV requires only awareness training. However, the EPA Model Accreditation Program requires accredited abatement workers for Class I and II clean-up where the work has made the material friable. All workers in a Class I, II or III work area should have the training required for that class of work. Workers should wear respirators if cleaning up a regulated area where respirators are required.

Some asbestos related work does not fall within a class; examples include encapsulation (a)(2) and installation of ACM (a)(4), but are covered by certain provisions of the standards.

Disturbance: means activities that disrupt the matrix of ACM or PACM, crumble or pulverize ACM or PACM, or generate visible debris from ACM or PACM. Disturbance includes cutting away small amounts of ACM and PACM, no greater than the amount which can be contained in one standard sized glove bag or waste bag in order to access a building component. In no event shall the amount of ACM or PACM so disturbed exceed that which can be contained in one glove bag or waste bag which shall not exceed 60 inches in length and width.

Multi-employer worksites

On multi-employer worksites, the employer (abatement contractor) involved in Class I, II or III asbestos control work is required to

- notify other employers of the nature of work being performed and requirements for regulated areas,
- abate any asbestos contamination caused by their work.

Other employers on the site (such as other contractors including the General Contractor) are responsible for

- protecting their workers in accordance

with OSHA requirements, and

- ascertaining the integrity of the abatement contractor's enclosure and effectiveness of the control methods being used.

A general contractor on a construction project which includes abatement work is considered to have general supervisory authority over the abatement work even if not qualified to serve as the asbestos "competent person," and must require the abatement contractor to come into compliance with the OSHA standard when necessary.

Regulated areas

A regulated area is required for all Class I, II and III work, any area where waste and debris for asbestos work is accumulated, and any adjoining area where the PEL may be exceeded. See the section in this appendix on "Requirements for Individual Classes of Work" for discussions on regulated areas for different classes of work.

- The regulated area must be demarcated,
- access to the area must be limited to authorized persons,

- respirators must be used if required,
- certain activities are prohibited (eating, drinking, smoking, chewing tobacco or gum, and applying cosmetics^a), and
- a competent person must supervise work performed in the area.

a. In a January 13, 1995 memo from the Director of Directorate of Compliance Programs to Regional Administrators, OSHA has stated that it will not issue citations for "eating, drinking, chewing tobacco or gum, and applying cosmetics in a regulated area unless worker exposure exceeds the PEL."

Permissible exposure limits (PELs)

The OSHA regulation sets two permissible exposure limits (PELs) expressed in fibers per cubic centimeter (f/cc).

The Permissible Exposure Limits (PELs) are

- 0.1 f/cc based upon the average exposure for a complete 8 hour work

shift, referred to as the 8 hour Time Weighted Average (TWA).

- The Excursion Limit (EL) of 1.0 f/cc is for a 30 minute TWA, to address peak exposures a worker may experience.

In addition to requirements which apply at any exposure level, a number of requirements are triggered if either the

PEL or EL are exceeded including ones for respiratory protection and protective clothing and a regulated area (See discussion above on regulated areas).

OSHA uses, "exceeding the PEL," or, "exceeding the PELs," to mean,

"exceeding either the 8-hour permissible exposure limit (PEL) or the excursion limit (EL)."

OSHA requires controls based on the kind of operation regardless of the measures exposure levels.

Requirements at any Exposure Level

The following provisions apply to any activity covered under the standard, regardless of measured exposure levels.

General

• Exposure assessments and monitoring (f):

- Initial exposure assessment by a "competent Person" (f)(2). (See below for competent person requirements and duties.)
- Negative exposure assessments (NEA) can be obtained from the initial assessment, objective data, or historical data taken by the employer on previous jobs within the past twelve months, under conditions closely resembling the current work, and which provide a high degree of certainty that neither the time weighted average (TWA) nor the excursion limit (EL) will be exceeded (f)(2)(iii). A special NEA rule for removals of resilient flooring is explained in flooring section under Class II activities. Relevant historic data factors include: processes, type and condition of material, work practices used, and the level of training and experience of the workers.
- Additional monitoring needed when work changes or other reason new or additional exposures above a PEL may occur.
- Employees and their representatives can observe monitoring (f)(6).

-- Employer must notify employee of monitoring results(f)(5).

• Multi-employer worksites (d):

- Employers establishing regulated areas must tell other employers on the site of the nature of the asbestos work, regulated area requirements, and control measures used (d)(1).
- Breaches and hazards are the responsibility of the employer who created or controls the contamination (d)(2).
- All employers must take applicable protective measures, e.g., relocation, even if they did not cause the exposure (d)(3).
- Employers with workers next to the regulated area of another employer must check controls' effectiveness daily (d)(4).
- General contractors must ensure that all subcontractors comply with the standard (d)(5).

Controls

• Engineering controls and work practices must include (g)(1):

- HEPA vacuums(except for some roofing operations; see below under Class II).
- Wet methods (except where infeasible or create a safety hazard; or for certain removal of roofing or

resilient flooring [see Class II discussions, below]).

- Prompt clean-up and disposal.
- Prohibited work practices and engineering controls (g)(3):
 - High-speed abrasive disc saws.
 - Compressed air to remove asbestos (unless in enclosed ventilation system).
 - Dry sweeping or shoveling.
 - Employee rotation to reduce exposure.
- When vacuuming is used for housekeeping on construction projects, HEPA vacuums must be used; and used and emptied so as to minimize asbestos dispersal (l)(1).
- Waste, debris and accompanying dust in an area with accessible TSI or surfacing ACM/PACM or visibly deteriorated ACM shall be promptly cleaned up using wet dusting or sweeping, or HEPA vacuuming, and disposed of in leak tight containers (l)(4) (see Class II discussion of roofing operations).
- Medical monitoring (m):
 - Medical surveillance is required for workers engaged in Class I, II or III work, or exposed at or above the PEL, for a combined total of 30 or more days a year (any day in which a worker engages in Class II or III operations or a combination thereof on intact material for one hour or less, including removal and cleanup, and fully adheres to the work practices in the standard, shall not be counted). Medical examinations' frequency, content, and information given to and by the physician shall follow the standard. A medical examination is also required before a worker may be assigned to any job where a respirator is required (h)(3)(iv) and 29 CFR 1926.103. The General Industry standard

requires medical monitoring for any employee exposed at or above the PEL on any day.

- Employers shall ensure that employees required to wear a negative pressure respirator are determined, at no cost to them, and under the supervision of a physician, to be physically able to perform the work and use the respirator (h)(3)(iv) and (m)(1)(I)(B).
- Procedures are specified for: 1. resilient flooring maintenance in connection with construction work (l)(3), and 2. dust and debris cleanup in areas containing accessible thermal system insulation or surfacing ACM/PACM or visibly deteriorated ACM (l)(4).

Identification of Materials

- Building/facility owner (which includes a lessee) must determine the presence, location and quantity of ACM and/or presumed asbestos-containing materials (PACM) at the work site before beginning any work subject to the standard (k)(2)(I).
- Presume or inspect surfacing, thermal system insulation (TSI), or resilient flooring material at work site (k)(1):
 - TSI and sprayed-on or troweled-on surfacing materials in buildings or substrates constructed before 1980 are PACM; resilient flooring material installed before 1980 is also presumed to be ACM, although the term "PACM" is not used for it (k). Can rebut presumptions:
 - For PACM, an AHERA inspection, or testing of the material being worked on by an AHERA-accredited inspector or a Certified Industrial Hygienist, is required; a nationally recognized testing program (National Voluntary Laboratory

Accreditation Program [NVLAP] or equivalent) must be used for analysis (k)(5)(ii).

- For resilient flooring material, an industrial hygienist must use recognized analytical techniques (k)(5)(iii).

Communication

- The building/facility owner must notify, in writing or personally, the presence, location and quantity of ACM or PACM at the work sites to (k)(2)(ii):
 - Prospective employers whose employees will work in or next to areas with ACM or PACM.
 - Owner's employees who will work in or next to such areas.
 - All employers on multi-employer worksites whose employees will work in or next to such areas.
 - Tenants who will occupy such areas.
- Before work begins, the employer must inform the building/facility owner, its own employees, and other employers whose employees will work in or next to the area, of the presence, location and quantity of ACM and/or PACM, and precautions to be used (k)(3)(ii). For work within a regulated area, the employer must also inform other employers of the nature of the work and regulated area requirements (d)(1).
- The employer shall, if asked, make available for examination and copying:
 - All records required to be maintained, to OSHA and NIOSH;
 - all required exposure records, to affected current and former employees, their designated representatives, and OSHA; and
 - required employee medical records,

to the employee, and person with the employee's written consent, and OSHA (n)(7).

- By 10 days after completion of work, the employer must inform the building/facility owner, its employees, and other employers whose employees work or will work in the area, of the current location and quantity of PACM and/or ACM remaining, and any final monitoring results (l)(3)(iii).
- Within 24 hours of discovery, the employer must inform the building/facility owner and other employers whose employees work in the area, of the presence, location and quantity of newly discovered ACM and/or PACM (k)(4).
- The employer and building/facility owner must identify PACM as ACM in communications to employees, and treat as ACM materials they know or should have known through the exercise of due diligence to be ACM (k)(1).

Warning Signs and Labels

- Signs at entrance to regulated areas (k)(7).
- Signs at entrance to mechanical rooms/areas with ACM or PACM (k)(6). Signs can be on outside of entrance or inside room if visible to people entering (Compliance Directive, p. C-36).
- Labels must be placed on products containing asbestos, including waste containers and, where feasible, installed products, unless asbestos fibers are bound so that no foreseeable work will release them above PEL or EL, or when less than 1% (k)(8).
- Employers/building owners must post or affix signs or labels with respect to all ACM or PACM (k)(8)(vii). Signs required by (k)(6) may be posted in lieu of labels so long as they contain

information required for labeling.

- Signs and labels must be comprehensible to non-English speaking employees (k)(7).

Training

- Employers must train employees in recognizing and avoiding unsafe conditions, applicable regulations, the potential hazards, safe handling and use of harmful or toxic substances, and personal hygiene and personal protective measures required (29 CFR 1926.21(b)).
- Employers must train all employees doing Class I-IV work, and asbestos product installers, before or at initial assignment and then at least annually (k)(9)(i)-(ii).
- Any training done must be in a manner employee is able to understand (e.g., language) and must take place with a knowledgeable instructor present (k)(9)(viii).
- Employer must make readily available at no cost to employees, written materials on the employee training program, and inform them about, and provide if asked, approved self-help smoking cessation program material; and give OSHA and NIOSH all employee information and training program materials if asked (k)(10).
- Minimum training requirements for each Class are outlined later in this appendix.

Record Retention

- Exposure monitoring records, including those for a negative exposure assessment (NEA) based on current or historical data: 30 years (n)(2).
Records based on objective data; while

employer relies on data (n)(1).

Exposure measurements may be kept by either the employer or competent organizations, e.g., trade or employee groups (n)(2).

- Medical surveillance records:
Employment plus 30 years (n)(3).
- Training records: Employment plus one year (n)(4).
- Data to rebut PACM: While employer relies on data (n)(5).
- Notifications received and communicated about ACM and PACM, and their content, must be maintained by the building/facility owner and transferred to its successive owners (n)(6).
- The employer must meet the record transfer rules of 29 CFR 1910.20(h); if it stops doing business without a successor employer to keep the records as required, it must tell NIOSH at least 90 days before disposal and send the records to NIOSH if asked (n)(8).

Competent Person

- The employer must have a "competent person" able to identify asbestos and other hazards and unsanitary or dangerous conditions, and select control strategies, and with the authority to take prompt corrective measures to eliminate hazards (o)(1).
The competent person may be the employer, an employee, or a contractor of the employer.
- The competent person must inspect the job site, materials and equipment frequently and regularly (o)(2).
- The competent person must have training specific to the class of asbestos project (o)(4).

Requirements When Asbestos Levels Exceed TWA (0.1 f/cc) or EL (1.0 f/cc)

- All items required at any asbestos level.
- Regulated area (e)(1).
 - Signs at regulated areas, even if below PELs (k)(7).
- Periodic monitoring when expect to exceed a PEL, with exceptions for employees in some supplied-air or positive pressure respirators (f)(3)(ii).
- Additional engineering controls and work practices to get to or below the PELs (g)(2):
 - Local exhaust ventilation with HEPA filters.
 - Enclosure or isolation.
 - Directed make-up air with HEPA filter exhaust.
 - Other feasible engineering and work practices controls.
- Respiratory protection (h), with minimum types used (h)(2) and Table 1, and respiratory protection program (h)(3)-(4).
- Protective clothing provided when over a PEL or, when required, a negative exposure assessment (NEA) not produced (I)(1). Inspect for rips or tears (I)(4). Laundering allowed under certain conditions (I)(2).
- Additional training for all employees likely to be exposed above a PEL, before or at initial assignment and then at least annually using applicable Class I-IV curriculum, or else (k)(9)(viii) curriculum(k)(9)(I), (ii), (vii).

Class I Activities

Activities involving removal of TSI or surfacing ACM or PACM. Large Class I jobs, those involving removal of over 25 linear or 10 square feet of TSI or surfacing material, have additional requirements.

General

- All items required at any asbestos level.
- Regulated area (e), with warning signs (k)(7).
- Presumption of exposure in excess of a PEL unless an NEA is produced (f)(2)(ii).
- Daily monitoring, unless an NEA is produced, or employees use a control method in (g)(4)(I)-(iii) with supplied-air respirators operated in pressure demand mode or other positive pressure mode respirator (f)(3).
- All work supervised by competent person (g)(4)(I).
- AHERA abatement worker training (four days) (k)(8)(iii).
- Medical surveillance; see description above (m).
- The competent person must:
 - Inspect the site at least once per work shift and at any time at employee request (o)(3).
 - Do or supervise specified control duties (o)(3)(I).
 - Currently be accredited from an AHERA supervisor's course (five days), or an equivalent (o)(4)(I).

Controls

- Additional controls and work practices for large Class I jobs; for small Class I jobs, where an NEA has not been produced; or for work adjacent to a regulated area (g)(4):
 - Critical barriers or other measures to isolate area (g)(4)(ii).
 - HVAC system isolation (g)(4)(iii).
 - Impermeable dropcloths (g)(4)(iv)-(v).
 - Directed make-up air if no NEA or over PEL (g)(4)(vi).
- At least one of these control methods, as applicable (g)(5):
 - Negative pressure enclosures (g)(5)(I).
 - Glove bag. Do not move or reuse bag; use at least two persons for Class I work (g)(5)(ii).
 - Glovebags used on elbows and other connections must be specifically designed for such use (g)(5)(ii)(A)(2).
 - Negative pressure glove bag system (g)(5)(iii).
 - Negative pressure glove box system (g)(5)(iv).
 - Water spray process system (g)(5)(v).
 - Mini-enclosure (g)(5)(vi).
- Supplied Air Respirators, unless 8-hr. TWA below 1 f/cc, then tight-fitting powered air purifying respirators (PAPRs) (h)(1) and (h)(2)(v)
- Protective clothing for large jobs, or as otherwise required (I)(1).
- Hygiene facilities and practices (j).
 - Large jobs: Equipment room; shower area; clean change room; lunch areas; decontamination of workers, equipment and containers (j)(1).
 - Small jobs: Equipment room, decontamination of workers, equipment, and containers (j)(2).
- Alternative controls may be used (g)(6). To do so, a Certified Industrial Hygienist or licensed Professional Engineer who is an AHERA project designer must evaluate the planned work based on data for worst-case conditions and equivalent employee training and experience, and certify the planned controls as adequate (g)(6)(ii); a competent person may evaluate and certify small jobs (g)(6)(ii)(A). OSHA must be notified in advance for large jobs (g)(6)(iii).

Class II Activities

Activities involving removal of ACM which is not TSI or surfacing material. This includes, but is not limited to, the removal of asbestos containing wallboard, floor tile and sheeting, roofing, and siding shingles and construction mastics.

General

- All items required at any asbestos level.
- Regulated area (e), with warning signs (k)(7).
- Daily monitoring, unless an NEA is produced, or employees use supplied-air respirators operated in pressure demand mode or other positive pressure mode respirator (f)(3).
- All work supervised by competent person (g)(7)(I).
- AHERA abatement worker training,

unless working with only one generic category of building material, then job-specific training (8 hours for roofing, flooring, siding, ceiling tile, or transite panel work) based on (k)(9)(viii) curriculum and specific relevant work practices and engineering controls (g), with hands-on training (k)(9)(iv). (See below for training on roofing and resilient flooring removal.)

- Medical surveillance; see description above (m).
- The competent person must:
 - Inspect sufficiently to assess whether conditions have changed, and at reasonable time upon employee request (o)(3).
 - Do or supervise specified control duties (g)(7)(I), (o)(3)(I).
 - Currently be accredited from an AHERA supervisor's course (five days), or an equivalent (o)(4)(I).
- Special rules for resilient flooring removals and roofing work (see below).

Controls

- Critical barriers, or other isolation method required if: (1) no NEA; (2) TWA/EL exceeded; or (3) material is not removed intact (g)(7)(ii).
 - Impermeable drop cloths beneath all removal activity, except removal of flooring or roofing material from a solid substrate underneath the material (g)(7)(iii).
 - Equipment room or area covered by impermeable drop cloth for entry and decontamination when exceed a PEL or no NEA produced (j)(2).
 - Work practices set forth in (g)(1).
 - Respiratory protection where ACM not removed in substantially intact state, wet methods not used (except for intact removal of sloped roofing ACM with an NEA, or certain non-wet removal of intact resilient flooring material using heat, see below), no NEA produced, a PEL exceeded, or in an emergency (h)(1). An employer must inform employees that a tight-fitting PAPR must be provided in lieu of a negative pressure respirator, at the employee's request (h)(2)(iii)(B).
- Hygiene facilities and practices where a PEL is exceeded or no NEA produced: equipment room, decontamination of workers, equipment, and containers (j)(2).
 - Additional controls and practices, as applicable (g)(8):
 - Glove bag or glove box, only if fully enclose the material to be removed (g)(8).
 - Vinyl and asphalt flooring material (g)(8)(I).
 - Roofing material (g)(8)(ii).
 - Cementitious siding or shingle, or Transite panel (g)(8)(iii).
 - Gasket (g)(8)(iv).
 - For other Class II materials: use wet methods; remove intact if feasible; no cutting, abrading or breaking (unless nothing better); wrap or bag debris (g)(8)(v).
 - Alternative controls may be used (g)(8)(vi). To do so, a competent person must evaluate the planned work under all expected conditions, based on data for closely similar conditions and equivalent employee training and experience, and certify the planned control method as adequate (g)(8)(vi)(A), (B).
 - Rules Unique to Intact Removal of Resilient Flooring
 - NEA may be based on data in OSHA rulemaking record when all three criteria are met: (1) only those work practices for flooring removal referred to as "compliant work

- practices" in OSHA Compliance Directive C.P.L. 2-2.63, at D-34 to D-36 (Nov 3, 1995) ("OSHA Compliance Directive"), as implemented in WP R-1A and R-2A of this Manual, are used; (2) all workers have completed the required 8-hour intact resilient floor covering removal training course (Compliance Directive at D-50 to D-52); and (3) prior to the removal, a competent person assesses the job and determines that the flooring is intact and likely to remain intact throughout the removal process.
- "Intact" means that flooring material has not crumbled, been pulverized, or otherwise deteriorated so that it is no longer likely to be bound with its matrix. Incidental breakage or slicing of flooring material when using work practices specified above does not mean that the material is non-intact.
 - Competent persons supervising intact flooring removal operations only must have the 8-hour worker training course, plus four hours of supervisory training (Compliance Directive at D-53 to D-54).
 - Respirators not required if material removed intact, even if heat is used along with other compliant work practices and wet methods are not. (Note: respirators may be needed for reasons other than asbestos. For example, if tiles are overheated, harmful fumes might be released and a respirator with organic vapor cartridges might be needed.)
 - Caution: If the material is not removed intact, additional protections, such as critical barriers, respirators, and additional training for employees and competent persons is required before work can continue (See OSHA Compliance Directive at D-40 Paragraph 3 and D-44 Paragraph 10). Mechanical chipping is prohibited unless performed in a negative exposure enclosure (g)(8)(I)(F).
- For employers who remove 'intact' flooring materials using compliant work practices, the requirement to notify employers of employees who work on adjacent areas (k)(3)(ii)(B) applies only to employers of employees who, during removal of flooring material, work in areas not separated from the work area by an impermeable barrier, which may include a wall, closed door or window.
- Rules Unique to Removal/Repair of Asbestos-Containing Roofing:
 - Remove intact to extent feasible. Isolate roof level heating and ventilation air intake sources or shut down ventilation system (g)(8)(ii)(A),(G).
 - Wet methods: Remove roofing wet if it is or will become non-intact, unless wet methods infeasible or will create safety hazards (g)(8)(ii)(B). Wear respirators if wet methods not used, except for intact removal of sloped roof ACM with an NEA (h)(1)(iii). Continuously mist cutting machines, unless it substantially decreases worker safety (g)(8)(ii)(C). (See below for small scale work.)
 - To remove built-up roofs with asbestos-containing roofing felts using a power roof cutter: For aggregate or smooth surface, collect resulting dust by a HEPA dust collector or HEPA vacuuming; for smooth surface, resulting dust may also be collected by gently sweeping and then carefully and completely wipe up all the still-wet dust and debris, Immediately bag dust and debris or place in covered containers (g)(8)(ii)(D). (See below for small scale work.)

- Wastes: Carry or pass roofing to the ground by hand, or lower it via covered, dust-tight chute, crane or hoist; do not drop or throw it to the ground. Lower ACM to the ground as soon as practicable during the work shift. While non-intact removed ACM is on the roof, keep it wet, in an impermeable waste bag, or wrapped in plastic sheeting. Transfer unwrapped ACM to a closed receptacle upon its being lowered to the ground, precluding dust dispersion (g)(8)(ii)(E),(F).
 - Small scale work exception: Wet methods or HEPA vacuuming not required when remove or repair under 25 square feet of an intact roof on one day by manual methods which do not render the material non-intact or create visible dust (g)(8)(H).
- Alternative methods for intact installation, removal (Class II), and repair and maintenance (Class III) (g)(11):*
- Employer may use these methods; if
 - employer does not, or material does not remain intact, general control provisions (g)(8) apply (g)(11).
 - Competent person inspects worksite before work and as needed during job to determine if roofing is intact and will likely remain so (g)(11)(I).
 - Train employees using (k)(9)(viii) curriculum (g)(11)(ii).
 - Use manual methods which do not render roofing non-intact. Do not sand, abrade, or grind roofing (g)(11)(iii).
 - Carry or pass roofing to the ground by hand, or lower it via covered, dust-tight chute, crane or hoist; do not drop or throw it to the ground. Lower ACM to the ground as soon as practicable during the work shift (g)(11)(iv).
 - Employer notifies building owner of presence and location of AC roofing products installed on non-residential roofs by end of job (g)(11)(v).

Class III Activities

Repair and maintenance operation where ACM, including TSI and surfacing ACM and PACM, is likely to be disturbed, limited in size to amounts that can be contained in a standard size glove or waste bag.

General

- All items required at any asbestos level.
- Regulated area (e), with signs (k)(7).
- Periodic monitoring when expect to exceed a PEL (f)(3)(ii).
- AHERA operations and maintenance course or equivalent (16 hours), unless it does not cover the training needed for the specific work, in which case, train on (k)(9)(viii) curriculum and specific relevant work practices and engineering controls (g), with hands on training (k)(9)(v).
- Medical surveillance; see description above (m).
- Glove bag, mini-enclosure or other isolation method required if TSI or surfacing is cut, drilled, sawed, sanded abraded, chipped, or broken (g)(9)(iii).
- The competent person must:
 - Inspect sufficiently to assess

whether conditions have changed, and at any reasonable time upon employee request (o)(3).

- Currently be accredited in an AHERA operations and maintenance course (16 hours), or an equivalent; or the supervisor course (o)(4)(ii).
- See discussion of roofing repair and maintenance in Class II text, above.

Controls

- Control include wet methods; local exhaust ventilation where feasible; impermeable drop cloths, and mini-enclosures or glove bags when drilling, cutting, abrading, sanding, chipping, breaking.
- Impermeable drop cloths and mini-enclosure, glove bag, or other isolation method, when drilling, cutting, abrading, sanding, chipping, breaking

or sawing TSI or surfacing (g)(9)(iii).

- On all other Class III operations, use impermeable dropcloths and plastic barriers, or glove bag, etc., if no NEA or if PEL is exceeded.
- Respiratory protection where wet methods are not used, except for intact removal of sloped roofing ACM with an NEA; NEA not produced; TSI or surfacing ACM or PACM being disturbed; a PEL exceeded; or in an emergency (h). An employer must provide an employee with a tight-fitting PAPR, in lieu of a negative pressure respirator, at the employee's request.
- Hygiene facilities and practices, where exposures exceed a PEL, or no NEA produced: Equipment room; decontamination of workers, equipment, and containers (j)(2).

Class IV Activities

Maintenance and custodial activities during which employees contact but do not disturb ACM or PACM, and activities to clean up waste and debris resulting from Class I, II, and III activities.

General

- All items required at any asbestos level.
- Periodic monitoring when expect to exceed a PEL (f)(3)(ii).
- EPA awareness training course for maintenance and custodial workers or equivalent (2 hours) (k)(9)(vi). EPA does not consider 2-hour awareness training adequate for Class IV workers cleaning up dust, waste and debris from Class I, II and III work. These workers should receive the training appropriate for the Class of work involved. **Caution to employers:** do not allow workers with only two hrs

training to disturb asbestos.

- Assume waste and debris in areas with accessible friable TSI or surfacing materials contain asbestos (g)(10)(ii); assume dust in close proximity to deteriorated ACM also is ACM (C.P.L. 2-2.63 at C-18).
- The competent person must:
 - Inspect sufficiently to assess whether conditions have changed, and at any reasonable time upon employee request (o)(3).
 - Currently be accredited in an AHERA operations and maintenance course (16 hours), or

an equivalent; or the supervisor course (o)(4)(ii).

exceeded; or in an emergency (g)(10)(I), (h)(1).

Controls

- Controls include wet methods, HEPA vacuums, prompt clean up of debris containing ACM or PACM (g)(10).
- Respiratory protection where Class IV work done in regulated areas where other work requires respirators; a PEL

• Hygiene facilities and practices:

- When in regulated area, same as for other work (j)(3).
- When cleaning up TSI or surfacing ACM or PACM debris and material, provide (j)(2) decontamination facilities (j)(3).

Minimum Training Requirements

29 CFR 1926.1101

Training is the employer's responsibility, and must be provided (k)(9)(I)-(ii):

- at the employer's expense;

- prior to initial assignment; and
- at least annually thereafter.

Workers

Class I:

32 hr. EPA/AHERA (k)(9)(iii)

Class II:

- all asbestos-containing materials, except surfacing and TSI
 - if work requires critical barriers, equivalent isolation or a negative pressure enclosure, then 32 hr. EPA/AHERA abatement worker training is required.
- roofing, flooring, siding ceiling tiles, transite panels: 8 hr. minimum training time for each category of material, covering (k)(9)(iv):
 - all (k)(9)(viii) elements;
 - all applicable paragraph (g) elements
 - The minimum curriculum for intact resilient flooring removal training course is set forth in OSHA Compliance directive at D-50 to D-52.
 - "hands-on" training
- other miscellaneous materials: at least four hours for each category of material, but covering:
 - all (k)(9)(viii) elements;
 - all applicable paragraph (g) elements
 - "hands-on" training
 - If Class II materials are friable or become friable during removal, EPA requires the full 32 hour worker training course.

Class III:

16 hr. EPA/AHERA O&M course (k)(9)(v)

Exception: where competent person deems such training inadequate, and then training must include for each category of material worked with:

- all (k)(9)(viii) elements;
- all applicable paragraph (g) elements
- "hands-on" training

Class IV:

2 hr. EPA/AHERA Awareness Training Course or equivalent (k)(9)(vi)

Other Workers:

- exposed at any level, even below PEL:
 - General Safety training (29 CFR 1926.21) and hazard communication (hazcom) training (29 CFR 1926.59)
- Employees likely to be exposed above PEL (k)(9)(vii):
 - training to include all (k)(9)(viii) elements.
- EPA does not consider 2 hours of awareness training as adequate for workers cleaning up dust, waste and debris from Class I, II or III work. Workers involved in these activities should have the training appropriate to the class of work involved.

Competent Persons

Class I and II:

40 hr. EPA/AHERA supervisor training course (o)(4)(I)

Exception:

Class II intact¹, resilient flooring removal operations: 4 hr. supervisor course supplemental to basic 8 hr. worker training course

Class III and IV:

16 hr. EPA/AHERA O&M Worker Training Course or 40 hr. EPA/AHERA supervisor training course. (o)(4)(ii). The competent person for Class IV work involving clean-up of dust, waste and debris from Class I, II or III activities should have 40 hr. EPA/AHERA supervisor training course.

-
1. These operations are described as non-aggressive in the NIBS Model Guide Specifications.

OSHA : ASBESTOS IN GENERAL INDUSTRY STANDARD

(1910.1001):

Scope of coverage

The industry standard covers employee exposure to asbestos in a wide variety of industrial and commercial settings where the employee is not engaged in construction activity. For example, this standard covers:

- General housekeeping involving

asbestos containing material in industrial and commercial facilities unless such housekeeping occurs during or after construction activities.

- Repair and replacement of automotive brakes and clutches.

General

- Exposure, Assessments and Monitoring

- Initial monitoring of employees who are, or may reasonably be expected to be, exposed to the time-weighted average (TWA) of 0.1 f/cc or the excursion limit (EL) of 1 f/cc (30 minute average) unless data generated after March 31, 1992 or objective data show that the TWA and EL will not be exceeded.
- Periodic monitoring required unless initial monitoring, if required, or periodic monitoring statistically indicates that the employee exposures are below the TWA or EL.
- Additional monitoring needed when work changes or the other reason may cause new or additional exposures above the TWA or EL.
- Employer must notify employee of monitoring results.

- General controls

- Use wet methods insofar as practicable.
- Compressed air to remove asbestos

is prohibited (unless in enclosed ventilation systems).

- Employee rotation to reduce exposure is prohibited.
- When vacuuming asbestos containing waste and debris, HEPA vacuums are required and must be used so as to minimize asbestos dispersal.
- Dry sweeping and shoveling only where vacuuming and/or wet cleaning are not feasible.
- Asbestos waste must be sealed in impermeable labeled bags or containers so as to minimize asbestos dispersal.
- Controls for Care of Asbestos Containing Flooring
 - Sanding is prohibited.
 - Stripping of finishes must use low abrasion pads at speeds lower than 300 rpm and wet methods.
 - Burnishing or dry buffing may be used only on floors with sufficient finish so that pad does not contact ACM.

Identification of Materials and Communication

- Building/facility owner (which includes a lessee) must inform employers of employees, and employers must inform employees, who perform housekeeping activities in areas which contain ACM and/or presumed asbestos-containing material (PACM) of the presence and location of ACM and PACM in such areas.
 - Presume or inspect surfacing, thermal system insulation (TSI), or resilient flooring material in housekeeping area:
 - TSI and sprayed-on or troweled-on surfacing materials in buildings or substrates constructed before 1980 are PACM; resilient flooring material installed before 1980 is also presumed to be ACM, although the term "PACM" is not used for it.
- Can rebut presumptions:
- For PACM, an AHERA inspection, or testing of the material being worked on by an AHERA-accredited inspector or a Certified Industrial Hygienist, is required; a nationally recognized testing program (National Voluntary Laboratory Accreditation Program (NVLAP) or equivalent) must be used for analysis.
 - For resilient flooring material, an industrial hygienist must use recognized analytical techniques.

Warning Labels

Labels must be placed on products containing asbestos, including waste containers and, where feasible, installed products, unless asbestos fibers are bound

so that no reasonably foreseeable work will release them above TWA or EL, or when less than 1%.

Training

- Employer at no cost to employee who performs housekeeping operations in areas which contain ACM or PACM must provide an asbestos awareness training course (2 hours) which covers (1) health effects of asbestos exposure; (2) location of ACM and PACM; (3) recognition of ACM and PACM damage; (4) housekeeping requirements; and (5) proper response to fiber release episodes.
 - For employees exposed to asbestos at or above the TWA or excursion limit, the employer must provide more extensive training which covers (1) health effects of asbestos exposure; (2) smoking risks; (3) nature of asbestos operations that could result in asbestos exposure; (4) engineering controls and work practices; (5) respirators and protective clothing; (6) medical surveillance and (7) warning signs and labels.
- Record Retention
 - Exposure monitoring records: 30 years. Records based on objective data: while employer relies on data.
 - Medical surveillance records: Employment plus 30 years.
 - Training records: Employment plus one year.
 - Data to rebut PACM: While employer relies on data.

Requirements when Asbestos Levels Exceed TWA or Excursion Limit

- All items required above.
- Regulated areas, which includes demarcating the area from the rest of the workplace, limiting access to authorized personnel, and posting warning signs.
- Feasible engineering controls and work practices to reduce exposures to PEL and excursion limit and below.
- Respiratory protection which meets selection requirements and respiratory protection program.
- Protective clothing, including inspection for rips or tears.
 - Laundering allowed under certain conditions.
- Hygiene facilities which include a change room, showers, and lunchroom facility.
- Medical surveillance which includes an annual medical examination whenever an employee is exposed at or above the PELs.
- Additional training.

OSHA

Hazard Communication Standard

(1926.59)

- The purpose is to ensure that the hazards of all chemicals produced or imported are evaluated, and information concerning their hazards is transmitted to employers and employees.
- The standard applies to any chemical which is known to be present in the workplace in such a manner that employees may be exposed under normal conditions of use or in a foreseeable emergency.
- Chemicals must be evaluated to determine if they are hazardous.
 - Chemical manufacturers and importers are required to perform evaluations on chemicals they produce or import.
 - Employers can rely on evaluations performed by manufacturers and/or importers, or they can choose to perform their own evaluation.
- Employers are required to develop, implement and maintain a written hazard communication program at the worksite. The written program must contain information addressing the following issues:
 - Labeling containers and other forms of warning.
 - Material safety data sheets.
 - Employee information and training.
 - A list of the hazardous chemicals known to be present at the worksite.
 - The methods the employer will use to inform employees of the hazards of non-routine tasks.

OSHA

Head Protection

(1926.100)

- Employees working in areas where there is a possible danger of head injury from falling or flying objects, or from electrical shock and burns, must be protected by protective helmets.
- Protective helmets must meet the specifications contained in ANSI Z89.1 (impact and penetration), or ANSI Z89.2 (electrical shock and burns).

OSHA

Hearing Protection

(1926.101)

Whenever it is not feasible to reduce noise levels below the levels specified in 29 CFR 1926.52, employees must be provided with, and use, adequate hearing protection.

OSHA

Eye and Face Protection

(1926.102)

- If the potential for eye or face injury exists, employees must be provided with eye and face protection. The potential for injury may come from physical, chemical or radiation agents.
- The eye and face protection must meet the requirements specified in ANSI Z87.1.

OSHA

Respiratory Protection

(1926.103)

The standard contains some general requirements for respiratory protection. 29 CFR 1926.1101 contains some specific requirements for respirator use during construction activities involving asbestos. The requirements of 1926.1101 should be

followed, with 1926.103 (or other specific standards, such as 1926.62, for lead) being referenced for issues not covered by 1926.1101.

OSHA

Safety Belts, Lifelines, and Lanyards

(1926.104)

- Safety belts, lifelines and lanyards can only be used for employee safeguarding. A device must be immediately removed from service after being subjected to a service load.
- Specifications for safety belts, lifelines and lanyards are given in the standard.

OSHA

Fire Protection and Prevention

(1926.150)

Fire protection and prevention standards are contained in Subpart F of 29 CFR 1926.

Fire Protection (1926.150)

- The employer must develop a fire protection program, which must be followed throughout all phases of the project. The program should ensure:
 - There is no delay in providing the necessary firefighting equipment.
 - Access to the equipment is maintained at all times.
 - Firefighting equipment will be conspicuously located.
 - Firefighting equipment will be periodically inspected and maintained in operating condition.
 - If warranted by the project, a trained and equipped fire brigade will be provided by the employer.
 - A temporary or permanent water supply, sufficient for the firefighting equipment will be provided.
- Portable firefighting equipment will be provided as follows:
 - Portable fire extinguishers, or acceptable substitutes must be provided for each worksite as specified in the standard.
 - Portable fire extinguishers shall be inspected periodically and maintained in accordance with NFPA No. 10A-1970.
 - Acceptable fire hoses with appropriate connections may be substituted for fire extinguishers as specified in the standard.
- Fixed firefighting equipment shall be maintained operational as long as possible during demolition projects.
- Employers shall establish fire alarm systems to alert employees and the fire department during construction projects.
- Fire walls and exit stairways will be given priority during construction, and fire cutoffs will be retained as long as possible during alterations or renovation.

OSHA

Disposal of Waste Material (1926.252)

- Whenever materials are dropped more than 20 feet to any point lying outside the exterior walls of the building, an enclosed chute shall be used.
- When debris is dropped through holes in the floor without the use of chutes, the area onto which the material is dropped shall be completely enclosed with barricades constructed in accordance with the standard.

OSHA

Lockout and Tagging of Circuits (1926.417)

- The employer must maintain a written copy of the lockout/tagout procedures, and make the copy available to employees.
- Electric circuits and equipment must be de-energized prior to employees working on them.
 - Only qualified employees, as defined by the standard, can perform de-energization procedures.
 - Safe procedures for the de-energization must be determined prior to de-energizing circuits or equipment.
 - Stored electric energy which might endanger personnel must be released.
 - Capacitors must be discharged and high capacitance elements must be short-circuited and grounded if the stored electric energy might endanger personnel.
 - A qualified person must use test equipment to check that the circuit elements and electrical parts which employees will be exposed to are actually de-energized. The qualified person must also verify that the equipment cannot be restarted after de-energization.
- Locks and/or tags must be placed on each disconnecting means used to de-energize circuits and equipment as specified in the standard.
 - Locks must be applied in a way that will prevent any person from operating the disconnecting means without using undue force.
 - Each tag should contain a statement prohibiting unauthorized operation of the disconnect and removal of the tag.
 - If a tag is used without a lock, when permitted in the standard, at least one additional safety measure must be used which provides a level of security equivalent to the use of a lock.
- Re-energization steps outlined in the standard must be followed in order.
 - A qualified person must conduct tests and visual inspections, as necessary, to verify that all tools, electrical jumpers, shorts, grounds, and other such devices have been removed prior to re-energizing circuits or equipment.
 - All employees exposed to the hazards associated with re-energizing the equipment must be

warned to stand clear.

- Each lock and/or tag must be removed by the person who applied it, or under his/her direct supervision, except as allowed by the standard.
- A visual determination must be made that all employees are clear of the hazards associated with re-

energizing equipment and circuits.

- When employees are exposed to parts of fixed electric equipment or circuits which have been de-energized, the circuits must be locked out, tagged out, or both in accordance with the standard.

OSHA

Scaffolding

(1926.451)

- Scaffolds must be erected in accordance with the standard.
- The footing or anchorage for scaffolds must be sound, rigid and capable of carrying the maximum intended load without settling or displacement. Unstable objects cannot be used to support scaffolds.
- A competent person, as defined by the standard, must supervise the erection, movement, alteration, and dismantling of scaffolds.
- Guardrails and toeboards must be installed on all open sides and ends of platforms more than ten feet above the ground or floor, with the exception of needle beam scaffolds and floats. Scaffolds 4 feet to 10 feet in height, having a minimum horizontal dimension in either direction of less than 45 inches, must have standard guardrails installed on all open sides and ends. Guardrails, midrails, and toeboards must meet the requirements set forth in the standard.
- Scaffolds and their components must be capable of supporting 4 times the maximum intended load. Any scaffold component, including accessories must be immediately repaired or replaced when damaged or weakened by any cause.
- Lumber used in the construction of scaffolding must meet the specifications in the standard.
- An access ladder or other equivalent safe access must be provided.
- The height of free-standing mobile scaffold towers cannot exceed four times the minimum base dimension.
- The force necessary to move a mobile scaffold must be applied as near to the base as practicable, and the tower must be stabilized during movement from one location to another.
- Scaffolds can only be moved on level floors, free of obstructions and openings.
- Employees must not ride on manually propelled scaffolds unless the conditions listed in 1926.451 are met.

OSHA

Grounding for Protection of Employees

(1926.954)

- All conductors and equipment must be treated as energized until tested or otherwise determined to be de-energized, or until grounded.
- Grounds should be placed between the work location and all sources of energy and as close as practicable to the work location. The ground end should be attached first, and the other end attached and removed using insulating tools or other suitable devices.

EPA

Asbestos Hazard Emergency Response Act (AHERA)

- Signed into law on October 22, 1986.
- Required EPA to develop regulations which provide a comprehensive framework for addressing asbestos problems in public and private elementary and secondary schools. The regulations had to address:
 - The inspection of all public and private school buildings for ACM.
 - The identification of circumstances requiring response actions involving friable ACM.
 - Friable ACM means ACM, when dry, which may be crumbled, pulverized or reduced to powder by hand pressure and includes previously non-friable material which becomes damaged to the extent that when dry it may be crumbled, pulverized, or reduced to powder by hand.
 - A description of the appropriate response actions involving friable ACM.
 - The implementation of response actions involving friable ACM, including non-friable ACM that becomes friable when being worked on.
 - The establishment of a reinspection and periodic surveillance program for ACM.
 - The establishment of an operations and maintenance program for friable ACM.
 - The preparation and implementation of asbestos management plans by local educational agencies (LEAs) and the submission of the management plans to State Governors.
 - The transportation and disposal of friable waste ACM from schools.
 - A model accreditation plan for persons who inspect for asbestos, develop management plans, and design or conduct response actions.
 - An accreditation program for laboratories which analyze asbestos bulk and air samples.

Summary of AHERA regulations

Regulations were issued as Asbestos-Containing Materials in Schools; Final Rule and Notice (40 CFR Part 763)

- Requires local education agencies (LEAs) to identify friable and nonfriable ACM in public and private elementary and secondary school buildings. Inspections of schools in existence at the time the standard was issued must have been completed by October 12, 1988. Buildings acquired after October 12, 1989, which will be used as schools, must be inspected prior to use as a school building (for emergency use they must be inspected within 30 days).
- Inspections and reinspections must follow the protocol specified in the standard (763.85), as must sampling (763.86), analysis (763.87) and assessment (763.88).
- Every time an assessment or

reassessment is performed the accredited inspector must provide a written assessment of all friable known or assumed asbestos-containing building material (ACBM) in the school building.

- LEAs must have submitted management plans to the Governor of their State by October 12, 1988, begun implementation of the management plans by July 9, 1989, and completed implementation in a timely fashion.
- LEAs must use accredited persons to conduct inspections, reinspections, and assessments, develop management plans, or perform response actions involving friable ACM, including non-friable ACM that becomes friable when being worked on.
- LEAs must provide for the transportation and disposal of friable asbestos in accordance with EPA guidance documents.
- LEAs must ensure that all maintenance and custodial employees are properly trained according to Federal and/or State regulations.
- LEAs must ensure that workers and building occupants, or their legal guardians, are informed at least once each school year about asbestos inspections, reinspections, response actions involving friable ACM, and post-response action activities, including periodic reinspection and surveillance activities that are planned or in progress.
- LEAs must provide short term workers who may come in contact with ACBM with information about the location of ACM and material assumed to be ACBM.
- Warning labels, meeting the requirements of the standard, must be posted.
- Management plans must be available for inspection.
- A person must be designated to ensure that the requirements of the standard are met. The designated person must receive adequate training to perform all the duties required by the standard.
- Reinspections of schools must be performed at least once every three years after a management plan is in effect. The reinspection must follow the protocol set forth in the standard.
- The LEA must select and implement appropriate response actions involving friable ACM consistent with inspections and assessments which have been conducted by accredited inspectors. Accepted response actions involving friable ACM are outlined in 763.90.
- LEAs must implement asbestos operations and maintenance (O&M) programs whenever any friable ACBM is present or assumed to be present in a building it leases, owns or otherwise uses as a school building. O&M activities must follow the specifications of 763.91. Training of individuals involved with O&M activities must follow 763.92.
- At least once every 6 months after a management plan is in effect, a periodic surveillance of school buildings containing known or assumed ACBM must be performed.
- Management plans must be developed according the requirements of 763.93.
- Records associated with ACM in schools must be maintained in accordance with 763.94.

EPA Asbestos School Hazard Abatement Reauthorization Act (ASHARA)

- Enacted on November 28, 1990.
- Applies to public and commercial buildings.
- Did not require public and commercial buildings to perform inspections for ACM.
- Expanded the accreditation requirements of AHERA to apply to certain persons who work with asbestos in public and commercial buildings. Specifically, accreditation is required for any person engaged in:
 - Inspecting for ACM.
 - Designing ACM response actions involving friable ACM, including non-friable ACM that becomes friable when being worked on.
 - Conducting response actions involving friable ACM. The number of training hours for asbestos abatement worker training was increased from 32 to 40.
 - Provided for a civil penalty for contractors who failed to comply with TSCA accreditation.

EPA Asbestos NESHAP (40 CFR 61.140-157)

Section 112 of the Clean Air Act (42 U.S.C. 7401 and following sections), enacted in 1970, requires the EPA to address hazardous air pollutants. The following year, EPA designated asbestos as a hazardous air pollutant under the Act, and later issued its National Emission Standard for Asbestos (40 CFR 61.140-157) as one of the National Emission Standards for Hazardous Air Pollutants (NESHAP).

In general, the asbestos NESHAP requires that the owner or operator of a facility or of a renovation or demolition activity at the facility:

- Inspect at least the area of the facility to be renovated or demolished for the presence of asbestos.
- Remove, transport and dispose of Regulated Asbestos-containing Material (RACM), as defined below, without releasing visible emissions, usually by using wet removal methods.
- Notify the EPA (or a State- or local-delegated agency) in advance of the removal, above specified project amounts or annual amounts, of these regulated ACM. Note: All demolition projects require notification, regardless of presence, or absence, of asbestos.
- Dispose of regulated asbestos-containing waste or convert it to non-asbestos material at an EPA-approved facility, and have a waste shipment record, signed by the waste generator, transporter(s) and disposal facility, returned promptly to the owner or operator.

NESHAP Coverage

The asbestos NESHAP covers most asbestos removed from buildings other than single-family houses or apartments of 4 or fewer units, which are not addressed by the standard. Before any renovation or demolition project, the affected area must be thoroughly inspected for the presence of asbestos. (The OSHA asbestos in construction standard describes requirements for this inspection for most buildings; the EPA AHERA standard does so for K-12 schools. See the discussion of these standards in this NIBS regulatory appendix.)

The standard requires agency notification (par.145(b)), control of asbestos emissions (par.145(c)), and control of asbestos waste disposal (par.150), for removing regulated ACM (defined below) of at least the following threshold amounts (par.145(a)):

- 260 linear feet (80 meters) on pipes,
- 160 square feet (15 square meters) on other facility components, or
- 35 cubic feet (1 cubic meter) off facility components where the length or area could not be measured previously,
- All demolition projects, even if no asbestos is present.

These amounts apply to a single renovation or demolition project. They also apply to work over a calendar year, such as from a series of renovations, demolitions, or an operations and maintenance program.

For demolitions involving smaller amounts of regulated ACM, or a facility

being demolished under a State or local government order because it is structurally unsound and in danger of imminent collapse, certain notification and controls are retained, but some are eliminated. (See below for descriptions.)

For the NESHAP, regulated ACM (RACM) is essentially ACM that may release fibers during or after the removal work. More formally, it is defined (par.141) as:

- Friable ACM, that is, ACM which, when dry, can be crumbled, pulverized, or reduced to powder by hand pressure.
- Category I nonfriable ACM (packing, gasket, resilient floor covering, or asphalt roofing product ACM) that has become friable, or will be or has been sanded, ground, abraded, or cut (but not sheared, sliced or punched).
- Category II nonfriable ACM (other nonfriable ACM) that has a high probability of becoming or has been crumbled, pulverized, or reduced to powder by the forces expected to act on the material.

Based on this definition, Category I nonfriable ACM that has not and will not become friable, sanded, ground, abraded, cut, sawed, sheared, sliced, or punched and Category II nonfriable ACM that has not and will not become crumbled, pulverized, or reduced to powder, are not RACM, and need not be removed prior to demolition. Mere breakage does not cause nonfriable ACM to become RACM.

Notification

For renovations involving the removal of RACM above the threshold amounts, and for all demolitions, the owner or operator must notify the EPA (or a State- or local-delegated agency) fully in advance on a project-by-project basis or annually (par.145(a)). Each individual project is

covered, even if some or all of them are below the threshold amounts, when the threshold amounts are met or exceeded over a calendar year by all of the activities at a facility together (par.145(a)(4)(iii)). Note: Individual O&M activities which remove an amount of RACM above the

notification threshold must be separately notified as specific planned projects.

Content:

These notifications for work at or above the threshold amounts must include the following items (par.145(c)(4)), using a form similar to the form in the standard (par.145(b)(5)). (Note that States or localities may have additional notification requirements).

- Whether it is an original notice, or revises or cancels a previous notice.
- Contacts: Names, addresses and phone numbers of owner, removal contractor, and other contractor(s).
- Facility description: Address, work location, size of affected area, age, present and prior use.
- Operation description:
 - Whether work is renovation or demolition (taking out any load-supporting structural member and related handling, or intentional burning).
 - Inspection, sampling and analytical methods to detect RACM and nonfriable ACM. Note that these inspections generally must be performed by an EPA-MAP accredited person and many states require them to be licensed, as well. However, EPA does not require MAP accreditation for inspections of resilient flooring prior to removal or repair of flooring that has not been sanded, ground, mechanically chipped, drilled, abraded, or cut (sawed, but not sheared, sliced or punched).
 - Estimated amount of RACM to be removed.
 - Estimated amount of nonfriable ACM that will not be removed before any demolition.
 - Scheduled starting and completion dates of asbestos-related work, and of all of the demolition or renovation work.
- Renovation, demolition, and asbestos emission control methods, and affected components.
- Name and location of EPA-approved asbestos waste disposal site.
- Certification that at least one "on-site representative" of management trained in the NESHAP will be present during the asbestos demolition or renovation work (par.145(c)(8)). An OSHA 'competent person' may satisfy this requirement if trained in NESHAP requirements.
- Procedures to be followed if unexpected RACM is found or Category II nonfriable ACM becomes friable.

Schedule:

These notifications for work at or above the threshold amounts must be delivered to the agency:

- By regular mail, commercial delivery or hand delivery, but not facsimile or e-mail (par.145(b)(1)).
- For a single project, at least 10 working days before the start of work which may disturb asbestos (par.145(b)(3)(I)).
- For a calendar year's worth of projects, at least 10 working days before the start of the calendar year. (Delivery by December 11 satisfies this requirement in every year.) For annual notification, the period of work in the notice is the whole year.
- For a delayed start, by telephone and written notice as soon as possible before the original starting date. For an advanced start, by written notice at least 10 working days before the asbestos work or demolition.
- When items in the notification change, including when the amount of asbestos affected changes by 20% or more or changes in start or completion dates.

Special cases:

For demolitions involving amounts of RACM smaller than the threshold (par.145(a)(2)): (However, note that all friable asbestos, in any amount, must be removed prior to demolition.)

- Notice must be delivered at least 10 working days before demolition starts.
- The form in the standard need not be used.
- Certain notification elements need not be provided:
 - Scheduled starting or completion dates of asbestos-related work, although the dates for the whole demolition or renovation work must still be given.
 - Renovation, demolition, or asbestos emission control methods, or affected components.
 - Waste disposal site name or location; or the transporter(s) contact information.
 - Having an "on-site representative," although a "competent person" under the OSHA construction standard, with generally similar training, must still supervise the work.

For demolition under a State or local government order because a facility is structurally unsound and in danger of imminent collapse:

- Deliver a copy of the order, and certain related information (par.145(b)(xv)).
- Some notification elements are reduced (par.145(a)(3)):
 - The notice must be delivered as early as possible before the asbestos work, but never later than the working day following its start.
 - Scheduled starting and completion dates of asbestos-related work need not be provided, but the dates of the whole demolition or renovation work must be submitted.

For emergency renovations resulting from sudden, unexpected events (par.145(a)(4)(iv)):

- The notice must be delivered as early as possible before the asbestos work, but never later than the working day following its start (par.145(b)(3)(iii)).
- No revised notice need be submitted if the starting date changes (par.145(b)(3)(iv)).

Controls

In general:

- Adequately wet all RACM (par. 145(c)(6)). (Note: user should become familiar with EPA Booklet, "Asbestos/NESHAP Adequately Wet Guidance" (Dec., 1990).) Certain exceptions are described below for using HEPA filtered control of stripping or leak-tight wrapping. Another exception is if the temperature at the point that would be wet is below 32°F (0°C), in which case (par. 145(c)(7)): (Note that EPA must give written permission for dry removal, except for freezing weather conditions.)
 - Remove facility components with RACM in units or sections to the maximum extent possible.
 - Record temperatures at the start, middle and end of the workday, and keep records on site at least 2 years.
- Carefully lower RACM to the ground or floor (do not drop, throw, slide or otherwise damage or disturb it) (par. 145(c)(6)); if RACM is removed over 50 feet (15 meters) above ground level, transport it in leak-tight chutes or containers (par. 145(c)(6)(iii)).
- Have at least one on-site representative of management trained in the NESHAP and the means of

complying with it, present during stripping, removal or handling or disturbance of RACM (par. 145(c)(8)).

- The training of the on-site representative shall follow the curriculum in par. 145(c)(8), with documentation posted, and refreshed at least every 2 years.
- The EPA accepts persons who are accredited as asbestos contractor/supervisors under AHERA as being trained as on-site representatives under the NESHAP. A "competent person" or "qualified person" under the OSHA asbestos in construction or shipyard standards, respectively, may also be an on-site representative if that person's training covers the NESHAP as well as OSHA requirements.

Before demolishing a building by burning, remove all ACM, including friable ACM, Category I nonfriable ACM, and Category II nonfriable ACM, in accordance with the NESHAP (par. 145(c)(10)).

Before a renovation or demolition that would break up, dislodge or similarly disturb RACM or preclude access to it for subsequent removal, remove all affected RACM (par. 145(c)(1)); except that the affected RACM need not be removed if the RACM is:

- Category I nonfriable ACM not in poor condition or friable.
- Category II nonfriable ACM unlikely to be made friable during or after the work.
- On a facility component encased in concrete or similarly hard material and is kept adequately wet whenever exposed during demolition.
- Untested because it was inaccessible until demolition, and the demolition

has made its removal unsafe. This RACM and any asbestos-contaminated waste must be kept adequately wet until their disposal as asbestos-containing waste.

To remove a facility component containing, covered or coated with RACM, in units or sections:

- During removal, adequately wet RACM exposed, and carefully lower each unit or section (do not drop, throw, slide or otherwise damage or disturb the RACM) (par. 145(c)(2)).
- After removal, strip it of RACM, keeping the RACM adequately wet during stripping, or use a HEPA filtered local exhaust ventilation and control system during stripping (pars. 145(c)(4)).
- If it is a large facility component (e.g., reactor vessel, large tank, steam generator, but not a beam), it need not be stripped if it is encased in leak-tight wrapping with an asbestos danger label and handled without disturbing or damaging the RACM (par. 145(c)(5)).

To strip RACM from a facility component remaining in the facility (par. 145(c)(3)), adequately wet the RACM during stripping, unless the owner or operator:

- Has written approval by the EPA or designated agency (with the approval document on site) based on safety hazard or unavoidable equipment damage, and
- Uses an alternative control method: HEPA filtered local exhaust ventilation and collection system, a appropriate glove bag system, leak-tight wrapping before dismantling, or other EPA-approved method equivalent in its control efficiency (with the approval document on site).

Waste Disposal

RACM waste must meet NESHAP wetting and labeling requirements (par. 150). In general, waste collection, processing, packaging and transporting asbestos-containing waste must yield no visible emissions of asbestos to the outside air.

- This is generally met by adequately wetting asbestos-containing waste:
 - For most waste disposal, the waste is sealed in leak-tight containers or wrapping labeled with OSHA asbestos warning labels, the names of the waste generator, and the location of waste generation (par. 150(a)(1)), and deposited as soon as practical (pars. 150(b)(1),(2)) at a regulated waste disposal site or a facility that converts asbestos waste to asbestos-free waste approved by the EPA and operated as described in sec.155.
 - For demolitions where some RACM was not removed beforehand, the asbestos-containing waste must be kept wet after demolition, during handling and loading for transport. The waste may be sealed in leak-tight containers or wrapping or transported and disposed of in bulk (par. 150(a)(3)).
 - EPA-approved alternative methods of emission control during waste disposal may be used (par. 150(a)(4)).

Vehicles transporting asbestos-containing waste must be visibly marked with asbestos danger signs during loading and unloading of waste (par. 150(c)).

For all asbestos-containing waste being transported off the generating building site, a waste shipment record must be completed by the facility or removal

project owner or operator:

- The waste shipment record must identify the EPA (or its designated agency) office, waste generator, waste transporter(s), and disposal site or conversion facility; and characterize and certify the correctness of the classification, packing, marking and labeling of the waste (par. 150(d)(1)).
- The waste shipment record must be:
 - Signed by representatives of the owner or operator, the transporter(s) and the disposal site or conversion facility.
 - Returned to the owner or operator within 35 days after its departure from the building (par. 150(d)(1),(3)). (If it is not returned within 45 days, this must be reported to the EPA (par. 150(d)(4)).)
 - Retained for at least 2 years (par. 150(d)(5)).

Make all records relating to waste disposal available for EPA inspection (par. 150(e)).

- Exceptions:
 - Nonfriable ACM waste that did not become crumbled, pulverized, or reduced to powder need not meet NESHAP wetting and labeling requirements (par. 150(a)(5)).
 - Category I nonfriable ACM waste that has not nor will not become friable, sanded, ground, cut, or abraded need not be deposited at a regulated waste disposal site or waste conversion facility (par. 150(b)(3)).

DOT Hazardous Material Rules

The Department of Transportation (DOT) issues hazardous material rules (HMR) under the Hazardous Materials Transportation Act, to help ensure that adequate information is available to transporters for their safety and that of the public, about materials being shipped commercially over public roads, waterways and airways.

The HMR does not cover asbestos fixed in a binder such as cement, plastic, asphalt, resins or mineral ore (e.g., non-friable

asbestos-containing material (ACM) that has not become crumbled, pulverized or reduced to powder), or asbestos containing manufactured products (e.g., pipe gaskets). Similarly, the HMR does not cover shipments under 1 pound of friable ACM.

Packaging of ACM for commercial transportation must meet hazardous material rule requirements (found mostly in 49 CFR 171-173) and generally be protective, marked and labeled.

Small quantities:

- Bulk samples over 1 ounce (30 grams) each of friable ACM are subject to the HMR if the whole package contains 1 pound or more.
- A "small quantity" shipment of bulk samples is exempt from the HMR if the samples are each 1 ounce (30 grams) or less in cushioned, securely sealed and packed inner containers of plastic (at least 8 mil (0.2 mm) thick), glass, metal or earthenware.
- The entire, strong package must weigh 64 pounds (29 kg) or less, and be specially marked.
- Packages of air sample filters are not subject to the HMR, since they contain less than 1 pound of friable asbestos.

Limited quantities:

- A "limited quantity" shipment is exempt from marking if it weighs 66 pounds (30 kg) or less with inner packagings up to 11 pounds (5 kg) each in the strong outer packaging.
- It is also exempt from labeling unless it is being shipped by air.

Labeling:

- Packages must generally have a class 9 label, unless excepted. (See "Small quantities," "Limited quantities," and "DOT exceptions".)

Shipping papers:

- Entries used in the hazardous material description on shipping papers are:

RQ,	Reportable Quantity, if 1 lb or more friable asbestos.
WASTE	For waste material, if applicable.
ASBESTOS	Shipping name; for domestic transportation only; see Note below.
MIXTURE,	For asbestos mixed with a binder or filler, etc.
9,	Class 9, Miscellaneous Hazardous Materials, includes asbestos.
NA2212,	North American identification number; for domestic transportation only; see Note below.
PG III	Packing Group; for domestic transportation only; see Note below.
LTD QTY,	Limited quantity, if applicable.
20 OZ	Total quantity of material described; may abbreviate unit.

Note: See international transportation requirements, below.

Marking:

- Packaging must be marked, except for small quantities, limited quantities, and exempt packages. See "Small quantities."

- Entries for non-bulk packagings:

RQ,	Reportable Quantity, if 1 lb or more friable asbestos.
WASTE,	For waste material, if applicable, or use EPA mark.
ASBESTOS,	Shipping name; for domestic transportation only; see Note below.
MIXTURE,	For asbestos mixed with a binder or filler, etc.
NA2212,	North American identification number; for domestic transportation only; see Note below.
JANE Q. PUBLIC INTL. CO. 1234 MAIN ST. OURTOWN, ZZ 99999	Consignee or consignor name and address; except some direct road or train transport.

Note: See international transportation requirements, below.

- A bulk packaging (uncommon for asbestos waste shipments) must be marked with a panel, placard or other display.

Shipping limitation:

- For domestic transportation, asbestos shipments are limited to 440 pounds (200 kg) by aircraft or passenger-carrying railcars, unless the asbestos is stabilized in a binder.

Vehicle marking:

- A vehicle transporting asbestos-containing waste subject to the HMR must be marked with asbestos danger signs during loading and unloading of the waste.

Waste shipment record:

- The record must be completed as required for each shipment of ACM waste subject to the HMR.
- A copy signed by the transporter must be given to the waste generator, (i.e., the building owner or operator, such as a maintenance or abatement contractor) when the waste leaves the building site, and a copy signed by the disposal site must be received in 45 days.
- If the record is not received within 35 days, the transporter or disposal site must be contacted to determine the status of the waste shipment.

International transportation:

- The HMR defines:
 - Crocidolite asbestos as "blue asbestos."
 - Amosite and myosorite asbestos as "brown asbestos."
 - Chrysotile, actinolite, anthophyllite and tremolite asbestos as "white asbestos."
- Shipping limitations:
 - "Blue" or "brown" asbestos, other than a "small quantity" shipment or ACM which is stabilized in a binder (e.g., nonfriable ACM in good condition; see "DOT exceptions"), is forbidden from aircraft or passenger-carrying railcars.
 - "White" asbestos is limited to 440 pound (200 kg) shipments by aircraft or passenger-carrying railcars, unless it is similarly stabilized in a binder.
 - Information: For international transportation, the following United Nations (UN) shipping names, identification numbers and packing groups must be used. (They may also be used for domestic transportation.)
 - WHITE (or BLUE or BROWN) ASBESTOS UN shipping names; see "shipping limitations," below.
 - UN2590 (or UN2212, or UN2212) UN identification numbers.

PG III (or II or I),

Packing Groups; II and III are medium and minor; use II if mixed shipment.

- Marking mixed international shipments: When asbestos of two or more UN descriptions are mixed in an international shipment, each is listed on the mark and shipping papers. For example, a shipping paper might show: "RQ, Waste blue and white asbestos mixture, 9, UN2212 and UN2590, PG II, Ltd Qty, 22 lbs."

DOT Exceptions:

- The HMR does not cover asbestos fixed in a binder such as cement, plastic, asphalt, resins or mineral ore (e.g., non-friable ACM that has not become crumbled, pulverized or reduced to powder), or asbestos containing manufactured products (e.g., pipe gaskets).
- The HMR does not cover shipments under 1 pound of friable ACM.
- Packaging of ACM must meet specific requirements, but need not meet HMR performance oriented packaging specifications for Packing Groups II and III.

Appendix J - Feedback Form

This form is to be used to provide comments to NIBS concerning use of the **Guidance Manual: Asbestos O&M Work Practices**. Comments and suggestions submitted will be considered during future revisions to the manual. Any relevant data derived from the use of the work practices may be submitted.

Date: _____

Comment applies to section: I II III IV V VI VII

Work Practice (if applicable): _____ Level: A B C

Comment/recommendation: _____

Supporting data or information: _____

Submitted by: _____

Phone: _____

Please Return to: NIBS
1201 L Street, N.W. Fourth Floor
Washington, D.C. 20005
(202) 289-7800 FAX: (202) 289-1092

Project Committee

^s Steering Committee Members

Chairman: ^sRalls C. Melotte, AIA - Analytical Design Group, Inc.

Vice-Chairman: ^sCasimer Szewczak - Navy Environmental Health Center

Secretary: ^sRobert J. DeFrank - University of Maryland, College Park

^sWalter D. Anderson - Resilient Floor Covering Institute (RFCI)

Richard A. Baker, CPS - Ramsey-Schilling Consulting Group, Inc.

William Basta - Environmental Science & Engineering, Inc.

Karone Blondin, CIH - GSA, Office of Property Management

Richard Bodane - New York State Office of General Services

Mary Frances Branton - U.S. Department of Veterans Affairs

William J. Brendle - Foster Products Corporation

James O. Bynum - U.S. Army Research Laboratory

Jeffrey C. Camplin, C.S.P. - Camplin Environmental Services, Inc.

Marvin J. Cantor, FAIA - Marvin J. Cantor, AIA & Associates

R. Wayne Crandlemere - R.W. Crandlemere & Associates, Inc.

^sNeil Davis, CIH - Carpenters Health and Safety Fund

R. Landon Doggett - Law Engineering, Inc.

Adrian Ducharme, REM - Aguirre Engineers, Inc.

^sPaul L. Elkourie - BellSouth Telecommunications

James B. Evans - O'Brien & Gere Engineers, Inc.

William M. Ewing, CIH - Compass Environmental, Inc.

Pedro Fernandes - Chastain-Skillman, Inc.

James Fite - White Lung Association

^sWilliam H. Freeman, Jr. - Armstrong World Industries

Neal B. Freuden - EnviroScience-Consultants, Inc.

^sWarren Friedman, Ph.D., CIH - Office of Lead-Based Paint; Dept. of Housing and Urban Development

Christopher K. Gale - Gale/Jordan Associates, Inc.

C. Michael Gambone - James River Environmental Services, Inc.

Robert A. Georgine - Building & Construction Trades Department, AFL-CIO

Joseph D. Green, CIH, CSP - Occupational Health and Hygiene Corporation of America

Paul J. Grogan - New England Power Service Company (NEPSCO)

William N. Hall, Esquire - Winston & Strawn

^sRichard L. Hatfield - Law Engineering, Inc.

George Hatt - Veritech Environmental Services

^sSteve M. Hays, P.E., CIH - Gobbell Hays Partners, Inc.

Paul Heffernan - EC & CA

^sWilliam H. Hoffman - QuestCo, Inc.

Lawrence A. Holbrook - Towson State University

Steven Hughes - PSI

Bethann Jakoboski - Armstrong World Industries, Inc.

Robert Jordan, Ph.D. - U.S. Environmental Protection Agency

Norbert W. Kaleta - National Gypsum Co.

Robert W. Kemp - A & B Asbestos Abatement, Inc.

Jan Koehn - Jan Koehn, M.S., CIH, Inc.

Bill Kojola - Laborers' Health and Safety Fund of North America

Brent Kynoch - AAS Environmental, Inc.

Nora Leyland - Sherman, Dunn, Cohen, Leifer & Yellig
Chris Lovelace - NCDEHNR-Asbestos Branch
Richetta L. Lynch - Law Engineering
George T. Macaluso - Laborers' Health & Safety Fund of North America
Michael McGuinness, CIH/CET - R.K. Occupational & Environmental Analysis, Inc.
Nish Messerian - U.S. Department of Veterans Affairs
Robert Molseed, AIA, FCSI - AIA Master Spec, Inc.
Nicolaus P. Neumann, P.E., C.P.G., DEE - NPN Environmental Engineers, Inc.
Jeannie Nordstrom - U.S. Department of Veterans Affairs
B. J. Pigg - Asbestos Information Association/North America
Rita D. Pittillo - U.S. Department of Veterans Affairs
Robert E. Robb, Jr. - The Environmental Group, Inc.
Gordon L. Rosby - AEC, Inc.
Robert Schmitter - Georgia Tech Research Institute
Scott Schneider, CIH - Center to Protect Workers' Rights
Thom Snyder - Naval Facilities Engineering Command
Charles Swink - Walt Disney World Company
John Sylvester, Jr. - Sylvester & Company
William A. Tippin, IV - EnviroControl, Inc.
Daniel R. Twilley - General Physics Corp.
James L. Werner - U.S. Dismantlement Corporation
Judith A. Whelan - Whelan Associates, Inc.
Michael A. Wiegard - Paul, Hastings, Janofsky & Walker
Chrystene Wyluda - N.J. Department of Community Affairs

Contractor

Roger G. Morse, AIA, Postenkill, N.Y.

NIBS Project Staff

Alexander T. Shaw, III, Program Manager
Pamela W. Towns, Manager - Publications/Membership Records
Patricia Cichowski, Administrative Assistant

CONSULTATIVE COUNCIL

Chairman: William Kojola - Laborers International Union, Health & Safety Department, Washington, DC
Vice Chairman: Marvin J. Cantor, FAIA - Architectural Offices, Alexandria, VA
Secretary: William H. Freeman, Jr. - Armstrong World Industries, Lancaster, PA

Francis W. Biehl, P.E. - Biehl Engineering, Inc., Menomonee Falls, WI
Kenneth E. Bland, P.E. - American Forest & Paper Association, Washington, DC
Liza K. Bowles - NAHB Research Center, Upper Marlboro, MD
Gregory L. F. Chiu - Insurance Institute for Property Loss Reduction, Boston, MA
Dr. Andrew J. Fowell - Bldg&Fire Research Lab, Natl. Institute of Standards & Technology, Gaithersburg, MD
Tom Frost - BOCA International, Country Club Hills, IL
David C. Haataja - Underwriters Laboratories, Inc., Washington, DC
Wayne H. Haffler, AIA - Architect, Washington, DC
David M. Hammerman, P.E. - Howard County Inspections, Licenses and Permits, Ellicott City, MD
David B. Hattis - Building Technology, Inc., Silver Spring, MD
Donald M. Holmes, P.E. - Clapp & Holmes Consulting Engineers, Harrisburg, PA
John B. Kelso, AIA - Kelso & Easter, Inc., Alexandria, VA
Rita E. Knorr - American Society of Civil Engineers, Reston, VA
David L. Ledvinka - Construction Industry Consultants Group, Westerville, OH
Gabor Lorant, FAIA - Lorant Group, Inc., Phoenix, AZ
Joseph R. Loring, P.E. - Joseph R. Loring & Associates, New York, NY
W. Max Lucas, Ph.D. - University of Kansas, Lawrence, KS
Vernon McDougall - United Brotherhood of Carpenters, Health & Safety Fund, Washington, DC
Anthony R. O'Neill - National Fire Protection Association, Arlington, VA
W. Lawrence Schwab, CSP - State Farm Fire & Casualty Company, Bloomington, IL
Dr. Paul A. Seaburg - University of Nebraska, Omaha, NE
Kenneth M. Sedor - Real Estate Support Services, Inc., Minneapolis, MN
Lloyd H. Siegel, FAIA - Department of Veterans Affairs, Washington, DC
Dana K. Smith - Naval Facilities Engineering Command, Alexandria, VA
David A. Swankin - Swankin & Turner, Washington, DC
William A. Tippin, IV - EnviroControl, Inc., Alexandria, VA
Michael E. Wilson - Associated Builders and Contractors, Rosslyn, VA
H. Glenn Ziegenfuss, Ph.D. - American Welding Society, Miami, FL

BOARD OF DIRECTORS

Chairman: Gerald H. Jones, P.E., Kansas City, MO

Vice-Chairman: Thomas I. Young, FCSI, CCS, Smith, Hinchman & Grylls Associates, Inc., Detroit, MI

Secretary: Edward W. Rogers, A.G. Edwards & Sons, Inc., Midland, MI

Treasurer: Michael L. McCune, Argus Real Estate, Inc., Denver, CO

Walter Scott Blackburn, FAIA, Principal, Blackburn Associates Architects, Indianapolis, IN

Jack E. Buffington, P.E., Director, National Rural Transportation Study Center, Univ. of Arkansas, Fayetteville, AR

Dale C. DeHarpport, Principal, Four D. Construction Company, Beaverton, OR

Mary Ellen Fise, General Counsel, Consumer Federation of America, Washington, DC

Warren Friedman, Ph.D., CIH, Mangr. Abatement Technology Research, Ofc. Lead-Based Paint, HUD, Washington, DC
Department of Housing and Urban Development, Washington, D.C.

J. Lee Hauser, P.E., Senior Deputy Commissioner, N.C. Department of Insurance, Raleigh, NC

Steve M. Hays, P.E., C.I.H., Chairman of the Board, Gobbell Hays Partners, Inc., Nashville, TN

William H. Hoffman, President, QuestCo, Inc., Easton, MD

Jack Kelley, P.E., President, Nickerson & O'Day, Inc., Bangor, ME

John H. Miller, P.E., President, Close, Jensen and Miller, P.C., Wethersfield, CT

Monte L. Phillips, P.E., Professor, Dept. of Civil Engineering, University of North Dakota, Grand Forks, ND

Arnold J. Prima, Jr., FAIA, Washington, D.C.

H. Terry Rasco, FAIA, Partner, Witsell Evans & Rasco, P.A., Little Rock, AR

Russell E. Sanders, Central Regional Manager, National Fire Protection Association, Louisville, KY

Walter Smittle, III, Fire Marshal, State of West Virginia, Charleston, WV

David T. Still, Vice President & Gen. Mangr, Building Materials Distribution, Weyerhaeuser Company, Tacoma, WA

Christine M. Wamke, Ph.D., Governmental Affairs Advisor, Hogan & Hartson, Washington, D.C.

NIBS PROFESSIONAL STAFF

David A. Harris, FAIA, President

Bruce E. Vogelsinger, P.E., Vice-President of Planning and Councils

John G. Lloyd, Vice-President of Finance and Administration

Earle W. Kennett, Vice President for CCB Programs

William A. Brenner, AIA, Vice President & Executive Director, Construction Metrication Council

James R. Smith, Executive Director, Building Seismic Safety Council

Thomas R. Hollenbach, Assistant Executive Director, Building Seismic Safety Council

Philip Schneider, AIA, Director, Earthquake Loss Estimation Methodology Study

Neil Sandler, Director of Communications

Layne Evans, Director, CCB Information Systems

Lillian Funk, Director CCB Computer Systems

Alexander T. Shaw, III, Project Manager

Michael D. Cohn, Project Manager

Pamela W. Towns, Manager, Publications/Membership Records

Kelly Sue McCullough, Manager, Building Product PreApproval Program

Edmond H. Gryder, Manager, Technical Resources & Software Development

Alynn C. Skrabalak, CCB Information Services Manager

Kathleen A. Keller, SpecText, Subscriber Services Manager

Robert M. Payn, CCB, Production Manager

Patricia Broughton, CCB, Subscriber Services Manager

Patricia A. Blasi, Manager, Office Services

Claret M. Heider, Technical Writer/Editor

APPENDIX A: RECORD KEEPING FORMS

RECORDKEEPING FORMS

TABLE OF CONTENTS

ACM Work Evaluation Form
Contractor Notification Form
Evaluation of Work Affecting Asbestos-Containing Materials
General Asbestos Awareness Training Form
Initial and Periodic Cleaning Form
Job Request Form for Maintenance Work
Maintenance Work Authorization Form
Medical Authorization for Respirator Use
Medical/Safety Letter
Non-Asbestos-Containing Materials Certification Form
O&M Activity and/or Minor Fiber Release Episode Form
Occupant Information Record
Periodic Surveillance Form
Reinspection of Asbestos-Containing Materials
Reinspection Record
Respirator Fit-Test Log
Respirator Training Record
Response Action Activity and/or Major Fiber Release Episode Form
Short-Term Worker Notification Form
Small-Scale Worker Training Form
Surveillance/Fiber Release Report
Waste Transportation Disposal Record
Work Permit/Purchase Order Request
Worker Medical Surveillance Record
Worker Training Record

ACM WORK EVALUATION FORM

Facility: _____

Location of work performed: _____

Date of Work: _____ Approval Form No.: _____

Description of Work: _____

Evaluation of Work Practices: _____

Evaluation of Equipment and Procedures to protect workers: _____

Air Sample Results

Name and Results: _____

Name and Results: _____

Name and Results: _____

Storage Location: _____

Disposal Site and Date: _____

Signed: _____
(Asbestos Program Manager)

Date: _____

CONTRACTOR NOTIFICATION FORM

To comply with relevant federal and state laws, and the Facilities Operations and Maintenance Policies and Procedures, facility will provide the Contractor with data regarding the locations of asbestos-containing material (ACM). This will be done prior to the Contractor entering any building under the facility's jurisdiction.

Please complete this form and return to:

I, _____, representing and having authority for _____ (company), hereby indicate and agree that a representative of _____ (name & title), has provided me information regarding the specific locations and materials that are asbestos-containing and which may be encountered or have the potential of being encountered during the course of activities on project _____ (name or number) in _____ (building).

I agree that neither I, nor any of my employees, agents, subcontractors, or other individuals or entities over whom I have any responsibility or control will disturb ACM as found in the Asbestos Survey for the above-mentioned building.

I further understand and agree that should I, my employees, agents, subcontractors or other individuals or entities over whom I have control, encounter any material(s) suspected of containing asbestos, said material(s) shall not be disturbed without first notifying the facility's Asbestos Program Manager, or appointed designee, and receiving approval that such material may be disturbed.

Print Name

Signature

Company

Position

Date

EVALUATION OF WORK AFFECTING ASBESTOS-CONTAINING MATERIALS

This evaluation covers the following maintenance work:

Location of work (address, building, room number(s), or general description):

Date(s) of Work: _____

Description of work: _____

Work Approval Form No.: _____

Evaluation of work practices employed to minimize disturbance of asbestos:

Evaluation of work practices employed to contain released fibers and to clean up the work area:

Evaluation of equipment and procedures used to protect workers:

Personal air monitoring results (in-house worker or contract?)

Worker Name: _____ Results: _____

Worker Name: _____ Results: _____

Handling or storage of ACM waste: _____

Signed: _____ Date: _____

(Asbestos Program Manager)

INITIAL AND PERIODIC CLEANING FORM

Facility: _____

Building Name: _____

Type of Cleaning: _____ Initial _____ Periodic _____ Other

Name of people performing cleaning:

Cleaning Methods (check methods used):

_____ HEPA Vacuumed _____ Wet Methods _____ Proper Disposal

_____ Protective Equipment Used

Written description of cleaning methods: _____

Location of cleaning: _____

Response Team Leader certifies that the above cleaning was done to comply with the relevant Federal and State laws and the Facility's Manual:

Print Name Signature Date

Contractor Representative certifies that the above cleaning was done to comply with the Facility's Cleaning Specifications/Requirements:

Print Name Signature Date

Asbestos Program Manager:

Print Name Signature Date

JOB REQUEST FORM FOR MAINTENANCE WORK

Name: _____ Date: _____

Telephone No.: _____ Job Request No.: _____

Requested Starting Date: _____ Anticipated Finish Date: _____

Address, building, and room number(s) (or description of area) where work is to be performed:

Description of work:

Description of any asbestos-containing material that might be affected, if known (include location and type): _____

Name and telephone number of requestor: _____

Name and telephone number of supervisor: _____

Submit this application to: _____
(Asbestos Program Manager)

NOTE: An application must be submitted for all maintenance work whether or not asbestos-containing material might be affected. An authorization must then be received before any work can proceed.

_____ Granted (Job Request No. _____)

_____ With Conditions*

_____ Denied

*Conditions: _____

MAINTENANCE WORK AUTHORIZATION FORM

No.: _____

Authorization

Authorization is given to proceed with the following maintenance work:

Presence of Asbestos-Containing Materials

- _____ Asbestos-containing materials are not present in the vicinity of the maintenance work.
- _____ ACM is present, but its disturbance is not anticipated; however, if conditions change, the Asbestos Program Manager will reevaluate the work request prior to proceeding.
- _____ ACM is present, and may be disturbed.

Work Practices if Asbestos-Containing Materials are Present

The following work practices shall be employed to avoid or minimize disturbing asbestos:

Personal Protection if Asbestos-Containing Materials are Present

The following equipment/clothes shall be used/worn during the work to protect workers:

(manuals on personal protection can be referenced)

Special Practices and/or Equipment Required:

Signed: _____
(Asbestos Program Manager)

Date: _____

MEDICAL AUTHORIZATION FOR RESPIRATOR USE

Employer: _____

Employee _____ Social Security Number _____ Date of Birth _____

Supervisor _____ Department _____

Check Types of Respirator(s) to be used:

- | | |
|--|---|
| <input type="checkbox"/> Atmosphere-Supplying Respirator | <input type="checkbox"/> Continuous-Flow Respirator |
| <input type="checkbox"/> Open-Circuit SCBA | <input type="checkbox"/> Closed-Circuit SCBA |
| <input type="checkbox"/> Supplied-Air Respirator | <input type="checkbox"/> Combination Air-Line SCBA |
| <input type="checkbox"/> Air-Purifying (non-powered) | <input type="checkbox"/> Air-Purifying (powered) |

Level of work effect (mark one):

Light Moderate Heavy Strenuous

Extent of Use (circle):

1. On a daily basis.
2. Occasionally, but more than once a week.
3. Rarely, or for emergency situations only.

Length of Time of Anticipated Effort in Hours: _____

Special Work Considerations (i.e., high places, temperature, hazardous material, protective clothing, etc. If none, state "none".) _____

Asbestos Program Manager _____ Date _____
(or appointed designee)

Employee: _____

Have you ever worn a respirator before? Yes No

If yes, describe any difficulties noted with respirator use: _____

Employee Signature _____ Date _____

MEDICAL AUTHORIZATION FOR RESPIRATOR USE (Continued)

Physician's Evaluation: _____

Class (circle):

1. No restrictions on respirator use.
2. Some specific use restrictions.
3. No respirator use permitted.

Restrictions: _____

Examining Physician's Signature

Date

MEDICAL/SAFETY LETTER

Page 1 of 2

To Whom It May Concern:

The following is a description of our employee's duties as they relate to the employee's exposure to airborne asbestos.

_____ is a _____ in our facility's maintenance department. His/her primary asbestos-related job duties include the following:

- Small-scale, short-duration activities.
- Minor fiber release episode clean-ups.
- Initial cleaning.

Small-Scale, Short-Duration Activity

Our employee may perform small-scale, short-duration asbestos abatement activities. Normally, this work involves tasks such as, but not limited to:

- Removal, encapsulation, enclosure, or repair of asbestos-containing materials in small quantities.
- Replacement of asbestos-containing gaskets on valves and other items.
- Installation of electrical conduits or other items through or proximate to asbestos-containing materials.

The anticipated exposure levels while working on small-scale, short-duration activities is expected to be below 0.1 fibers per cubic centimeter (f/cc) based on an 8-hour TWA. Of course, our employees are required to wear a negative-pressure respirator and disposable coveralls, at a minimum, every time that they handle ACM.

Minor Fiber Release Episode

Our employee may perform clean-up of minor fiber releases. The anticipated exposure levels while cleaning up a minor fiber release episode is expected to be below 0.1 f/cc based on an 8-hour TWA. Our employees are required to wear, at a minimum, a negative-pressure respirator and disposable clothing while performing this work.

Initial Cleaning

Our employee may perform initial cleaning in buildings with friable ACM. The anticipated exposure levels while cleaning up a minor fiber release episode is expected to be below 0.1 f/cc based on an 8-hour TWA. Our employees are required to wear, at a minimum, a negative-pressure respirator and disposable clothing while performing this work.

If information from previous medical examination of the employee is available, this information will be brought to the exam with the employee.

MEDICAL/SAFETY LETTER (Continued)

A copy of the following OSHA regulations have also been provided:

- 29 CFR 1926.1101
- Appendix D
- Appendix E
- Appendix I

Important Note to Physician: To comply with Regulation 1926.1101 of OSHA, the Physician shall not reveal in the written opinion given to the employer, specific findings or diagnoses unrelated to occupation exposure to asbestos, tremolite, anthophyllite, or actinolite.

If you have any questions or concerns regarding this information, please contact me at the below address or phone:

Name _____ Phone _____

Street _____ City _____ State _____ Zip _____

Facility _____

Documentation

Name of Clinic _____ Phone _____

Street _____ City _____ State _____ Zip _____

Signature of Clinic Representative _____ Date _____

Signature of Employee _____ Date _____

NON-ASBESTOS-CONTAINING MATERIALS CERTIFICATION FORM

Facility: _____

Building Name: _____

Contractor Name and Address:

Name Phone

Street City State Zip

Scope of contracted activities: _____

Certificate Statement:

I, _____ (name), representing and having authority for _____ (company), hereby certify that any and all products/materials which will be and/or have been installed or introduced into the above-mentioned building for project _____ (name or number) are non-asbestos-containing (i.e., less than 1% asbestos by weight).

Print Name

Signature

Company

Position

Date

O&M ACTIVITY and/or MINOR FIBER RELEASE EPISODE FORM

Facility: _____

Name of Building: _____

Type of Activity: _____ O&M _____ Minor Fiber Release _____ Both

Completion Dates of Activity: _____

Room Number or Location: _____

Type of Material: _____

Reason for Activity/Fiber Release: _____

List of Personnel Performing Activity:

Response Team Member certifies that the above activity was conducted to comply with the Facility's O&M Plan:

Print Name Signature Date

Name and location of disposal site for ACM:

Name Phone

Street City State Zip

Response Team Member who released waste to asbestos-waste-transportation person:

Print Name Signature Date

OCCUPANT INFORMATION RECORD

Document Number: _____

Date: _____, 19____

Receipt acknowledging that I have been informed of the presence of asbestos-containing building materials in:

Building Number and Name: _____

Building Location: _____

I further acknowledge that the information provided to me included the following:

1. The locations of asbestos-containing materials to which I might have access in the normal course of my presence in the building.
2. The hazards to health presented by asbestos.
3. Appropriate behavior in the presence of asbestos-containing materials which will prevent or reduce the potential hazard.
4. Notification procedures which I must follow in the event I observe a possible change in the condition of any of the asbestos-containing materials.
5. Safety procedures which I am to follow in the event of an emergency which might involve the asbestos-containing materials.

My reason for being in the building is: _____

My signature in the acknowledgment of the above.

Print Name

Employer Name

Phone No.

Employer Address

PERIODIC SURVEILLANCE FORM

Building Information

Building Number: _____

Building Name: _____

Location: _____

Area Information

Number: _____

Location: _____

Changes in Condition: _____

Material Information: _____

Comments: _____

Inspected On: _____ By: _____

(please print)

Signature: _____

REINSPECTION OF ASBESTOS-CONTAINING MATERIALS

Location of asbestos-containing material (address, building, room, or general description):

Type of asbestos-containing material(s):

1. Sprayed- or troweled-on ceilings or walls
2. Sprayed- or troweled-on structural members
3. Insulation on pipes, tanks, or boiler
4. Other (describe):

Abatement Status:

1. The material has been encapsulated____. enclosed____. neither____. removed____.

Assessment:

1. Evidence of physical damage: _____

2. Evidence of water damage: _____

3. Evidence of delamination or other damage: _____

4. Degree of accessibility of the material: _____

5. Degree of activity near the material: _____

6. Location in an air plenum, air shaft, or airstream: _____

7. Other observations (including the condition of the encapsulant or enclosure, if any): _____

Recommended Action: _____

Signed: _____
(evaluator)

Date: _____

REINSPECTION RECORD

Reinspection Date: _____

Facility: _____

*Building Name Or Number: _____

*Material Reinspected: _____

*Homogeneous Area: _____

Has the condition of this material changed since the last inspection? Yes No

Explain: _____

Has the friability of this material changed since the last inspection? Yes No

Explain: _____

Has the potential for disturbance of this material changes since the last inspection? Yes No

Explain: _____

As a result of this reinspection, has the recommended response action for this material changed? Yes No

Explain: _____

Name of person performing reinspection: _____

AHERA Inspector certification number: _____

Describe personal protection worn during reinspection: _____

(Immediately notify the Asbestos Management Coordinator, or appointed designee, of any changes.)

*Use data as found in the Facility's Prioritization Report, unless building was not included.

RESPONSE ACTION ACTIVITY and/or MAJOR FIBER RELEASE EPISODE FORM

Facility: _____

Name of Building: _____

Type of Activity: _____ Response Action _____ Major Fiber Release _____ Both

Response Action Data

Material Damage Category:

- | | |
|---|---|
| _____ Damaged Friable Surfacing ACM | _____ Damaged Misc. ACM |
| _____ Significantly Damaged Friable Surfacing ACM | _____ Significantly Damaged Friable Misc. ACM |
| _____ Damaged or Significantly Damaged TSI | _____ Potential for Damaged ACM |
| _____ Potential or Significantly Damaged ACM | _____ Debris/Clean-up |

Written Description of Location and Activity: _____

Reason for selecting Response Action or Clean-up Procedure: _____

Schedule: _____

Contractor Data

Name and address of Contractor who performed activity:

Name Phone

Street City State Zip

RESPONSE ACTION ACTIVITY and/or MAJOR FIBER RELEASE EPISODE FORM (Continued)

Asbestos Contractor License No.: _____

Asbestos Supervisor On-site: _____

Accreditation No.: _____

Asbestos Abatement Crew (Name and Accreditation No.)

_____	_____
_____	_____
_____	_____
_____	_____

Name, address and location of disposal site of ACM:

Clearance Data

Locations and results of air samples taken:

<u>Location</u>	<u>Result</u>
_____	_____
_____	_____
_____	_____
_____	_____
_____	_____
_____	_____

Method of Analysis: ____PCM ____TEM

Date samples taken: _____

Name and address of company taking samples:

Name Phone

Street City State Zip

RESPONSE ACTION ACTIVITY and/or MAJOR FIBER RELEASE EPISODE FORM (Continued)

Name and signature of air sample collectors:

Print Name Signature Date

Print Name Signature Date

Date of analysis: _____

Location of analysis: _____ On-Site _____ Other.

Explain: _____

Name and address of laboratory analyzing samples:

Name Phone

Street City State Zip

Name and signature of person performing air sample analysis:

Print Name Signature Date

Statement of Laboratory's qualifications:

SHORT-TERM WORKER NOTIFICATION FORM

Facility: _____

Building Name or Number
Where Work is to be Performed: _____

Description of Work to be Performed: _____

Date of Work to be Performed: _____

Name of Person Performing Work: _____

I have reviewed the facility's Asbestos Survey regarding the location(s) of asbestos-containing material (ACM) and have been cautioned against any disturbance and damage of these materials.

If my work requires the disturbance or damage of any ACM, or if I accidentally disturb or damage the material, I will stop work and immediately inform the Asbestos Program Manager, or appointed designee, _____.

Print Name

Signature

Company

Position

Date

SURVEILLANCE/FIBER RELEASE REPORT

____ 6 Month Surveillance ____ Fiber Release Episode Report

Building No. and Name: _____

Address: _____ Owner: _____

Material Location: _____ Date: _____

Description of ACM Evaluated: _____

Information obtained from Facility Asbestos Report:

Photo Reference No.: _____	Homogeneous Material Sample Area No.: _____
Identified (sample ID): _____	<input type="checkbox"/> Assumed <input type="checkbox"/> Sample Taken
Previous Assessment Category:	<input type="checkbox"/> Friable <input type="checkbox"/> Non-Friable <input type="checkbox"/> No Damage <input type="checkbox"/> Potential Damage
	<input type="checkbox"/> Damage <input type="checkbox"/> Potential Significant Damage <input type="checkbox"/> Significant Damage

Description of Changes Observed: _____

Designated Person: _____ Surveyor: _____

Description of ACM Evaluated: _____

Information obtained from Facility Asbestos Report:

Photo Reference No.: _____	Homogeneous Material Sample Area No.: _____
Identified (sample ID): _____	<input type="checkbox"/> Assumed <input type="checkbox"/> Sample Taken
Previous Assessment Category:	<input type="checkbox"/> Friable <input type="checkbox"/> Non-Friable <input type="checkbox"/> No Damage <input type="checkbox"/> Potential Damage
	<input type="checkbox"/> Damage <input type="checkbox"/> Potential Significant Damage <input type="checkbox"/> Significant Damage

Description of Changes Observed: _____

Designated Person: _____ Surveyor: _____

Description of ACM Evaluated: _____

Information obtained from Facility Asbestos Report:

Photo Reference No.: _____	Homogeneous Material Sample Area No.: _____
Identified (sample ID): _____	<input type="checkbox"/> Assumed <input type="checkbox"/> Sample Taken
Previous Assessment Category:	<input type="checkbox"/> Friable <input type="checkbox"/> Non-Friable <input type="checkbox"/> No Damage <input type="checkbox"/> Potential Damage
	<input type="checkbox"/> Damage <input type="checkbox"/> Potential Significant Damage <input type="checkbox"/> Significant Damage

Description of Changes Observed: _____

Designated Person: _____ Surveyor: _____

SURVEILLANCE/FIBER RELEASE REPORT (Continued)

Material Location: _____ Date: _____

Description of ACM Evaluated: _____

Information obtained from Facility Asbestos Report:

Photo Reference No.:	_____	Homogeneous Material Sample Area No.:	_____	
Identified (sample ID):	_____	<input type="checkbox"/> Assumed	<input type="checkbox"/> Sample Taken	
Previous Assessment Category:	<input type="checkbox"/> Friable	<input type="checkbox"/> Non-Friable	<input type="checkbox"/> No Damage	<input type="checkbox"/> Potential Damage
	<input type="checkbox"/> Damage	<input type="checkbox"/> Potential Significant Damage	<input type="checkbox"/> Significant Damage	

Description of Changes Observed: _____

Designated Person: _____ Surveyor: _____

Description of ACM Evaluated: _____

Information obtained from Facility Asbestos Report:

Photo Reference No.:	_____	Homogeneous Material Sample Area No.:	_____	
Identified (sample ID):	_____	<input type="checkbox"/> Assumed	<input type="checkbox"/> Sample Taken	
Previous Assessment Category:	<input type="checkbox"/> Friable	<input type="checkbox"/> Non-Friable	<input type="checkbox"/> No Damage	<input type="checkbox"/> Potential Damage
	<input type="checkbox"/> Damage	<input type="checkbox"/> Potential Significant Damage	<input type="checkbox"/> Significant Damage	

Description of Changes Observed: _____

Designated Person: _____ Surveyor: _____

Description of ACM Evaluated: _____

Information obtained from Facility Asbestos Report:

Photo Reference No.:	_____	Homogeneous Material Sample Area No.:	_____	
Identified (sample ID):	_____	<input type="checkbox"/> Assumed	<input type="checkbox"/> Sample Taken	
Previous Assessment Category:	<input type="checkbox"/> Friable	<input type="checkbox"/> Non-Friable	<input type="checkbox"/> No Damage	<input type="checkbox"/> Potential Damage
	<input type="checkbox"/> Damage	<input type="checkbox"/> Potential Significant Damage	<input type="checkbox"/> Significant Damage	

Description of Changes Observed: _____

Designated Person: _____ Surveyor: _____

WASTE TRANSPORTATION DISPOSAL RECORD

Landfill name and location:

Name Phone

Street City State Zip

Hauler name and address:

Name Phone

Street City State Zip

Amount of the material hauled (weight and volume): _____

Type of container utilized: _____

Containers labeled? Yes No

Containers free from visible debris? Yes No

Landfill Operator certifies that the above statements are true and that the landfill has been permitted for the disposal of asbestos:

Print Name Signature Date

Facility: _____

WORK PERMIT/PURCHASE ORDER REQUEST

File No./Functional Spaces: _____ Date: _____

Building No. and Name: _____

Address: _____ Owner: _____

Description of work to be performed: _____

Type: Scheduled Maintenance/Repair Scheduled Remodeling/Reconfiguration
 Scheduled Reconstruction/Demolition Scheduled Asbestos Abatement
 EMERGENCY Repair/Clean-up (Minor Fiber Release) EMERGENCY Repair/Clean-up (Major Fiber Release)

Locations (functional spaces) in which work is to be performed: _____

Designated Person's Authorization: According to the available records, the work described above will involve the disturbance of asbestos-containing building materials. I hereby certify that according to the available records the work described above shall not disturb asbestos-containing building materials.

Signature _____ Title _____ Date _____

Project Designer: _____ State & Accreditation No.: _____

Start Date _____ Completion Date _____ P.O. No. _____ Contract _____

Contractor _____ Address _____

Registered Licensed & Certified

Methods: Wet Methods Wet-Wiping
 HEPA Vacuuming Critical Barrier Sealed
 Wall Plastic Floor Plastic Surfactant
 Negative Air Machines @ ()cfm; No.: _____
 Glovebag Mini-Enclosure Vacu-Loader
 Local exhaust Water Filtration
 Other _____

Accredited Worker/Supervisor	State	Accreditation No.

Repair Decon Encapsulate Enclosure Removal Preventive Measure

Reasoning: _____

Waste Generated (cubic yards) _____ Number of Bags: _____ Manifest No.: _____ Date: _____
 Landfill Address: _____

Air Sampling Technician _____ Signature _____ Firm _____

Sample ID	Sample Location	Date	Result	Sample ID	Sample Location	Date	Result

Method: _____

Laboratory: _____

WORKER MEDICAL SURVEILLANCE RECORD

Page ____ of ____

Individual's Name:	Individual's Identification No.:
Permanent Street Address:	Emergency Contact Person:
City:	Emergency Contact Phone No.:
State and Zip:	Attending Physician:
Home Phone No.:	Attending Physician's Phone No.:

Respirator Fit-Testing

Medical Approvals		Test Conducted By	Date	Manufacturer's Data	
Date	Physician			Make	Model

Medical Examination History

Date	Physician	Type of Examination	Reason	Results on File at Location

WORKER TRAINING RECORD

Page ____ of ____

Individual's Name:	Individual's Identification No.:
Permanent Street Address:	Emergency Contact Person:
City:	Emergency Contact Phone No.:
State and Zip:	Attending Physician:
Home Phone No.:	Attending Physician's Phone No.:

Asbestos Training History

Course Date	Course Location	Course Title	Training Center Name	Hrs. of Instruction	Certificate No.

This individual is qualified to perform the following type(s) of asbestos-related work (circle):

1. Restricted to maintenance work which does not involve the disturbance of asbestos-containing building materials.
2. May perform small-scale, short-duration work as defined by the applicable rules and regulations, under proper supervision.
3. May perform small-scale, short-duration work as defined by the rules and regulations, and is qualified to supervise other workers performing the same type of work.
4. May perform work in any type of asbestos removal project under proper supervision.
5. May perform work on any type of asbestos removal project and is qualified to supervise others performing the same type of work.

Signature _____ Title _____ Date _____

APPENDIX B: TERMS AND ABBREVIATIONS

TERMS AND ABBREVIATIONS

ACBM: Asbestos-containing building materials.

Accessible: When referring to ACM, accessible means the material is subject to disturbance by building occupants, custodial, or maintenance personnel in the course of their normal activities.

Accredited or Accreditation: Refers to a person, firm, or laboratory having met the requirements found in Section 206 of Title II of the AHERA Act.

ACM: Asbestos-containing materials.

Acoustical Material: Material which often contains asbestos, vermiculite, and perlites that has been applied to ceilings or walls to dampen sound.

AHERA: The Asbestos Hazard Emergency Response Act of 1986 (40 CFR Part 763). Final rule as published in the Federal Register, Volume 52, No. 210.

Air Plenums: A space above a ceiling used to circulate or condition air throughout the adjacent areas.

Air Samples: Samples of airborne fibers taken by drawing air through an appropriate filter media which traps the fibers. This sample is then analyzed by polarized light or electron microscopy.

Amosite: Brown asbestos, with brittle fibers often used for extreme thermal conditions.

APM: Asbestos Program Manager.

Approved Shower: A shower used for decontamination, with waste water filtered down to the 5 micron range, and capable of supplying hot water at a temperature of 100 degrees F. or greater.

APR: Air-Purifying Respirator.

Asbestos: A naturally occurring mineral which includes chrysotile, actinolite, anthophyllite, tremolite, or crocidolite in fibrous structure, or any combination of these that have been chemically treated or altered, as determined by polarized light microscopy (PLM).

Asbestos-Containing Material (ACM): When referring to a building means any material or product that contains greater than 1% of asbestos.

Asbestos-Containing Building Material (ACBM): Is surfacing ACM, thermal ACM, or miscellaneous ACM that is found in or on the structural members of a building.

Asbestos Debris: Pieces of ACBM that can be identified by color, texture, or fiber content as originating from adjacent ACM.

Asbestos Fiber: Is any fiber of chrysotile, actinolite, amosite, tremolite, anthophyllite, crocidolite longer than 5 micrometers and with a length-to-width ratio (aspect) of greater than 3 to 1.

Asbestos Management Plan: A document to assist in administering the asbestos program in a facility.

Asbestosis: A chronic disease during which the lungs become scarred as a result of a biological reaction to the inhalation of asbestos fibers.

ASHAA: Asbestos School Hazard Abatement Act of 1984.

Authorized Person: Is any person authorized by an employer, and required by work duties to be present in regulated areas or activities.

Bulk Samples: Samples of suspect asbestos-containing material. These samples are then analyzed by Polarized Light Microscopy (PLM).

CFR: Code of Federal Regulations.

Chrysotile: White asbestos, fine, silky, flexible fibers with high tensile strength.

Clean Room: Is an uncontaminated room having facilities for the storage of employees' street clothing, and uncontaminated supplies and equipment.

Competent Person: Is a person capable of identifying existing asbestos hazards in the workplace, and who has the authority to take prompt corrective measures.

Condition Factors: A description of the ACM's condition.

Crawl Space: An area of a building only a few feet high, often below the ground level, but above the ground.

Crocidolite: Blue asbestos, stronger than most asbestos minerals; has brittle fibers.

Decontamination Room: Is an enclosed area adjacent and connected to the regulated area consisting of an equipment room, shower area, and clean room which is used for the decontamination of personnel, equipment, and materials.

Doffing: The action of taking off personal protective equipment.

Donning: The action of putting on personal protective equipment.

Employee Exposure: Exposure to airborne asbestos, actinolite, tremolite, anthophyllite, or any combination of these minerals that would occur if the employees were not wearing respiratory protection.

Encapsulation: The treatment of ACM/ACBM with a material that surrounds or embeds the asbestos fibers in an adhesive matrix to prevent the release of those fibers.

Bridging: Encapsulation technique that creates a membrane on the ACM surface.

Penetration: Encapsulation technique where the encapsulating mixture penetrates the ACM material and binds its components together.

Enclosure: Is an airtight impermeable, permanent barrier around ACM/ACBM to prevent the release of asbestos into the air.

Equipment Room: A contaminated room located within the decontamination area, that is supplied with impermeable bags for the disposal of contaminated personal protective clothing and equipment.

F/CC: Fibers per cubic centimeter. A measurement to express the level of fibers in the air.

Facility: Is any institutional, commercial, public, industrial, or residential structure, installation or building; any ship; any active waste disposal sites.

Facility Component: Any pipe, duct, boiler, tank, reactor, turbine or furnace at or in a facility; or any structural members of a facility.

Fiber Release Episode: Is any uncontrolled or unintentional disturbance of ACM/ACBM that results in a visible emission.

Fibrils: A small bundle of individual fibers.

Fireproofing: Material sprayed or troweled onto facility components or structural members to prevent or retard their loss of strength during a fire. Often contains asbestos.

Fit-Testing: The action, either by qualitative or quantitative measurement, of ensuring a respirator has a proper seal to the workers' face and is functioning properly.

Friable: Easily crumbled by hand pressure.

Friable Asbestos Material: Is any material, containing greater than 1% asbestos, that can be crumpled, pulverized or reduced to powder, when dry, by hand pressure.

Glovebag: A poly bag used to remove pipe insulation.

Hazard: Is any circumstance, mechanism, or event which has the potential to create injury or loss.

HEPA: High Efficiency Particulate Absolute. Those high efficiency filters capable of trapping and retaining 99.97% of all mono-dispersed fibers greater than 0.3 micrometers in diameter.

Homogeneous Area: An area that is determined to be uniform in color, texture, depth, content, or age.

Inadvertent Contamination: The disturbance of ACM/ACBM not caused intentionally by individuals or parties involved in the project.

Inspection: The process of locating ACM, determining its condition, and reporting the results. This inspection is the basis of the management plan.

Latency: The period of a disease without manifestation of symptoms.

Magnesia: A type of thermal insulation, usually white and often pre-formed into squares or rectangles, often contains asbestos.

Mechanical Area: An area of a facility not normally accessed by the public; often contains HVAC equipment, boilers, heat exchangers, tanks, pipes, ducts and other mechanical equipment.

Medical Surveillance Program: A program to ensure that personnel are physically and psychologically able to wear respiratory protection equipment, and are able to perform asbestos related activities.

Mesothelioma: A cancer of the lining of the lungs (pleural) or abdominal (peritoneal) cavity.

Miscellaneous ACM: Miscellaneous material that contains greater than 1% asbestos.

Miscellaneous Material: Interior building materials on structural members or fixtures, such as floor and ceiling tiles, and does not contain thermal system or surfacing material.

MSDS: Material Safety Data Sheets. A technical document or report that provides precautions, protective measures, chemical makeup (active ingredients), and steps to take after a release. A primary source of information concerning chemical hazards.

Mudded Joint Fittings: Plaster compound packed onto pipe joints and around valves, tees, and pumps for thermal insulation; often contains asbestos.

Negative Air: A reduced pressure, or pressure differential process where the air pressure in the work area is less than that outside the work area. The differential is measured either by air changes per hour, or in inches of water current (vacuum).

NESHAPS: National Emission Standards for Hazardous Air Pollutants.

NIOSH: National Institute of Occupational Safety and Health. The agency who sets the standards for respirators and other protective equipment.

Non-Friable: That material in a building which, when dry may not be crumbled, pulverized, or reduced to powder by hand pressure.

O&M: Operations and Maintenance.

Operations and Maintenance Program (O&M): A program aimed at maintaining friable ACM/ACBM through training, awareness, and standardized work practices. An outreach of a comprehensive O&M program is the cleanup and repair of previously damaged ACM, as well as the prevention of further damage.

OSHA: The Occupational Safety and Health Administration of the United States Department of Labor.

Outside Air: The air outside the regulated area; often called "ambient".

Packing: Material applied to tanks, boilers, ducts, and air handlers for thermal insulation; often contains asbestos.

PAPR: Powered Air-Purifying Respirator.

PCM: Phase Contrast Microscopy. A method used to analyze air samples for the presence of airborne fibers.

PEL: Permissible Exposure Limit. A level of airborne asbestos above which no unprotected employee shall be exposed. Currently the PEL (Federal) is 0.1 F/CC of air as an 8-hour time weighted average. See 29 CFR 1926.1101.

Planned Renovation: A renovation operation, or a number of such operations in which the amount of friable asbestos material to be removed or stripped within a given period of time can be predicted. Individual non-scheduled operations are included if a number of such operations can be predicted to occur during a given period of time based on previous operation experience.

PLM: Polarized Light Microscopy. A method used to analyze bulk samples for the presence of asbestos.

Potential Damage: Circumstances in which:

1. Friable ACBM is in an area regularly used by building occupants, including maintenance personnel, in the course of their normal duties, and
2. There are indications that there is a reasonable likelihood that the material or its covering will become damaged, deteriorated, or delaminated due to factors such as changes in building use, changes in operations and maintenance practices, changes in occupancy, or recurrent damage.

Preventive Measures: Are actions taken to reduce the likelihood of disturbances, releases, or damaging of identified or suspect ACM.

Regulated Areas: Areas that exceed or may exceed airborne concentrations beyond permissible exposure limits of 0.1 F/CC.

Re-Inspection: A periodic re-evaluation of the ACM's condition of presence over a regular time period.

Removal: A response action where the asbestos is stripped or permanently removed.

Renovation: Is the modification of any existing structure or portion thereof where exposure to airborne asbestos may result.

Repair: Is the restructuring, overhauling, rebuilding or reconditioning of structures or surfaces where asbestos is present.

Respirator: A device worn over the mouth and nose to prevent the inhalation of noxious substances.

Respiratory Protection Plan: A program to provide the information, training, and equipment necessary for proper respiratory protection while working with ACM.

Response Action: Methods of controlling asbestos that include: repair, removal, encapsulation, O&M, or enclosure.

Routine Maintenance Area: An area, such as boiler room or mechanical room, not normally frequented by the public in which maintenance employees or contract workers regularly conduct maintenance activities.

SEM: Scanning Electron Microscopy. A method to analyze air or bulk samples for the presence of asbestos.

Serpentine: A major classification of asbestos minerals.

Surfacing Material: That material which is sprayed-on, troweled-on, or otherwise applied as acoustical plaster, fireproofing, or as decorative finishes.

TEM: Transmission Electron Microscopy. Currently the most definite analysis method for the determination of asbestos presence in air, water, or bulk samples.

Thermal System Insulation: Material applied to pipes, fittings, boilers, interior structures, and ducts to prevent heat loss or gain, condensation or for other purposes.

TSCA: Toxic Substance Control Act.

TWA: Time Weighted Average. An average concentration of material over a set period of time.

TYVEK: A brand name for disposable clothing worn while working with asbestos.

USEPA: United States Environmental Protection Agency. The agency charged with implementing AHERA.

Visible Emissions: Any emissions, which are visually detectable without special instruments coming from asbestos-containing material.

Wet Cleaning: A cleaning technique where the material is kept wet, and/or towels or mops are used to reduce the potential of the material becoming airborne.

SECTION 8

INITIAL NOTIFICATION

METHOD OF NOTIFICATION OF ASBESTOS-CONTAINING MATERIALS IN SCHOOL FACILITIES

Initial notification was accomplished as follows:

- Staff/Faculty: A copy of the enclosed letter was sent to the parents/guardians of all enrolled students, all District employees, District PTA Groups, District PTO Groups, Governing Board, and Cabinet Members on **(for example: October 2, 1989)**. Additionally, a copy of the letter has been posted in the **(for example: Staff/Faculty Office area)**.
- Outside Contacts: Will be notified of ACM or ACBM prior to any work that could disturb any suspect materials.

To: All Parents
All District Employees
District P.T.A. Groups
District P.T. O. Groups

C.A.C.
E.S.P
P.E.A.A.
P.E.C.T.A.

Governing Board
Cabinet Members

Re: ASBESTOS NOTIFICATION – NOTICE TO THE PUBLIC

The Environmental Protection Agency (EPA) Asbestos-Containing Materials (ACM) in Schools Final Rule and Notice (40 CFR Part 763.84c) requires the Local Education Agency (LEA) to “insure that workers and building occupants, or their legal guardians, are informed at least once each school year about inspections, response actions, and post-response action activities, including periodic re-inspections and surveillance activities that are planned or in progress.”

A copy of the Asbestos Management Plan is located in each facility’s main office. All individuals and organizations are encouraged to read this document and become familiar with the following:

- What Asbestos is and how it is typically used;
- Health effects associated with exposure;
- What type(s) of ACM are present in the facility;
- The exact location(s) of these materials;
- How individuals can avoid disturbing ACM;
- How to recognize and report damage;
- How Custodial and maintenance personnel are dealing with these materials to prevent fiber release;
- What will be done periodically and over the long run to protect the health and safety of the building occupants;
- Name and telephone number of the person responsible for asbestos-related activities in the facility.

Any individual and/or organization requiring information about the District's Asbestos Management Plans should contact (**for example: Giacomo Musella, LEA**) (Kyrene School District No. 28 designated person) at (**enter phone number**).

All Asbestos Management Plans are to remain in the designated locations for public inspection and information.

Any alterations to these plans shall be done by the Maintenance and Operations Department only.

Sincerely,

(Enter Name and Title)

LEA Designated Person

Maintenance and Operations

SECTION 9

COST ESTIMATION

SECTION 10

SIGNED STATEMENT BY DESIGNATED PERSON

**Local Education Agency (LEA) General Responsibilities
Under AHERA**

Pursuant to Section 763.84 and Section 763.93 of the EPA Asbestos in Schools Regulations (40 CFR, Part 763), each Management Plan must contain a true and correct statement signed by the LEA designated person, that certifies that the general LEA responsibilities have been met. This form is provided to assist you in complying with this portion of AHERA.

LEA Name: KYRENE SCHOOL DISTRICT NO. 28

LEA Address: 14841 SOUTH 41ST PLACE, PHOENIX, ARIZONA 85044

Designated Person Name: GIACOMO MUSELLA, FACILITIES SUPERVISOR

Designated Person Address: 8700 SOUTH KYRENE ROAD

TEMPE, ARIZONA 85284-2197

ASSURANCES

1. This AHERA Management Plan was developed and has been submitted pursuant to the Asbestos Hazard Emergency Response Act of 1986, Public Law 99-915; and the United States Environmental Protection Agency Rule; Asbestos-Containing Material in Schools, 40 CFR, Part 763; and the undersigned does hereby certify that the LEA has and will ensure the following:
2. The activities of any persons who perform inspections, reinspections and periodic surveillance, develop and update management plans, and develop and implement response actions, including operations and maintenance, are carried out in accordance with Part 763.
3. All custodial and maintenance employees are properly trained as required in Part 763 and all other applicable Federal and/or State regulations (e.g., the Occupational Safety and Health Administration Asbestos Standard for Construction, the EPA Worker Protection Rule or applicable state regulations).
4. All workers and building occupants, or their legal guardians, are informed at least once each school year about inspections, response actions, post-response action activities, including period reinspection and surveillance activities, that are planned or in progress.
5. All short-term workers (e.g., telephone repair workers, utility workers or exterminators) who may come in contact with asbestos in a school are provided information regarding the locations of ABM and suspected ABM assumed to be ACM.
6. All warning labels are posted in accordance with Section 763.95.
7. All management plans are available for inspection and notification of such availability has been provided as specified in the management plan under Section 763.93(g).
8. The undersigned person designated by the LEA pursuant to Section 763.84(g)(1) has received adequate training as stipulated in Section 763.84(g)(2).
9. The LEA has and will consider whether any conflict of interest may arise from the interrelationship among accredited personnel and whether that should influence the selection of accredited personnel to perform activities under Part 763.

Signature

LEA Designated Person, pursuant to 40 CFR 763.93(l) and 763.84

Date

SECTION 11

ANNUAL NOTIFICATION

**Annual Notification
763.93(g)(4)**

SAMPLE

(Date)

Dear Occupants:

As you may recall, this facility has had an asbestos survey completed and an Operations and Maintenance (O&M) Program developed. The survey documents the areas that contain asbestos-containing building materials (ACBM), and the O&M Program provides the data needed to maintain ACBM in good condition until its eventual removal. The survey and O&M Program are located in the Asbestos Program Manager's office, 8700 South Kyrene Road, Tempe, Arizona 85284-2197, and are available during office hours to anyone for review.

Inhalation of asbestos fibers can be harmful. When ACBMs are maintained in good condition, the potential hazard diminishes and ACBMs may be kept in-place for the life of the building or until renovation could disturb them.

To avoid exposure to airborne asbestos fibers, it is important to: (1) know what types of materials may contain asbestos, (2) avoid damaged areas of these materials, and (3) contact the building management when damaged areas are found. Common applications of asbestos in buildings have included spray-applied fireproofing, soundproofing, thermal insulation, acoustic plaster soundproofing or ceiling tiles, pipe insulation, asbestos cement board (transite), vinyl asbestos tile, tile mastic, linoleum and backing, and roofing materials.

Most buildings built between 1950 and 1970 contain some of these materials, but it is important to realize that not all of them contain asbestos. The survey pinpoints ACBM and their locations throughout the building.

In order to prevent potential release of asbestos fibers, any activity which may disturb these materials must be approved by the Asbestos Program Manager. Please contact facility management concerning any damaged or disturbed areas.

Asbestos Program Manager's Name: _____ **(Enter Name)**
Location: _____ **(Enter Location)**
Telephone Number: _____ **(Enter Telephone Number)**

When feasible, we will remove some or all of the asbestos-containing building materials. All work is being done to comply with relevant federal and state laws. Much of the work is done during off hours to further protect building occupants from exposure.

Should you have any questions or comments, please contact the facility management.

Sincerely,

(Name)
Asbestos Program Manager
Kyrene School District No. 28

SECTION 12

**ACCREDITATION STATEMENT
FOR ADDITIONAL CONSULTANTS**

APPENDIX A

ONGOING RECORDKEEPING
